

|CURIEUX|

---

ACADEMIC JOURNAL

**August Issue**

Part 1 Issue 41

Editing Staff

**Chief-In-Editor**

Caroline Xue

George Hasnah

**Chief of Operations**

Anshal Vyas

**Assisting Editors**

Olivia Li

Luzia Thomas

Madalyn Ramirez

Shefali Awasthi

Soumya Rai

Sarah Strick

## **Table Of Contents**

**Page 7: Leveraging Nanoparticles to Boost Antigen-Presenting Cell Efficacy in Immunotherapy by Medha Nalakonda**

**Page 28: Unraveling the Net Worth: Exploring Financial Disparities and Diversity Deficits in Tennis By Finn Johnson**

**Page 36: The Fear of Learning: The Interplay between Adrenaline and Neuroplasticity By Victor Zheng**

**Page 46: An Evaluation of Artificial Intelligence's Impact on the Workplace and Economy by Melanie Cheung**

**Page 71: The Effects of Lotion Sunscreen Compared to Spray Sunscreen in Protecting the Skin from Skin Cancer Caused by UV Radiation Using Yeast Cells by Abigail Truong & Karl Martens**

**Page 76: Utilizing ChatGPT to Determine a Plant's Watering Schedule and Automatically Administer Water via a Motor-Based Valve by Sophia Dong and Emmanuel Mayssat**

**Page 88: Homecoming of Refugee Children by Maryam Ali**

**Page 93: Exploring Prenatal Factors Linked to Autism Spectrum Disorder By Mila Sonkin**

**Page 104: Colonialism's Lasting Legacy in Trinidad and Senegal By Vivaan Alleyne**

**Page 117: Medicinal Chemistry: Past, Present, Future, and Impacts on ADHD Treatment - A Review By Lisa Jin**

**Page 131: Glutamate and GABA Neurotransmitters During an Ischemic Stroke and the Recovery Process By Jeremy Ratner**

**Page 140: Biological Applications of Graphene Family Nanomaterials By Eric Tam**

**Page 151: The Role of Platinum in the Green Energy Revolution by Nicholas C. Burgess**

**Page 174: Can We Predict Ozone Loss from Wildfires Using Satellite Products? Asura, Xinyu Tian**

**Page 183: Force Lab by Nandini Kolli, Kelley Ann Bethoney**

**Page 190: An Examination in the Components of Music as it Relates to the Efficacy of Music Therapy by Luke Xu**

**Page 200: Quantum Mechanics and the Wave Function by Dhairya Jaswani**

**Page 218: Tracing Back Lines in the Sand: The Forces Behind the Sykes-Picot Agreement by Filiz Fish**

**Page 226: Unmasking Norval Morrisseau's Forgeries: Cultural Appropriation by Austin Liu**

**Page 235: The Connection Between School Shooters and Adverse Childhood Experiences By Navya Saravanakumar**

**Page 241: Adelaide Smith Casely Hayford: Charisma and Circumstance by Lyanne Luu**

**Page 249: Effect of Inactivation of MAPT Through Gene Knockdown on Tumor Invasion and Microtubule Stability in Prostate Cancer Cells by Luke Chen**

**Page 265: Supervised Machine Learning for Tweet Sentiment Analysis By Yuvika Verma**

**Page 278: Solar Photovoltaic Carport Solution to Energy Needs in Humanitarian Aid Situations By Omar Wali**

**Page 300: British Colonization as the Fundamental Cause of the Ogaden War By Julia Bae**

**Page 309: Modeling Lunar Landing via Deep Learning and Reinforcement Learning Methods by Saaketh Suvarna**

**Page 321: Harmonizing with the Mind: Exploring the Influence of Music Genres on the Mood and Behaviors of Psychopaths by Juliet Proscope**

**Page 333: Optimization of Tokamak Blanket Design to Minimize Neutron Flux on Magnets by Steven Benny**

**Page 342: The Great War's Toll: The Economic Collapse of the Ottoman Empire by Derin Değerli**

**Page 354: Mental Health Impacts of COVID-19 During the 2020-2021 Pandemic by Purvi Kumar**

**Page 362: A Literature Review Of How Monoclonal Antibodies Treat Lesional Skin In Atopic Dermatitis And A Proposal Of An Anti-inflammatory Therapy Approach Targeting CCL22's Binding To CCR4 By Aisha Weththasingha**

**Page 369: The Role of Women in STEM in WWII by Catherine Zeng**

**Page 376: The Influence of User-Generated Content on Brand Perception in Social Media Shopping - Cross-Cultural Analysis by Gretel Garcia**

**Page 389: Gender Bias in Machine Learning and Language Models Anya Gupta**

**Page 400: Enhancing Sustainability and Efficiency of Express Delivery Services in China: Oversight and Integration by Chengrui Yu**

**Page 417: Navigating Balance: Individual Rights vs. Government Regulations by Tanchanit Keerasuntonpong**

**Page 421: The Doomscrolling Epidemic: Influence of Short-form Social Media Content Political Polarization By Stan Cho**

**Page 440: Unraveling The Mystery Of Medicine Effectiveness: A Comprehensive Analysis by Kurlus Kurlus**

**Page 450: Relationship Between Social Intelligence and Bullying Behavior in Global Education City By Eunji Choi**

**Page 466: Enhancing Driver Efficiency By Nia Alavandi**

**Page 472: Assessment of different sectors impact on S&P500 using statistical modeling By Rohan Jha<sup>1,\*</sup> and Rishabh Jha<sup>2</sup>**

**Page 480: The Medical and Psychological Influence of Visual-Based Social Media on Adolescent Girls' Body Image By Mary Spain**

**Page 484: Period Products: America's Hidden Economic Injustice By Mary Spain**

**Page 490: Precision in Prediction: A Comparative Analysis to Optimize LSTM Models for Stock Prices By Darsh Jaganmohan**

**Page 504: Diet Habits Among High Schoolers in New York City Public High Schools Correlation With Academic Performance By Ayan Najam**

**Page 520: An Epigenetic Insight into Chronic Obstructive Pulmonary Disease: From DNA Methylation Mechanisms to Therapeutic Strategies by Trisha Karthi<sup>1\*</sup>**

**Page 542: Aeronautics and Astronomy: An indirect application, in the measurement of physical parameters of Moon - Mass, Density, and Surface Gravity using the Apollo and Chandrayaan Mission's flyby/orbits data by Ivanya Kabir and Madhva Fakare**

**Page 556: The Evolution of Stigma as it Relates to OCD and Suggestions for Stigma Reduction in the Future By Noah Kang**

**Page 571: Road Detection in Autonomous Vehicles through Deep Learning By Soeun Lee**

**Page 581: Precision Medicine for Lung Cancer: Exploring the Efficacy and Advances of Antibody-Drug Conjugates By Advaith Dinesh**

**Page 598: Daniel Inouye: Personal Justice Attained by Iris Lu**

**Page 600: How the Association of Soil Quality with Economic Stratification Affects Sustainable Landscaping By Romir Jain**

**Page 617: A Comparative Analysis of Counting Systems in Goidelic and Brythonic Celtic Languages By Vishrut Mehrotra**

**Page 627: Transforming Ground Search and Rescue Rover By Jonathan Peng**

# **Leveraging Nanoparticles to Boost Antigen-Presenting Cell Efficacy in Immunotherapy by Medha Nalakonda**

## **Abstract**

Nanoparticles play a pivotal role in revolutionizing immunotherapy, particularly in targeting antigen-presenting cells (APCs) to induce a robust cell-mediated immune response. Some of the foundational cell types include dendritic cells, macrophages, and the B cell. APCs are considered to play an essential role in mediating and controlling immune responses; nanoparticles represent a refined method to modulate APC activation. Lastly, it cannot be overemphasized that nanoparticle matter can influence the type of APC and this depends on the design of the nanoparticles; their materials, size, shape as well as surface modifications. By modulating these characteristics one gets to control the way nanoparticles interact with the APCs to eventually alter the immune response. For instance, nanoparticles can be used in targeting APCs where the antigens or therapeutic agents can be delivered efficiently with a subsequent increase in antigen presentation and boosting of T cell activation. This level of control of the immune system is very useful especially when designing immunotherapies that are dramatically more effective with fewer or no side effects.

## **1. Introduction**

Nanoparticles (NPs) are small particles that typically range in size from 1 to 100 nanometers. They may be composed of various materials including polymers, metals, lipids, or proteins (Figure 1). All kinds of NPs play a crucial role in drug delivery, especially through improving stability and solubility of the encapsulated cargo, the therapeutic substances loaded in the NPs<sup>1,2</sup>. Encapsulating drugs in NPs improves drug permeability through cell membranes, initiates intracellular trafficking, and controls biodistribution around the body<sup>3,4</sup>. NPs contribute to increased safety and efficacy in drug delivery by protecting the loaded drug, although their potential is limited by heterogeneity, which is often overlooked in research<sup>3</sup>. A variety of drug cargoes can be delivered using different NP structures, including proteins, nucleic acids, lipophilic drugs, DNA strands, and RNA strands. Designing nanoparticles with diverse properties and structures to surmount such barriers is an area of immense interest among scientists seeking versatile platforms to optimize drug delivery.

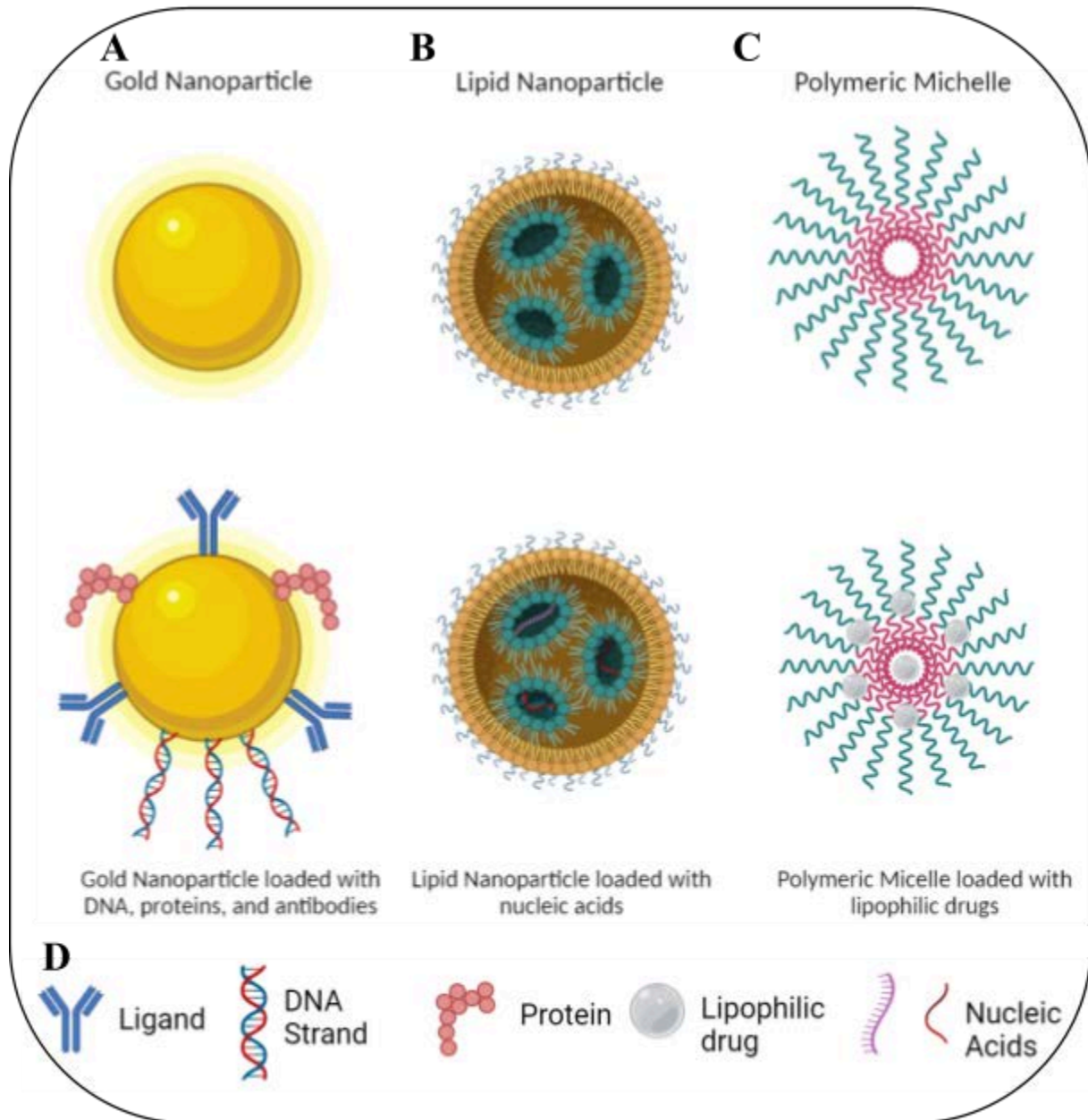

Fig 1: (A) Cartoon schematic of an unloaded(top) gold NP and a gold NP loaded with DNA, proteins, and antibodies on its surface (bottom). (B) Cartoon schematic of an unloaded(top) lipid NP and a lipid NP loaded with nucleic acids(bottom). (C) Cartoon schematic of an unloaded(top) polymeric micelle and a polymeric micelle loaded with lipophilic drugs(bottom). (D) Legend of different nanoparticle cargo. Made with BioRender.

NPs are frequently used to deliver immunotherapies, which engineer the immune response to treat disease. The immune response is a set of intricate biological processes that shield the body from invading harmful pathogens like bacteria, viruses, and parasites as well as



cancer cells. This defense system employs several mechanisms, which enable it to identify and destroy any foreign intruders while preserving self-tolerance<sup>3</sup>. There are two types of immune responses: innate and adaptive immunity. Innate immunity includes immediate, non-specific defense mechanisms like physical barriers, such as skin tissue and mucosa, inflammation, and white blood cells like macrophages and neutrophils<sup>4,5</sup>. Conversely, adaptive immunity is antigen-specific due to lymphocytes recognizing certain antigens which results in antibody production or memory development in immunological memory<sup>4,5</sup>. Immunotherapy harnesses the power of the immune system to treat diseases, particularly cancer, by either stimulating the immune response or suppressing the mechanisms that inhibit it. This includes treatments such as checkpoint inhibitors, monoclonal antibodies, and adoptive cell therapy, which aim to enhance the body's ability to recognize and destroy cancer cells<sup>6</sup>. Recently, NPs have been widely utilized to deliver immunotherapies, prompting massive research investment in engineering new NPs and characterizing their drug delivery performance.

Here, we explore the role of NPs in delivering immunotherapies and describe their interactions with the immune system, specifically antigen-presenting cells (APCs) like macrophages, dendritic cells, and B-cells. Overall, this review presents an opportunity for using NPs in developing novel therapeutic approaches aimed at eradication of cancerous cells within the human body.

## **2. Immune Response**

The human body's immune response is its mechanism for defense against harmful pathogens. It comprises the innate, nonspecific defenses that act immediately, and the adaptive defenses, which are more specific and take a longer time before they become effective. The latter include mucosa and skin tissue, phagocytic cells, and inflammatory responses<sup>7</sup>. On the other hand, the adaptive immune system offers a specific and targeted response, involving specialized cells like T and B lymphocytes, while occurring over a longer period of time—four to seven days<sup>7</sup>. These cells attack pathogens specifically, while adaptive immunity has an anamnestic memory of prior exposure that enables faster and better defense<sup>4</sup>. T and B lymphocytes are introduced to cancerous cells through the delivery of certain antigens with the help of specialized APCs, like dendritic cells. Antigens can be classified as either foreign or self. Foreign antigens can be parts of microorganisms or toxins produced by these microorganisms. Self-antigens originate within the body and are tolerated by the immune system. The immune system is moderated by Major Histocompatibility Complex (MHC) class I and class II proteins<sup>8</sup>. These proteins release specific peptides that allow for the presentation of antigens to T and B cells. MHC class I proteins have peptides derived from intracellular pathogens which are described as self-antigens<sup>9,10</sup>. Additionally, this permits T-cell receptors to distinguish harmful cells in the body from the infected ones. Conversely, MHC class II proteins present peptides from extracellular pathogens on T-cells' surfaces leading to the recognition of foreign cells within the body<sup>10</sup>. However, these MHC class II proteins are primarily expressed on the surfaces of APCs such as dendritic cells (DCs), macrophages, and B-cells.

APCs are encountered in different parts of the body and they are on constant surveillance for foreign elements<sup>11</sup>. DCs reside in the skin tissue to validate the presence of antigens as part of a pathogen that can harm a human being. These cells capture, process, and present antigens to T-cells, mainly CD4+ cells, which help induce immune responses against pathogens<sup>12</sup>. Type two conventional dendritic cells (cDC2s) are more efficient in presenting soluble antigens and long peptides than cellular antigens<sup>13</sup>. Capturing and presenting antigens are among several mechanisms employed by APCs to enhance host immunity while avoiding autoimmune attacks toward self-antigens<sup>14</sup>. Another type of molecule produced by T-cells is cytokine which functions as signaling factors interacting with B-cells. Different types of cytokines depend upon the nature of the immune response required for obliterating all detrimental cells within the system. These signals induce B-cell activation and differentiation. The plasma cells develop from some B-cells which synthesize antibodies against the recognized antigens and then release them into circulation. These antibodies circulate in the bloodstream and other body fluids, ready to bind to and neutralize the corresponding antigens.

The study of such APCs is significant in immunology since they have a central role in immune responses. They are important to immunotherapy because of their multiple faces in regulation and the possible impact on new immunotherapeutic approaches. DCs for example, not only initiate immune responses but also contribute to the maintenance of immune tolerance. However, DCs are needed critically for the coordination of adaptive immune response as well as modulation of other immune cells<sup>45</sup>. Among them, cDC2s can induce Regulatory T Cells (Tregs) which suppress over-activation of immunity and prevent autoimmune reactions<sup>15</sup>. Consequently, nanoparticles are often combined with improved functionality of DCs and other APCs. In NP-based immunotherapies, the NP interactions, particularly with DCs, must be understood to achieve powerful and targeted immunity minimizing off-target effects.

Immunotherapy leverages the immune system's existing infrastructure to target and destroy cancer. Immunotherapies can be precisely delivered through NPs. Cancer immunotherapy primarily involves APCs, which capture antigens and present them to B and T cells for immune response initiation. These antigens are found throughout the body and lead to cancer cell elimination. Additionally, NPs enhance the capabilities of APCs by delivering drugs, molecules, and antigens to APCs. Immunotherapy strengthens the APC function by enhancing the immune system's ability to identify and attack cancerous cells.

### **3. Nanoparticles**

#### **3.1 Metallic Nanoparticles**

MNPs are composed of metals like gold, silver, platinum, iron, and copper. (Figure 1A). Due to consisting of smaller molecules and having a high surface area, these MNPs have unique physical and chemical properties, which make them particularly useful in immunotherapy. Due to their wide range of modifiable characteristics, MNPs can be easily altered, which makes them efficient delivery mechanisms<sup>18-20</sup>. In addition to being used in imaging processes within the body, MNPs are generally used as catalysts for initiating the immune response and sensing

pathogenic microorganisms during immunotherapy<sup>21</sup>. The catalytic properties of MNPs are especially useful during immunotherapy as it allows the immune system to act against diseases and harmful pathogens in the body by directly delivering antigens to cancer cells. Vines et al. leveraged Gold nanoparticles (AuNPs) in photothermal therapy for cancer treatment, using their ability to efficiently absorb and emit light<sup>22</sup>. These help in the selective destruction of cancer cells by converting light energy into heat<sup>4</sup>. In using biological molecule detectors too AuNPs are employed therefore. They play a role in imaging as contrast agents and drug delivery carriers alike. AgNPs are also another type of MNP that is commonly used and often referred to as silver nanoparticles (AgNPs). These nanoparticles possess antimicrobial properties which are widely used in medical applications against bacteria and viruses. Bacterial cells suffer from oxidative stress protein malfunctioning and DNA damage from AgNPs' small size and large surface area<sup>23,24</sup>. These effects of silver AgNPs inhibit further microbial growth which prevents tumours from forming in the body. Like AuNPs, AgNPs' ability to interact with light and other materials makes them suitable for medical imaging<sup>25</sup>. Copper nanoparticles (CuNPs) greatly depend on size as their high surface-to-volume ratio makes them highly reactive. CuNPs also serve as catalysts for the immune response system in addition to being great conductors of electricity<sup>26,27</sup>. CuNPs also have antimicrobial properties, but they are less potent than the ones in AgNPs. Finally, iron-oxide nanoparticles (IONPs) are made up of both iron and oxygen atoms and are highly reactive like CuNPs. IONPs are also attracted to magnets, but they don't retain magnetism themselves when in the absence of a magnetic field<sup>27</sup>. Furthermore, IONPs serve as the means of transport for precision therapy and also generate heat like AuNPs that destroy cancerous cells. The variety of MNPs offers specific advantages making them useful for various technological or scientific purposes as shown in Table 1.

<b>Metallic Nanoparticle Type</b>	<b>Gold</b>	<b>Silver</b>	<b>Copper</b>	<b>Iron-Oxide</b>
Composition	Au	Ag	Cu	IO
Biocompatibility	Moderate	Moderate	Moderate	Moderate
Biodegradability	Low	Low	Low	Low
Functional properties	Optically active, imaging contrast agents, efficient light interaction	Antimicrobial <sup>25</sup> , oxidative stress induction, protein dysfunction, DNA damage in	Antimicrobial <sup>25</sup> , highly reactive, conductors of electricity	Highly reactive, attracted to magnets, serve as contrast agents in Magnetic

		bacteria, medical imaging		Imaging, heat generation
Loading abilities	Moderate amounts: proteins, nucleic acids, small molecules	High amounts: proteins, nucleic acids, small molecules	Moderate amounts: proteins, nucleic acids, small molecules	Moderate amounts: proteins, nucleic acids, small molecules

Table 1: Compares the characteristics of gold NPs, silver NPs, copper NPs, and iron-oxide NPs.

In immunotherapy, MNPs are often engineered to carry a large amount of cargo, such as antigens or other immune-stimulating molecules. Evans et al. discussed how MNPs, due to their ability to target the spleen and lymph organs and the relevant immune cells, can catalyze the immune system's recognition abilities to target specific cells<sup>4</sup>. MNPs' enhanced permeability and retention allow them to accumulate in tumors which is beneficial for delivering cancer immunotherapy treatments<sup>4</sup>. MNPs can also be effectively used to deliver immune adjuvants, which trigger robust immune responses against cancer cells. Moreover, MNPs can be manipulated using external magnetic fields, allowing for precise control over the movement and concentration of therapeutic agents within targeted tissues. This capability is especially useful in ensuring that the immunotherapeutic agents are delivered efficiently and accurately to the desired locations<sup>28</sup>. Additionally, metallic nanoparticles can be used to modulate the immune system, suppressing inflammatory responses in autoimmune diseases or enhancing immune responses in vaccination<sup>29</sup>.

### 3.2 Polymeric Nanoparticles

Another class of NPs that are widely used is Polymeric NPs. These NPs are synthesized from natural or synthetic monomers or preformed polymers. These various materials allow for several possible structures and characteristics of polymer NPs. Due to their high biocompatibility and simple formulation parameters, polymer NPs are commonly preferred for delivery<sup>30</sup>. The therapeutic cargo is entrapped in the polymer matrix within the NP's core. While the therapeutics can be physically bound to a polymeric NP's surface, they can also be chemically conjugated to the polymer itself as shown in Figure 2. This conjugation allows for a controlled release of the therapeutic and also serves as extra protection to ensure that the cargo does not fuse with other cells in the body. In addition, a polymer NP's ability to deliver multiple drugs makes it favorable for co-delivery applications<sup>31</sup>.

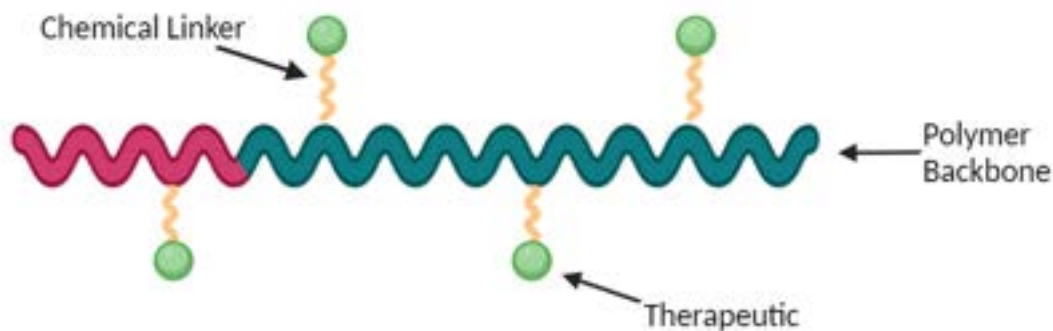

Fig 2: Display of one of the ways drugs are loaded into a polymeric nanoparticle before delivery(chemical conjugation). The therapeutics become chemically linked to the polymer backbone on the nanoparticle's surface. Made with BioRender.

Polymer nanoparticles are usually found in the form of nanocapsules and nanospheres but can be further divided into different shapes such as polymersomes, similar to liposomes<sup>32</sup>. Nanocapsules are formed by a thin polymeric envelope and carry the dissolved drug in its oily core. This nature of the oil-based core influences the small size of nanocapsules due to its hydrophobicity between the different liquid phases. They are surrounded by a polymeric shell that administers the release of the cargo. Nanospheres, on the other hand, have a spherical shape and are structured like a continuous polymeric network that contains the drug<sup>32</sup>. Another category of polymeric NPs is dendrimers. Dendrimers have central cores that give rise to controlled sequential branching. This way of adding new branches or layers to the core leads to unique symmetry and monodispersity, which gives them uniform size distribution among other advantages. Dendrimers can be designed with biocompatibility in mind, and their surface properties can be changed to minimize toxicity<sup>33</sup>. PEGylation (attachment of polyethylene glycol) is widely used to improve the compatibility between dendrimers and blood as well as enhance their circulation time in it<sup>34</sup>. Moreover, it allows for the fine-tuning of outer surface properties by functionalizing with various groups. These branches provide a versatile platform for drug delivery systems, imaging agents, and gene delivery<sup>35</sup>.

Dendrimers have been studied for gene delivery applications, which is a specific form of immunotherapy. Dendrimers' positively charged surfaces can easily bind with negatively charged DNA, which in turn aids efficient gene delivery into cells. Polymers' molecular weight and DNA loading optimize the formulation of polymeric nanoparticles to define encapsulation efficiency and release kinetics. For example, cationic polymers are specially designed polymers that are appropriate for DNA delivery thanks to their ability to encapsulate complex mixtures and specific sequences<sup>33</sup>. Upon delivery, these NPs can facilitate the release of DNA into target cells through mechanisms such as surface functionalization, electrostatic interactions, or triggered release in response to environmental cues<sup>36</sup>. Apart from DNA, dendrimers can hold many other types of cargo, such as therapeutics, nucleic acids, and small molecules, due to their ability to encapsulate drugs within their internal voids or attach drugs to their surface. They also transport charged polymers like polyamidoamine (PAMAN) which are highly branched macromolecules.

It could be used for drug conjugation or encapsulation because of the branches as well as terminal amine groups, thus resulting in efficient loading of therapeutic agents. There is a possibility to synthesize PAMAN dendrimers with precise control over their size and molecular weight. The latter can be used to produce nanoparticles with uniform properties that are necessary for reproducibility and scalability<sup>37</sup>. This then implies that these dendrimers have a high surface-to-volume ratio hence a great number of functional groups at which drugs can bind thus making them suitable for delivery of different types of therapeutics including small molecules, nucleic acids, and proteins. A targeting ligand, imaging agent, or stimuli-responsive moiety could be attached to the PAMAN polymer nanoparticle to attain tissue-specific activity, improve imaging capabilities, or release the drug in response to external stimuli. This occurs when the NPs undergo enzymatic degradation which is a controlled release mechanism that can improve drug efficacy and minimize systemic side effects by reducing drug exposure to non-target tissues<sup>38</sup>. Even though these nanoparticles are a versatile platform for drug delivery they can be considered dangerous due to their varying degrees of biocompatibility, which can induce cytotoxicity<sup>39</sup>.

While PEG NPs are also used as delivery agents, they are more widely known for their various attributes related to reducing protein adsorption, minimizing immune responses, and prolonging circulation time in blood stream<sup>40</sup>. PEG polymer nanoparticles have the capacity to encapsulate drugs within their structure which protects the drug from degradation *in vivo*, enhances its solubility, and improves its stability in biological environments<sup>40,41</sup>. Additionally, PEG polymers can be modified to have specific chemical properties that facilitate the loading and release of drugs. The surface of PEG polymer NPs contains targeting ligands that control selective binding to receptors overexpressed on diseased cells, which also enhances the NP's specificity for the target tissue. One of the main benefits of PEG polymer nanoparticles is that they can avoid detection by the immune system and remain in the bloodstream for a longer time. This behavior called "stealth" results from the water-soluble nature of PEG, because it decreases interaction with blood components and avoids recognition by the immune system, making these particles last longer<sup>42</sup>. Moreover, this controlled architecture enables fine-tuning of surface functionalities of dendrimers which helps improve therapeutic efficacy and makes them a potential class of polymeric nanoparticles for delivery processes.

Polymeric nanoparticles, moreover, have shown considerable potential for immunotherapy approaches as they can be modified to encapsulate different types of immunotherapeutic agents and also shield cargo from mechanical obstructions<sup>41</sup>. Polymeric nanoparticles could also be engineered to overcome these barriers which would enable such therapies to be taken where it had not been possible before. On arriving at their desired locations polymeric nanoparticles may be modified for controlled release kinetics so that immune cells are consistently exposed to therapeutic molecules resulting in a sustained immune response<sup>40</sup>. Furthermore, their external surface can be tailored to interact with APCs promoting antigen presentation as well as T-cell stimulation<sup>32</sup>.

A polymer nanoparticle's biomimetic nature and stability during storage enhance its appeal, while the ease of modification allows for targeted drug delivery. Even with its wide variety of applications, polymer nanoparticles come with certain disadvantages, such as an increased risk of particle aggregation and potential toxicity concerns. Due to these effects, there are many limitations placed on the type of polymer nanoparticles by the FDA.

### 3.3 Lipid-Based Nanoparticles

Liposomes are some of the most used nanocarriers due to their inert abilities to be readily internalized by the cells in the human body because of their similar chemical compositions to cell membranes. Liposomes also easily encapsulate nucleic acids and provide a smooth transition into the cancer cells. Liposomes also have the unique property of successfully entrapping hydrophilic and lipophilic compounds in the same system due to their layered structure to carry multiple medicines<sup>39,40</sup>. Its properties also extend to having high biocompatibility, biodegradability, and low immunogenicity<sup>43,44</sup>. On the other hand, Lipid nanoparticles (LNPs) are commonly utilized in the delivery of nucleic acids. LNPs are different from traditional liposomes as they form a micelle-like structure in the particle's non-aqueous core as mentioned in Figure 4<sup>45</sup>. LNPs are composed of cationic or ionizable lipids with negatively charged genetic material and phospholipids that contribute to the particle's structure, cholesterol for stability and membrane fusion, and PEGylated lipids for stability and circulation<sup>46,47</sup>. This combination allows for improved drug encapsulation and controlled release. Nanostructured lipid carriers (NLCs) are a specific type of LNP that consists of a blend of solid and liquid lipids. The inclusion of liquid lipids in NLCs enhances the stability of the particle under various storage conditions while also providing a more flexible lipid matrix<sup>50</sup>. All forms of LNPs major in personalized genetic therapy applications due to the efficacy of their nucleic acid delivery, simple synthesis process, and small size and serum stability which enables them to pass through barriers<sup>48,49</sup>.

Solid lipid nanoparticles (SLNs) are also useful for drug delivery, especially for hydrophobic drugs, as they combine the characteristics of polymeric nanoparticles and liposomes<sup>51</sup>. SLNs are composed of solid lipids and are typically saturated fatty acids or waxes that remain solid at physiological temperatures. These particles are commonly spherical and have a solid lipid core matrix coated with phospholipids, similar to polymeric NPs. The biocompatible lipids allow SLNs to reduce toxicity, making them safe for clinical applications like liposomes. Additionally, they may contain surfactants, ionic and nonionic polymers, and organic salts as emulsifiers. The structure and interaction between lipid molecules, surfactants, and co-surfactants significantly impact the crystallization process and the long-term stability of the aqueous SLN dispersion. SLNs may face limitations in terms of drug loading capacity due to their solid lipid core. While this issue exists, Duan et al. demonstrated that this low loading can lead to faster release kinetics from SLNs when loaded with a hydrophobic drug<sup>52</sup>.

While both SLNs and LNPs are among the most commonly used nanoparticles, they are limited by low drug loading and biodistribution. This can cause side effects of high uptake to the liver and spleen which may result in the formation of mimicked cancerous tumors<sup>7</sup>. More

importantly, this limitation results in LNPs consistently ending up in the liver or spleen, making it difficult to target certain areas of the body for the execution of the precision treatment.

<b>Lipid-Based Nanoparticle Type</b>	<b>Liposomes</b>	<b>Lipid Nanoparticles (LNPs)</b>	<b>Solid Lipid Nanoparticles (SLNs)</b>
Composition	Phospholipid bilayer	Cationic or ionizable lipids, nanostructured lipid carriers (NLCs), phospholipids, cholesterol, PEGylated lipids	Solid lipids, phospholipids, surfactants, polymers, emulsifiers
Structure	Layered	Micellar in the particle core	Spherical solid lipid core matrix coated with phospholipids
Compatibility	High with hydrophilic and lipophilic compounds	Suitable for nucleic acid delivery	Useful for hydrophobic drugs
Drug Encapsulation	Multiple medicines	Improved encapsulation and controlled release	Drug loading capacity may be limited
Limitations	Low drug loading, biodistribution issues	Low drug loading, biodistribution issues	Low drug loading, limited release kinetics

Table 2: Compares the characteristics of liposomes, lipid NPs, and solid lipid NPs.

#### **4. How Nanoparticles Can Affect Professional Antigen-Presenting Cells**

NPs play an important role in the body's immune response. Specifically, their unique characteristics and delivery mechanisms allow them to aid APCs in carrying out the antigens and catalyzing the immune response process as mentioned in Table 3.

##### **4.1 Nanoparticles and Dendritic Cells**

MNPs aid DCs in carrying out the antigens that T cells target and catalyzing the immune response. For example, in immunotherapy, metallic nanoparticles can engulf more antigens used



for pathogen targeting within the body due to their large surface area and high density<sup>11</sup>. Cytokines released by these DC-NP interactions may potentially cause inflammation that has an effect on the recruitment and activation of other immune cells. Therefore, they provide systemic immunity and stop the development of other malignant tumors<sup>53</sup>. Additionally, NPs can control DC maturation as well as activation, by determining future immune responses. They act as adjuvants enhancing immune responses which makes them valuable in vaccine development<sup>4</sup>. Such adjuvant-like characteristics promote the expansion of T-cells and the prevention of tumor growth<sup>4</sup>. In contrast, some NPs such as polymer nanoparticles address this issue by co-delivering antigens and adjuvants on a single particle<sup>13</sup>. In ablative therapy, which focuses on destroying diseased tissue while minimizing damage to surrounding healthy tissue, MNPs produce energy to heat up blood vessels that feed tumors hence opening more sluices for NPs and T cells<sup>4</sup>. This leads to specific antigens against cancer cell death as well as danger signals from the tumor microenvironment. These antigens are then captured by dendritic cells (DCs) which interact with T-cells in draining lymph nodes (DLNs). Liposomes and gold nanoparticles also present antigens and adjuvants, thus facilitating their uptake by DCs. Due to their property of surface modification, AuNPs can be coated with diverse molecules that enhance interaction with immune cells<sup>12</sup>. In addition, vaccine development often relies on various kinds of polymeric nanoparticles such as dendrimers and polyethylene glycols that can be engineered for targeted antigen delivery into DCs<sup>54</sup>. Cytotoxic T lymphocyte immune responses are stimulated via these processes. Nevertheless, the size, surface properties as well as composition of NPs also determine their toxicity affecting DC viability and function leading to enhanced stimulation of immune response thus offering promising avenues for immunotherapy development<sup>14</sup>.

<b>Antigen-Presenting Cell</b>	<b>Dendritic Cell</b>	<b>Macrophage</b>	<b>B-Cell</b>
Immune Response	Adaptive	Innate	Adaptive
Antigen Uptake	endocytosis and phagocytosis	Phagocytosis, receptor-mediated endocytosis	B cell receptor binding
Effector Function	Stimulate T cell activation and differentiation, promote immune response	Phagocytosis, cytokine secretion, inflammation modulation	Antibody secretion, memory cell formation, antigen presentation
Interaction with Other Cells	Primarily with T cells, but also with macrophages and	With other immune cells and non-immune cells	With helper T cells, other B cells, and antigen-presenting

	other dendritic cells		cells
Role in Immune Response	Initiators of adaptive immune response, bridge innate and adaptive immunity	Key players in innate immunity, tissue homeostasis, and inflammation	Central to humoral immunity and antigen recognition

Table 3: Table comparing characteristics and functions of each APC.

#### 4.2 Nanoparticles with Macrophages

The use of NPs can increase DC efficiency in immunotherapy to a great extent but when it comes to macrophages, they provide opportunities for the optimization of nanoparticle-mediated therapies. In immunotherapy, the role of macrophages, a type of white blood cell component of innate immunity, is crucial in many physiological processes such as immunity, tissue homeostasis, and inflammation<sup>15</sup>. M1 and M2 are two different categories of macrophages that have diverse roles in inflammation and cancer. M1 macrophages are classical activation macrophages involved in proinflammatory processes and antitumor immunity. They also produce high levels of pro-inflammatory cytokines, and reactive oxygen species among other molecules contributing to inflammatory responses and protection against foreign invaders<sup>39</sup>. In cancer therapy, M1 macrophages play a protective role by amplifying immune responses secreting factors that inhibit tumor growth and angiogenesis. M2 macrophages alternatively activated macrophages with anti-inflammatory activity in inflammatory diseases. These release anti-inflammatory cytokines which promotes tumor progression and poor prognosis via aiding tumor growth and invasion within the tumor microenvironment<sup>16,17</sup>.

Macrophages are usually linked with therapies relating to NPs. NPs can be modified at the surface to direct them toward these cells, thus revolutionizing disease treatment through the targeted delivery of therapy agents specifically meant for these types of immune cells. As a result of the highly phagocytic nature of macrophages that can engulf foreign particles such as NPs, NPs have the ability to enhance this process and resultantly increase therapeutic cargo uptake by such immune cells. This interaction could lead to variations in immune response inside macrophages thereby affecting the whole body's immunity. It also allows rapid AP activation due to up-regulated phagocytosis by NPs<sup>55</sup>. Macrophage states and functions have been regulated using engineered NPs. Some forms of NPS polarize macrophages into either pro-inflammatory (M1) or anti-inflammatory (M2) types depending on their intended use for treatment purposes. This modulation may be used to improve an immune response against cancer or dampen inflammation during autoimmune diseases. For example, in cancer immunotherapy, there are instances where nanoparticles are produced with properties that allow them to bind tumor-associated macrophages(TAMs), which tend to exhibit pro-tumoral functions most times. An alternative approach would be to directly deliver treatment in the form of either cytokines or chemotherapeutic agents that can suppress TAMs. These nanomaterials may redirect macrophages' responses from their pro-tumoral phenotype to anti-tumor one resulting in

enhanced efficacy of cancer treatment<sup>56,57</sup>. Such advances in immunotherapy are possible due to nanoparticles' ability to enhance phagocytosis and macrophage activation during macrophage-mediated therapies.

### **4.3 Nanoparticles with B-Cells**

As they do with dendritic cells and macrophages, nanomaterials play a pivotal role in modulating the functions of B cells, particularly in the context of antitumor immunity and vaccine development. Besides, gold nanoparticles (AuNPs) coated with polyethylene glycol (PEG) have been extensively applied to enhance humoral immunity to boost B-cell responses<sup>58</sup>. Moreover, functionalization of NPs with Toll-like receptor (TLR) ligands boosts their capacity to elicit muscular humoral responses in vivo. Unlike soluble antigens, NPs activate B cells by displaying antigens on their surface leading to a more rapid response time<sup>59</sup>. Thus, cancer cells can be directed while sparing normal tissues hence reducing systemic toxicity. This has increased the promise for nanomaterials as new mechanisms for actively targeting B-cell lymphoma—cancer that arises from B lymphocytes thereby demonstrating its prospects in cancer immunotherapy.

When introduced into the body, NPs tend to become concentrated in immune-rich organs such as the spleen and lymph nodes where they are taken up by specific subsets of B cells without affecting their viability or function<sup>60,61</sup>. There is enhanced uptake of NPs by activated B cells, making it possible to target modulation of B cell responses<sup>62</sup>. Importantly, NPs are inert and have no pro-inflammatory effects or interfering effect on immune reactions directed towards antigens; thus they are becoming suitable for manipulation of B cell function<sup>58</sup>. Furthermore, the interaction between gold nanoparticles and B cells specific to adaptive immunity suggests that these particles might be involved in antibody synthesis and immune memory development<sup>63</sup>. The vast range of properties exhibited by NPs promises significant improvements in vaccine design, immunotherapy techniques, and targeted drug delivery approaches to improve therapeutic outcomes while reducing undesirable side effects on the immune system caused by an uncontrolled B cell response.

## **5. Future Potential**

### **5.1 DNA-Based Nanoparticles**

There has been development in the design and construction of DNA-derived nanomaterials over the past few years. The peculiarities of DNA, like self-assembly recognition, allow for advantages such as being controllable or programmable, biocompatible, and easily modified<sup>64</sup>. As a result, they hold great potential as drug delivery systems, particularly in the context of tumor treatment.

The construction of DNA nanostructures is based on the principle of base complementary pairing. This eventually led to the development of DNA origami which opened doors to creating complex two-dimensional (2D) and three-dimensional nanostructures with increasing sophistication<sup>65,66</sup>. DNA nanobots have been built upon the original DNA origami technology,

exhibit dynamic mechanical functions, and hold the potential for precise drug delivery by navigating along designed paths to target lesions accurately<sup>67</sup>. DNA's inherent complementary base-pairing ability allows for the simultaneous loading of many different sizes and types of drugs and cargo, making it extremely versatile. Moreover, the ability to address DNA nanostructures sensitively allows the directing of charged molecules' valence and position. Besides that, it is possible to develop functional DNA nanosystems with highly complex three-dimensional structures, such as tetrahedral structures, cubic lattices, spheres, and other polyhedra. The advantages of DNA nanodevices include their biocompatibility, ease of synthesis, modifiability, and programmability<sup>67</sup>. They can effectively carry drugs with the aid of functional elements and achieve efficient delivery. Additionally, DNA nanodevices are preferred over other traditional delivery systems for instance; they can respond to a wide range of stimuli like light temperature magnetism hydrogen ion concentration enzyme level, and so on controlling releasing rate in drug lows being user-friendly while maintaining some stability and controllability to reduce the risk of toxic effects<sup>68</sup>. DNA nanodevices have shown potential in the delivery of drugs because they can bind specifically via high affinity to target molecules. They have tunable valence state controls due to their high controllability levels and hence can be used as carriers for multiple drugs at one time without interfering with or disturbing each other's functions. Furthermore, the synergistic combination of DNA nanomaterials and other nanomaterials, such as MNPs and nanorods, enhances therapeutic efficacy. Moreover, the potential of DNA nanoparticles in immunotherapy holds great promise for revolutionizing the treatment of various diseases. DNA NPs can also be engineered to carry specific genetic material that encodes for tumor antigens. By leveraging the precise targeting and programmability of DNA nanotechnology, we can develop more effective and personalized therapies that minimize off-target effects and maximize therapeutic outcomes. As research in this field continues to advance, DNA nanoparticles can offer innovative approaches for treating a wide range of diseases.

## **5.2 Future Potentials with Gene Editing**

Apart from these new discoveries for drug delivery, NPs hold immense potential for correcting various diseases through gene editing which is crucial in immunotherapy because it allows for the precise modification of immune cells to enhance their ability to recognize and attack cancer cells or pathogens, leading to more effective and personalized treatments. For example, using CRISPR-Cas9 or similar technologies, NPs can deliver gene-editing components directly to T cells, modifying genes to improve their ability to recognize and destroy cancer cells. This precision ensures that only the desired genetic changes are made, reducing the risk of off-target effects and increasing the efficacy of the therapy. Furthermore, NPs can protect these gene-editing components from degradation and facilitate their entry into cells, overcoming significant barriers that traditionally limit the efficiency of gene delivery systems.

However, these procedures encounter formidable extracellular and intracellular barriers when attempting to reach the genomes of target cells. Lipid nanoparticles have proved to help

these genome-editing technologies overcome these obstacles. Intracellular targeting in most NP-based genome-editing systems involves the electrostatic complexation of nucleic acids with cationic materials<sup>3</sup>. NPs participate in intracellular delivery which occurs through receptor-mediated endocytosis and phagocytosis, where systems are optimized for active targeting to enhance endocytic uptake in the intracellular environment<sup>69</sup>. Specifically, LNPs can influence intracellular trafficking passively, yet they can also be actively targeted to specific organelles. Apart from this, when genome engineering applications are addressing cystic fibrosis, gene therapy has failed to produce desirable results due to the mucus barriers that prevent NP delivery. There has been significant progress in creating muco-penetrating systems with smaller NPs than the mesh pore size of mucus with the incorporation of PEGylation. Moreover, utilizing genome editing techniques may enhance NP control and safety resulting in new solutions for complex genetic disorders<sup>70</sup>. Genome editing can make NPs have more accurate control, and reduce safety problems while giving means to tackle complicated genetic disorders that were previously difficult to address. At present, the scientific effort focuses on making NP designs better to use them at their best efficacy and safety levels in different therapeutic applications.

### **5.3 Limitations, Biological Barriers, and Future Directions**

Although nanoparticles present vast opportunities in various fields, there are challenges that need to be considered prudently. Many types of nanoparticles can cause toxicity or provoke an immune response; the biocompatibility, toxicity, and distribution of nanoparticles depend on their size, shape, surface charge, and composition processes. Nanoparticles can accumulate in specific tissues or organs leading to adverse effects such as organ failure or inflammation plus other complications in the long run due to their presence as foreign materials recognized by the immune system which compromises safety and effectiveness. Obstructions posed by mucus thickness or blood at physiological barriers can also limit penetration and delivery routes for nanoparticles<sup>3,71</sup>. This limitation can affect their efficacy in targeted drug delivery to specific sites within the body. The deficiency would render them ineffective for targeted delivery of drugs to specific sites within the body. Scientists have worked around this limitation by experimenting with various coatings on NPs so as to stop their identification as foreign materials. These protective coatings are made from polymer or silica shells which cover the NP surface area minimally, ensuring low contact with water and thereby reducing the release of toxic ions into the body<sup>72</sup>.

Beyond biological factors, production hurdles exist. Manufacturing certain NPs, especially those requiring advanced materials like metallic NPs, can be expensive, hindering widespread adoption<sup>73</sup>. Scaling up lab-made processes for industrial production presents its challenges in terms of consistency, quality control, and feasibility<sup>74</sup>. Researchers have turned to green synthesis processes for NP development to overcome this hurdle. Green synthesis is an environmentally friendly manufacturing procedure of NPs that allows for uniform production and prevents the use of chemicals that may be harmful to the human body. This new style of

assembling NPs has resulted in efficient use of resources as well as improved their biocompatibility with the human immune system during therapeutic applications<sup>75</sup>.

NPs may also struggle to reach specific targets within the body due to limited tissue penetration, potentially affecting their ability to deliver drugs effectively. Similar to other limitations, NPs can use specific particle coating to break through physical barriers. For mucin fibers, NP surfaces can be covered in hydrophilic materials to reduce the hydrophobic interactions between themselves and the mucin fibers<sup>76</sup>. By preventing such interactions, NPs will have enhanced mucus-penetrating ability, so they are not prevented from reaching their targeted sites. Avoiding mucin fibers is not the only biological barrier in the body, so a final solution for this issue has not been presented yet to be used for all types of NPs.

Finally, ethical and societal considerations are raised when discussing the potential of NPs. Issues surrounding privacy, informed consent, and equitable access to these technologies demand thoughtful solutions. By addressing these challenges, we can ensure that advancements in NP-enhanced immunotherapy are developed and implemented responsibly. Ultimately, the integration of nanoparticles in immunotherapy holds significant promise for revolutionizing cancer treatment.

## Works Cited

- Abbasi, E., Aval, S. F., Akbarzadeh, A., Milani, M., Nasrabadi, H. T., Joo, S. W., Hanifehpour, Y., Nejati-Koshki, K., & Pashaei-Asl, R. (2014). Dendrimers: Synthesis, applications, and properties. *Nanoscale Research Letters*, 9(1), 247.
- Afsharzadeh, M., Hashemi, M., Mokhtarzadeh, A., Abnous, K., & Ramezani, M. (2018). Recent advances in co-delivery systems based on polymeric nanoparticle for cancer treatment. *Artificial Cells, Nanomedicine, and Biotechnology*, 46(8), 1095-1110.
- Altammar, K. A. (2023). A review on nanoparticles: Characteristics, synthesis, applications, and challenges. *Frontiers in Microbiology*, 14, 1155622.
- Balan, S., Saxena, M., & Bhardwaj, N. (2019). Chapter One - Dendritic cell subsets and locations. In C. Lhuillier & L. Galluzzi (Eds.), *International Review of Cell and Molecular Biology* (Vol. 348, pp. 1-68). Academic Press.
- Begines, B., Ortiz, T., Pérez-Aranda, M., Martínez, G., Merinero, M., Argüelles-Arias, F., & Alcudia, A. (2020). Polymeric nanoparticles for drug delivery: Recent developments and future prospects. *Nanomaterials*, 10 (7), 1403.
- Berraondo, P., Martini, P. G. V., Avila, M. A., & Fontanellas, A. (2019). Messenger RNA therapy for rare genetic metabolic diseases. *Gut*, 68(7), 1323-1330.
- Bielinska, A., Kukowska-Latallo, J. F., Johnson, J., Tomalia, D. A., & Baker, J. R. (1996). Regulation of in vitro gene expression using antisense oligonucleotides or antisense expression plasmids transfected using starburst PAMAM dendrimers. *Nucleic Acids Research*, 24 (11), 2176-2182.
- Blanco, E., Shen, H., & Ferrari, M. (2015). Principles of nanoparticle design for overcoming biological barriers to drug delivery. *Nature Biotechnology*, 33 (9), 941-951.
- Bohrey, S., Chourasiya, V., & Pandey, A. (2016). Polymeric nanoparticles containing diazepam: Preparation, optimization, characterization, in-vitro drug release and release kinetic study. *Nano Convergence*, 3 (1), 3.
- Cheng, X., & Lee, R. J. (2016). The role of helper lipids in lipid nanoparticles (LNPs) designed for oligonucleotide delivery. *Advanced Drug Delivery Reviews*, 99, 129-137.
- Desai, N. (2012). Challenges in development of nanoparticle-based therapeutics. *AAPS Journal*, 14 (2), 282-295.
- Duan, Y., Dhar, A., Patel, C., Khimani, M., Neogi, S., Sharma, P., Kumar, N. S., Maji, S. K., & Karakoti, A. S. (2020). A brief review on solid lipid nanoparticles: Part and parcel of contemporary drug delivery systems. *RSC Advances*, 10(44), 26777-26791.
- Eliyahu, H., Barenholz, Y., & Domb, A. J. (2005). Polymers for DNA delivery. *Molecules*, 10 (1), 34-64.
- Engineering precision nanoparticles for drug delivery | Nature Reviews Drug Discovery. (2020). *Nature Reviews Drug Discovery*, 19, 491-508.  
<https://www.nature.com/articles/s41573-020-0090-8>.
- Eskelinen, A.-P., Rosilo, H., Kuzyk, A., Törmä, P., & Kostianen, M. A. (2012). Controlling the formation of DNA origami structures with external signals. *Small*, 8 (13), 2016-2020.

- Evans, E. R., Bugga, P., Asthana, V., & Drezek, R. (2018). Metallic nanoparticles for cancer immunotherapy. *Materials Today*, *21* (6), 673-685.
- Fenton, O. S., Olafson, K. N., Pillai, P. S., Mitchell, M. J., & Langer, R. (2018). Advances in biomaterials for drug delivery. *Advanced Materials*, *30* (29), e1705328.
- Frontiers | Advances and challenges of liposome assisted drug delivery. (2015). *Frontiers in Pharmacology*, *6*, 286.  
<https://www.frontiersin.org/articles/10.3389/fphar.2015.00286/full>.
- Freitas, C., & Müller, R. H. (1999). Correlation between long-term stability of solid lipid nanoparticles (SLN) and crystallinity of the lipid phase. *European Journal of Pharmaceutics and Biopharmaceutics*, *47* (2), 125-132.
- Gajewski, T. F., Schreiber, H., & Fu, Y.-X. (2013). Innate and adaptive immune cells in the tumor microenvironment. *Nature Immunology*, *14* (10), 1014-1022.
- Gardner, A., de Mingo Pulido, Á., & Ruffell, B. (2020). Dendritic cells and their role in immunotherapy. *Frontiers in Immunology*, *11*, 562420.
- Ghosh, P., Han, G., De, M., Kim, C. K., & Rotello, V. M. (2008). Gold nanoparticles in delivery applications. *Advanced Drug Delivery Reviews*, *60* (11), 1307-1315.
- Gold nanoparticles as a vaccine platform: Influence of size and shape on immunological responses in vitro and in vivo | ACS Nano. (2013). *ACS Nano*, *7* (5), 3901-3910.  
<https://pubs.acs.org/doi/10.1021/nn3057005>.
- Guan, C., Zhu, X., & Feng, C. (2021). DNA nanodevice-based drug delivery systems. *Biomolecules*, *11*(12), 1855.
- Hočevár, S., Šturm, S., Recek, N., Milani, M., Makovec, D., & Zupančič, E. (2022). PEGylated gold nanoparticles target age-associated B cells in vivo. *ACS Nano*, *16* (12), 18119-18132.
- Hu, G., Guo, M., Xu, J., Wu, F., Fan, J., Huang, Q., Yang, Y., Zhao, Z., Qiao, Q., & Yang, H. (2019). Nanoparticles targeting macrophages as potential clinical therapeutic agents against cancer and inflammation. *Frontiers in Immunology*, *10*, 1998.
- Huang, Z., Hua, S., Yang, Y., & Fang, J. (2008). Development and evaluation of lipid nanoparticles for camptothecin delivery: A comparison of solid lipid nanoparticles, nanostructured lipid carriers, and lipid emulsion. *Acta Pharmacologica Sinica*, *29* (9), 1094-1102.
- Kulkarni, J. A., Witzigmann, D., Leung, J., Tam, Y. Y. C., & Cullis, P. R. (2019). On the role of helper lipids in lipid nanoparticle formulations of siRNA. *Nanoscale*, *11* (48), 21733-21739.
- Kou, L., Sun, J., Zhai, Y., & He, Z. (2018). Transporter-guided delivery of nanoparticles to improve drug permeation across cellular barriers and drug exposure to selective cell types. *Frontiers in Pharmacology*, *9*, 1218.
- Le, T. M. D., Yoon, A.-R., Thambi, T., & Yun, C.-O. (2022). Polymeric systems for cancer immunotherapy: A review. *Frontiers in Immunology*, *13*, 812102.



- Leung, A. K. K., Tam, Y. Y. C., Chen, S., Hafez, I. M., & Cullis, P. R. (2015). Microfluidic mixing: A general method for encapsulating macromolecules in lipid nanoparticle systems. *Journal of Physical Chemistry B*, *119* (28), 8698-8706.
- León, B., & Ardavin, C. (2008). Monocyte-derived dendritic cells in innate and adaptive immunity. *Immunology and Cell Biology*, *86* (4), 320-324.
- Liu, X., Huang, N., Li, H., Jin, Q., & Ji, J. (2013). Surface and size effects on cell interaction of gold nanoparticles with both phagocytic and nonphagocytic cells. *Langmuir*, *29* (29), 9138-9148.
- Ma, W., Zhan, Y., Zhang, Y., Lin, G., & Wang, Y. (2021). The biological applications of DNA nanomaterials: Current challenges and future directions. *Signal Transduction and Targeted Therapy*, *6* (1), 351.
- Mody, V. V., Siwale, R., Singh, A., & Mody, H. R. (2010). Introduction to metallic nanoparticles. *Journal of Pharmacy and Bioallied Sciences*, *2* (4), 282-289.
- Molino, N. M., Neek, M., Tucker, J. A., Nelson, E. L., & Wang, S.-W. (2017). Display of DNA on nanoparticles for targeting antigen presenting cells. *ACS Biomaterials Science and Engineering*, *3* (3), 496-501.
- More, P. R., Karpe, A. V., Lekkala, S. P., & D'Souza, J. S. (2023). Silver nanoparticles: Bactericidal and mechanistic approach against drug-resistant pathogens. *Microorganisms*, *11* (2), 369.
- Mosser, D. M., & Edwards, J. P. (2008). Exploring the full spectrum of macrophage activation. *Nature Reviews Immunology*, *8*(12), 958-969.
- Murray, P. J., & Wynn, T. A. (2011). Obstacles and opportunities for understanding macrophage polarization. *Journal of Leukocyte Biology*, *89* (4), 557-563.
- Murray, P. J., & Wynn, T. A. (2011). Protective and pathogenic functions of macrophage subsets. *Nature Reviews Immunology*, *11* (11), 723-737.
- Nanotechnology-based drug delivery systems for the treatment of Alzheimer's disease - PMC. (2015). *National Center for Biotechnology Information*. <https://www.ncbi.nlm.nih.gov/pmc/articles/PMC4531021/>.
- Non-viral vectors for gene-based therapy | Nature Reviews Genetics. (2014). *Nature Reviews Genetics*, *15*, 541-555. <https://www.nature.com/articles/nrg3763>.
- Nsairat, H., Hrairi, H., Al-Hunaiti, A., & Awad, S. (2022). Liposomes: Structure, composition, types, and clinical applications. *Heliyon*, *8* (2), e09394.
- Pang, L., Zhu, Y., Qin, J., Feng, J., & Guo, M. (2016). Exploiting macrophages as targeted carrier to guide nanoparticles into glioma. *Oncotarget*, *7*(24), 37081-37091.
- Reinhold, H. S., & Endrich, B. (1986). Tumour microcirculation as a target for hyperthermia. *International Journal of Hyperthermia*, *2* (2), 111-137.
- Salah, A., Kebriaei, M., Manshadi, M. K. D., & Ardestani, M. S. (2021). Insights into dendritic cells in cancer immunotherapy: From bench to clinical applications. *Frontiers in Cell and Developmental Biology*, *9*, 678537.

- Salatin, S., Khosroushahi, A. Y., & Barar, J. (2015). Effect of the surface modification, size, and shape on cellular uptake of nanoparticles. *Cell Biology International*, *39*(12), 1311-1323.
- Salunkhe, S. S., Bhatia, N. M., & Bhatia, M. S. (2016). Implications of formulation design on lipid-based nanostructured carrier system for drug delivery to brain. *Drug Delivery*, *23* (4), 1306-1316.
- Selective organ targeting (SORT) nanoparticles for tissue-specific mRNA delivery and CRISPR–Cas gene editing | Nature Nanotechnology. (2020). *Nature Nanotechnology*, *15*, 335-342. <https://www.nature.com/articles/s41565-020-0669-6>.
- Shams, F., Sadeghi, A., Mahdavi, M., Hashemi, S. M., & Farid, A. (2022). Nanotechnology-based products for cancer immunotherapy. *Molecular Biology Reports*, *49* (2), 1389-1412.
- Shi, J., Xiao, Z., Kamaly, N., & Farokhzad, O. C. (2011). Self-assembled targeted nanoparticles: Evolution of technologies and bench to bedside translation. *Accounts of Chemical Research*, *44* (10), 1123-1134.
- Silver nanoparticles restrict microbial growth by promoting oxidative stress and DNA damage - PubMed. (2020). *PubMed*, *201*, 1003-1013. <https://pubmed.ncbi.nlm.nih.gov/32398973/>.
- Singh, A. (2021). Eliciting B cell immunity against infectious diseases using nanovaccines. *Nature Nanotechnology*, *16* (1), 16-24.
- Solbrig, C. M., Saucier-Sawyer, J. K., Cody, V., Saltzman, W. M., & Hanlon, D. J. (2007). Polymer nanoparticles for immunotherapy from encapsulated tumor-associated antigens and whole tumor cells. *Molecular Pharmaceutics*, *4* (1), 47-57.
- Suk, J. S., Xu, Q., Kim, N., Hanes, J., & Ensign, L. M. (2016). PEGylation as a strategy for improving nanoparticle-based drug and gene delivery. *Advanced Drug Delivery Reviews*, *99*, 28-51.
- Sukhanova, A., Bozrova, S., Sokolov, P. A., Berestovoy, M. A., Karaulov, A. V., & Nabiev, I. (2018). Dependence of nanoparticle toxicity on their physical and chemical properties. *Nanoscale Research Letters*, *13* (1), 44.
- Tang, M. X., Redemann, C. T., & Szoka, F. C. (1996). In vitro gene delivery by degraded polyamidoamine dendrimers. *Bioconjugate Chemistry*, *7* (6), 703-714.
- Wang, J., Yang, J., & Kopeček, J. (2022). Nanomedicines in B cell-targeting therapies. *Acta Biomaterialia*, *137*, 1-19.
- Wilhelm, S., Tavares, A. J., Dai, Q., Ohta, S., Audet, J., Dvorak, H. F., & Chan, W. C. W. (2016). Analysis of nanoparticle delivery to tumours. *Nature Reviews Materials*, *1*(5), 1-12.
- Wolinsky, J. B., & Grinstaff, M. W. (2008). Therapeutic and diagnostic applications of dendrimers for cancer treatment. *Advanced Drug Delivery Reviews*, *60* (9), 1037-1055.
- Worah, K., Brichacek, A. L., Murtas, D., Ghosh, S., & Tsang, M. (2016). Proteomics of human dendritic cell subsets reveals subset-specific surface markers and differential inflammasome function. *Cell Reports*, *16* (11), 2953-2966.

- Yaqoob, A. A., Parveen, T., Umar, K., & Mohamad Ibrahim, M. N. (2020). Recent advances in metal decorated nanomaterials and their various biological applications: A review. *Frontiers in Chemistry*, 8, 341.
- Yu, Z., Pan, W., Li, N., Tang, B. (2023). Smart polymeric nanoparticles in cancer immunotherapy. *Pharmaceutics*, 15 (2), 775.

# **Unraveling the Net Worth: Exploring Financial Disparities and Diversity Deficits in Tennis**

## **By Finn Johnson**

### **Abstract**

The cost of tennis for young players—such as equipment, lessons, tournaments, etc.—imposes financial barriers and affects the composition of the sport. Tennis is an expensive sport with high entry costs—competitive players require coaching, equipment wears out quickly, traveling to tournaments is both time-consuming and expensive, and tennis academies do not have financial aid but are as expensive as boarding schools. These factors, along with the fact that few professional tennis players are people of color, disproportionately affect low-income communities, especially for non-white players. In this paper, I will clarify the magnitude of the effect, how that influences the tennis circuit, and what can be done to change tennis culture.

### **Introduction**

The roar around the Arthur Ashe Stadium in Flushing, New York, was deafening. One point separated Frances Tiafoe from advancing to the US Open semifinal. Thus far, the quarterfinal between Tiafoe and Andrey Rublev had been a one-man show, with Tiafoe handily dispatching Rublev in the first two sets. After waiting for the crowd to quiet down, Tiafoe bounced the ball several times before acing Rublev outside to win the match. Tiafoe roared with the crowd and launched the second ball into the air. Tiafoe's smile proclaimed a more significant message than a win. This win was the most important of Tiafoe's young career; the twenty-four-year-old had never advanced past the quarterfinal round in a Grand Slam. His run to the semifinals—during which he beat Rafael Nadal, a twenty-two-time Grand Slam winner—was unprecedented for many reasons. Tiafoe was the youngest American man to reach the US Open semifinals since 2006 and the first African American man since Arthur Ashe in 1968 (1). Tiafoe's story is even more groundbreaking than his feats.

The story of Tiafoe's meteoric rise is a fascinating tale. His parents fled Sierra Leone to escape the burgeoning civil war and later met in Washington, D.C. Tiafoe's father worked on the construction crew for the Junior Tennis Champions Center (JTCC) in College Park (2). After construction of the JTCC was finished, Tiafoe's father became the head custodian of the building, and he converted a storage room into a living space for the family (2). Tiafoe started playing tennis at age 3 and practiced on the JTCC courts late at night and early in the morning. During one of these late-night/early-morning hitting sessions, he was spotted by Misha Kouznetsov, a JTCC tennis coach searching for talent to develop. Kouznetsov recognized his potential and helped Tiafoe compete in local tournaments (2). Tiafoe dominated prestigious junior tournaments, culminating in a win at the Orange Bowl, a prestigious junior tennis competition held annually in Florida. Winning the Orange Bowl at seventeen launched him into the spotlight; soon after, he turned pro.

Tiafoe's case is unique. Despite growing up poor, fortuitous circumstances provided him with a court to train, the opportunity to attract a renowned coach, and, ultimately, the chance to

compete at the highest level. However, most players from low-income backgrounds cannot access top coaches and courts. Instead, their journeys reflect the unforgiving side of the game. Two of the greatest female tennis players, Serena and Venus Williams, better embody the harsh realities of tennis for the poor. The sisters grew up poor and without the resources Tiafoe was provided. Their story sheds light on the plight of the thousands of other young tennis players who are disadvantaged and have to start from nothing.

With a combined total of thirty Grand Slam titles, the Williams sisters are globally recognized for their talent and inspiring rise to the top of tennis. The Williams sisters grew up poor and did not have reliable access to tennis courts, let alone coaches. Instead, their father, Richard Williams, a security guard with no tennis coaching experience, taught them to play (3). The Williams sisters grew up in Compton, with few public courts and ever fewer competitive players. Unable to afford coaching or travel to prestigious tournaments, the sisters competed locally against older competitors (3). Their remarkable rise from humble beginnings to becoming two of the greatest female athletes ever is a testament to their resilience and undying support from their families. Other Black players have experienced similar financial hardships, such as the highly ranked tour players Sloane Stephens and Taylor Townsend. While these players beat the odds and became successful tennis stars, there are thousands of non-white players with the talent to succeed but who are prevented from achieving their potential due to financial barriers. The hardships faced by Serena, Venus, Sloane, Taylor, and others are commonplace and reflective of the elitist origins of tennis.

### **Thesis Paragraph**

The most prominent junior tennis players are committed to the sport individually. Yet, numerous players attached to tennis fail to achieve their dreams due to the financial burdens. While players' circumstances remain different, the typical costs of tennis are coaching, court, and tournament fees. These factors disproportionately affect low-income communities and suggest tennis's most significant barrier is price, not talent.

### **Paper Structure**

In this paper, I will provide context for the low minority tennis player base, including the elitist origins of tennis and early discrimination. Then, I will present evidence typifying the low minority percentages today and provide information on costs such as coaching, courts, and tournaments that explain why these small numbers persist.

### **History of Tennis and Discrimination**

The modern game of tennis was invented in 1874 by Major Walter C. Wingfield, who patented the rules for the game. Games were played on smooth outdoor courts. The popularity of croquet, a lawn game where players use mallets to hit balls through hoops or wickets, meant a high supply of courts adaptable to tennis. The All-England Croquet Club held the first Wimbledon tournament in 1877. From its inception in 1868, the Club attracted wealthy members

of British society. The membership requirement was stringent, demanding exorbitant fees and affluent social connections. Croquet was a game for the rich, and the All-England Croquet Club provided a venue for the elite to socialize and compete. When tennis was introduced to the Club, it followed this pattern of exclusivity. The original Wimbledon tournaments were only attended by aristocrats and the wealthy. Only whites were permitted to participate in and play in the tournament. Even today, the Club has maintained exclusivity with hefty membership fees and a strict dress code. From its inception at its first tournament, Wimbledon, tennis has been associated with money. Indeed, tennis's history of discrimination toward non-whites emphasizes its exclusive nature.

African Americans have long faced discrimination in tennis. Because of segregation, the majority of tennis clubs excluded African Americans from membership. There were few courts or coaches in Black neighborhoods, and the cost of the sport prevented the majority of Black children from playing. The first significant development in the integration of tennis was the founding of the American Tennis Association (ATA) in 1916, the oldest African American sports association (4). The ATA created tournaments and networking opportunities for Black players. Arthur Ashe, a famous Black player with three Grand Slams, used the ATA to develop his game. However, integrating African Americans into Grand Slam tournaments was a more challenging endeavor. In the 1950s, one of the few places talented Black players could train was Dr. Robert Walter Johnson's summer camp in Lynchburg, Virginia (4). Johnson sought to break the color barrier and identified Ashe as a player who could withstand racism and become a prominent figure in the fight against discrimination. Although Jim Crow gradually faded, Johnson found it extremely difficult to desegregate a sport associated with exclusive clubs.

Johnson was obligated to receive approval for his players to participate in tournaments and to cover his players' travel and hotel expenses, as tournaments did not provide accommodations for Black players (4). Johnson taught his players to remain calm and not protest calls, as it would make them seem hostile in spectators' eyes (4). Eventually, the tide changed, and when Arthur Ashe won the U.S. Open in 1968, he ushered in the "Open Era." The Open Era admitted professional and amateur players into the Grand Slams, the four major tennis tournaments. Tennis became more lucrative—top players received prize money and scholarships. Before the Open Era, amateurs who played had to secure funding, limiting the potential for non-whites to compete. The Open Era would usher in women and non-whites into tennis. Although revenue has only increased for the top professional players, financial issues remain for young players or minorities, which is why so few play tennis.

Today, tennis's inclusivity has not increased significantly. There are more than 5,410 tennis professionals in the United States. Of those, 66.5% are white, 12.4% are Asian, 12.2% are Hispanic or Latino, and only 8.9% are Black (5). Since integration, only 3 non-white, two Black, and one Asian player have won a Grand Slam in the men's field. The women's field appears more balanced because of Serena and Venus Williams's combined 30 Grand Slams, but besides them, only four other non-white women have won a Grand Slam. Financial challenges are the primary reason for the sparse non-white tennis population. Since its origins with the British high

class, tennis has remained a sport few can afford. For the competitive junior player, tennis fees for a year of training at the high school level are around \$3,000. Access to top trainers, like those found at tennis academies, typically costs between \$50,000 to \$100,000 a year (6). Thus, only a few of the estimated 2.83 million young American tennis players will experience professional success (6).

### **Coaching Fees**

Work ethic is essential to success in tennis, but instruction is required to refine your technique and game. The player is in full view of all the spectators at a tennis match, yet their coach inspires their game. The coach is critical to each player's technique and strategy. Often, the best coaches on tour are actively pursued by the top players. The same desire for a top coach lies in junior tennis as well. Access to these coaches comes with a high cost. Individual and group tennis lessons are notorious for their exorbitant costs and financial strain on families. Thus, the benefits of coaching are available to select groups, giving them an advantage over non-trained players.

Group lessons are a popular form of instruction. Like any medium, group lessons in tennis allow players to practice without less emphasis on the individual. Group lessons are commonplace for juniors, during which they can have fun and be free from the rigor of private lessons. Group lessons are excellent at developing a junior's base level, following a structured curriculum that covers a range of fundamental skills, techniques, and strategies (6). Beginners and casual players often gravitate toward group lessons, seeking recreation and opportunities for social interaction. Group lessons are also substantially cheaper, as the cost is divided between multiple people, but they lack the individual rigor of private lessons.

The beauty of private lessons is tailored training. In an individual setting, players receive the full attention of their instructor, immediate feedback, targeted corrections, and customized guidance to accomplish specific goals and improve weaknesses (6). As a coach can devote full attention to developing one player, private lessons involve higher intensity and focus than group sessions. Therefore, these lessons enable rapid improvement and breakthroughs in a player's game. However, the advantages of private lessons come at a significant cost. For a qualified coach, private lessons start at fifty dollars an hour, equating to the cost of approximately five group sessions (6). Given the cost, many families prefer group lessons to private ones. Unfortunately, group lessons are less efficient in developing proper technique and mechanics. Hence, families who can afford private instruction substantially accelerate their child's development in tennis.

Seriously competitive junior players gravitate toward elite tennis academies. While private lessons ensure individual tennis instruction, they do not include other training elements. Private lessons rarely include fitness training or video analysis to improve other aspects of training. This is in sharp contrast to the comprehensive approach taken at tennis academies. IMG Academy, the nation's leading sports academy, has a renowned tennis department. Throughout history, they have developed 32 players who have earned a top-10 ATP ranking (a merit-based

system that determines the world's best tennis players based on tournament performance). IMG's world-class coaching and facilities provide strength and conditioning, medicine, nutrition, and visual training (7). Perhaps the most critical aspect of assisting competitive junior players is their annual training schedule. Each player works with a coach to schedule tournaments specific to their level, such as Junior Grand Slams and ITF Junior events (7). IMG Academy provides the opportunity to play at the collegiate and professional level, which many competitive junior players desire. However, these increased opportunities are expensive. IMG charges an annual tuition of 80,000 dollars and offers very little financial aid. As a result, only more affluent players can afford the price of admission, and those who can gain a competitive edge.

### **Court Fees**

Tennis lessons are an excellent way for players to learn new techniques and improve their game, but to implement these changes in matches, players need to practice on their own time. To do so, they require access to courts for multiple weekly hitting sessions. Even players without a coach can refine their game through independent practice, and many successful players were self-taught as children. For example, Andre Agassi, an eight-time Grand Slam winner, grew up hitting tennis balls on his court in the backyard, developing his skills through individual practice. Unfortunately, not every young player has access to their own outdoor court. While outdoor courts are a free option to play, their availability differs by region. In low-income areas, outdoor courts are less available. Consequently, less wealthy juniors must accept minimal playing time or pay the price for tennis club memberships offering indoor courts.

Practicing on a tennis court is a necessity for competitive junior players. States provide funding for public parks, some of which feature tennis courts. These courts are open daily and accessible to the public. For example, New York City has around five hundred outdoor courts, and Central Park is particularly popular with tennis enthusiasts (8). However, low-income areas such as the South Bronx notably lack tennis courts. Historically, the South Bronx has faced economic challenges, and recreational infrastructure does not receive the same attention as more affluent areas. Other low-income areas, such as Jamaica, Queens, and Central Harlem, face similar challenges. The limited number of tennis courts has been so prevalent that the federal government provides funding to state and local governments to support the improvement of parks and recreational facilities (9). The money is often used to build or improve tennis courts. Yet, grants do not entirely solve the problem of limited access to tennis courts.

Indoor courts are an alternative to outdoor courts. Indoor courts are often well maintained and of a higher quality, but memberships are required to access these courts. Tennis clubs are deeply ingrained in tennis culture, frequently where affluent players practice and take lessons. The pricey reputation of tennis partly derives from exorbitant club fees. In the tennis hub of Portland, Oregon, there are many clubs with different services and features, all of which charge a high price. For example, Irvington Tennis Club has around 400 spots in a community of almost 30,000, forcing people to sit on its waitlist for years. The club requires a \$3,000 initiation fee and two \$2,000 monthly payments for dues. Further, they charge six dollars per hour to play on the



indoor courts. The Irvington Club's high fees and court time costs are standard for tennis clubs nationwide. Due to the facilities these private institutions manage, revenue has to be steady and come from multiple sources. The courts, coaches, and people tennis clubs expose you to are vital. However, the many costs of being a tennis club member deter many from joining.

### **Tournament Fees**

For a competitive junior, court time is geared toward honing their skills, hoping to earn college scholarships and play professionally one day. Coaches and scouts determine a player's future potential by observing their match play. Specifically, they analyze match play from tournaments widely available for all skill levels. However, tournaments are expensive and require entry and travel fees for competing players. Local tennis tournaments are generally cheap and accessible. The UTR (Universal Tennis Rating) circuit has gained prominence recently as a way for tennis clubs to host tournaments and for juniors to compete. Any tennis club can host an event and allow non-members to participate. Fees range from only tens of dollars for a tournament. Due to the popularity of UTR, coaches, and recruiters can infer a player's UTR rating. While UTR requires five matches to give a rating, it only counts matches in the last twelve months. Therefore, playing a steady stream of tournaments is necessary to maintain your rating, and competing in many tournaments can still be expensive.

While the UTR circuit has the benefit of accessibility, there are more prominent tournaments for competitive juniors. Players like Roger Federer, Rafael Nadal, and Novak Djokovic began their careers by winning the Junior Grand Slams. Many other players compete in the Junior Grand Slam or ITF Junior Tour, two of the most competitive junior tournaments. These tournaments are international circuits that allow the best juniors to play worldwide and experience international competition to prepare them for their professional careers. In addition to requiring players to have a certain skill level, these tournaments impose other constraints. Due to the global footprint of these tournaments, travel fees are required. Similar to professional Grand Slam tournaments, these fees can be insurmountable for most aspiring tennis players. While air travel is expensive, there are also food and hotel costs. Less fortunate families cannot pay for these high travel costs and do not play in these tournaments.

### **Conclusion**

Tennis has a justified reputation as an exclusive sport with little support for minority players. In the beginning, racism and discrimination in tennis discouraged minority participation. Today, minority barriers have shifted to high coaching costs, tournament costs, and unequal access to facilities. Expenses for junior tennis players range in the thousands of dollars, making it a very exclusive playing field. Relatively few minority players have overcome these barriers to entry, resulting in disproportionately few professional minority players. As a result, tennis has developed the stigma that it mainly caters to the rich and white. To help recruit more young, talented minority players, the USTA and other tennis federations need to find ways to lower the barriers to entry, such as coaching and equipment so that money is not a deterrent. Further,

governments must spend more on low-income neighborhoods with little tennis access. Finally, high-quality tournaments must reach low-income areas, ensuring disadvantaged players can compete at the highest level. By achieving a more diverse player base, the sport will find new success, where price is not a constraint for players.

## Works Cited

- Barrabi, Thomas. "Coco Gauff, other youth tennis players face expensive path to the pros." FOX Business, Aug. 2019.  
<https://www.foxbusiness.com/features/us-open-coco-gauff-youth-tennis-training-cost>. Accessed 6 June 2024.
- "Before the Open Era: African Americans in Tennis during the 50s and 60s." UCLA, Oral History Project.  
<https://arthurashe.ucla.edu/2021/03/11/before-the-open-era-african-americans-in-tennis-during-the-50s-and-60s/>. Accessed 6 June 2024.
- Bembry, Jerry. "Frances Tiafoe: The story behind tennis' unlikely hero." Landscape, June 2019.  
<https://andscape.com/features/im-looking-for-the-next-frances-tiafoe-the-story-behind-tennis-unlikely-hero/>. Accessed 6 June 2024.
- "Community Development Block Grant." HUD Exchange.  
<https://www.hudexchange.info/programs/cdbg/>. Accessed 6 June 2024.
- Cottom, Tressie. "Venus and Serena Williams on Their Own Terms." Bazaar, Feb. 2022.  
<https://www.harpersbazaar.com/culture/features/a38957619/0001-0179-origin-story-marc-h-2022/>. Accessed 6 June 2024.
- "IMG Academy Boys Tennis Program." IMG Academy.  
<https://www.imgacademy.com/boarding-school/tennis>. Accessed 6 June 2024.
- Shaftel, David. "The Courts of New York City." The New York Times, Aug. 2018.  
<https://www.nytimes.com/2018/08/23/nyregion/tennis-courts-new-york-city.html>. Accessed 6 June 2024.
- Scott, Jelani. "Sports World Reacts to Francis Tiafoe's U.S. Open Win Over Nadal." Sports Illustrated, Sep. 2022.  
<https://www.si.com/tennis/2022/09/06/sports-world-reacts-frances-tiafoe-u-s-open-win-over-rafael-nadal>. Accessed 6 June 2024.
- "Tennis Professional Demographics And Statistics In The US." Zippia.  
<https://www.zippia.com/tennis-professional-jobs/demographics/>. Accessed 6 June 2024.

# **The Fear of Learning: The Interplay between Adrenaline and Neuroplasticity By Victor Zheng**

## **Author Bio**

Victor Zheng is an 11th-grade student studying at St. George's School in Vancouver, Canada. Having involved himself in a variety of disciplines, from music and debate to business and mathematics, Victor decided to focus his efforts on pursuing the fascinating field of neuroscience. Intrigued by the uniquely interdisciplinary nature of the subject as well as its potential to unravel the mystery of the human mind through rigorous scientific study, Victor sought out the opportunity to research this topic. In the future, Victor hopes he can leverage his well-rounded skill set and develop expertise in cognitive science to help other individuals lead more fulfilling lives. Outside of his academic pursuits, Victor enjoys recreating his favorite songs in GarageBand, breaking a sweat on the rowing machine, and beating his personal record in the game "15 Puzzle".

## **Abstract**

This study delves into the intricate relationship between high-stress, non-traumatic scenarios, such as athletics, and the neurotransmitters released to prepare the body for action. This release is triggered by signals from between adrenaline and neuroplasticity, and the paper aims to provide a comprehensive understanding of the underlying mechanisms and effects. The research questions center on how adrenaline affects the brain's limbic system, which detects potential threats in the environment. Once released, adrenaline affects a range of physiological processes, including increased heart rate, blood pressure, and glucose metabolism. Neuroplasticity refers to the brain's ability to change and adapt its structure and function triggers neuroplastic processes, including synaptic plasticity, neuroregeneration, and emotion regulation. Through this literature review, it is evident that adrenaline responds to experiences and environmental stimuli. It is the foundation of learning, memory formation, and recovery from brain injuries. These are the molecular and biological mechanisms that, as key neurotransmitters, play a significant role in neuroplasticity. This review highlights that the impact of adrenaline on intracellular signal transduction underlying neuroplasticity is complex and involves intracellular signaling pathways, gene expression, and structural changes in neural circuits.

The relationship between adrenaline and gene expression thereby regulates neural plasticity. Furthermore, the involvement of adrenaline in the regulation of learning and memory, as well as in drug addiction, shows that neuroplasticity is bidirectional, with each influencing the other in a dynamic fashion. Adrenaline affects neuroplasticity by binding to receptors on neurons, initiating a cascade of intracellular events. This binding triggers signaling cascades that modulate gene expression and alter the function of neural circuits.

**Key Words:** Neuroplasticity, Adrenaline, PTSD, Fear Processing, Fear Conditioning, Emotional Regulation, Stress, Learning

## **1. Introduction**

In today's fast-paced society, the concept of neuroplasticity, or the brain's ability to change and adapt in response to experience, has gained increasing attention. Neuroplasticity is crucial for learning and memory formation. However, the mechanisms underlying neuroplasticity remain complex and multifaceted. One molecule that has been extensively studied in this context is adrenaline, a hormone and neurotransmitter that plays a critical role in numerous physiological processes (Arnstein, 1997; Cureton, 1956; Van Zijderveld et al., 1993). Additionally, adrenaline has been shown to regulate emotion. Adrenaline modulates the activity of neural circuits involved in processing emotional information and regulating appropriate behavioral responses. In times of stress or anxiety, adrenaline can enhance our ability to focus attention and filter out irrelevant thoughts (Van Zijderveld et al., 1993).

## **2. The Adrenaline System and Its Role in Stress: the Neurobiological Interplay**

The human body is an intricate network of interconnected systems that work together to maintain homeostasis and ensure survival (Sapolsky, 1996). Among these systems, the adrenaline system stands out as a crucial player in the body's response to stress. Its intricate relationship with the limbic system, particularly in the context of chronic stress and hormonal changes, sheds light on the neurobiological mechanisms underlying the body's adaptation to stressful environments (McEwen, 2007).

The limbic system, often referred to as the emotional brain, is responsible for a wide range of functions, including emotional processing, memory formation, and hormonal secretion. It comprises several structures, such as the amygdala, hippocampus, and hypothalamus, which work together to regulate the body's response to stress (Sapolsky, 1996). When faced with a perceived threat, the limbic system activates the sympathetic nervous system, leading to the release of adrenaline from the adrenal glands.

Adrenaline, also known as epinephrine, is a hormone that plays a pivotal role in the body's fight-or-flight response. It prepares the body to respond to immediate threats by increasing heart rate, dilating pupils, and redirecting blood flow to essential muscles (Arnstein, 1997; Van Zijderveld et al., 1993). However, the release of adrenaline is not always appropriate, and its inappropriate activation can lead to a range of physical and psychological consequences (McEwen, 2007).

One such consequence is the alteration of the limbic system's structure and function in response to chronic stress or changes in hormone levels. This neuroplasticity, or the brain's ability to change in response to experience, can lead to modifications in how the brain perceives threats and triggers adrenaline release. For instance, prolonged exposure to stress can lead to an increase in the number of adrenaline receptors in the brain, making it more sensitive to adrenaline and more likely to respond with a fight-or-flight reaction even in non-threatening situations (Arnstein, 1997).

Moreover, chronic stress can also affect the hypothalamus-pituitary-adrenal (HPA) axis, which regulates the body's stress response. Prolonged activation of the HPA axis can lead to a

dysregulation in cortisol levels, a hormone closely related to adrenaline. This dysregulation can further exacerbate the body's stress response, leading to a vicious cycle of increasing adrenaline release and altered limbic system function (McEwen, 2007).

The implications of this neurobiological interplay between the adrenaline system and the limbic system are far-reaching. It not only affects how individuals perceive and respond to stress but also has implications for mental health disorders characterized by altered stress responses, such as anxiety and depression. Understanding the mechanisms underlying this interplay could lead to the development of more effective treatments for these disorders (Arnstein, 1997; Cureton, 1956; Van Zijderveld et al., 1993).

In conclusion, the adrenaline system and its role in stress are intricately linked to the limbic system and its neuroplasticity. The interaction between these systems sheds light on the body's adaptation to stressful environments and has implications for understanding and treating mental health disorders characterized by altered stress responses. Future research in this area could lead to a deeper understanding of the neurobiological underpinnings of stress and its consequences for human health and well-being.

### **3. The Interplay Between the Adrenaline System and Neuroplasticity: Implications for Anxiety Disorders and PTSD**

The adrenaline system, a crucial component of the body's stress response mechanism, plays a pivotal role in situations demanding urgent action. This hormone, secreted by the adrenal glands, is released in response to various stimuli, ranging from psychological stressors to physical exercise, and prepares the body to cope with potential threats by triggering a cascade of physiological changes. The present literature review aims to explore the intricate relationship between the adrenaline system and neuroplasticity, with a particular focus on its relevance to anxiety disorders and post-traumatic stress disorder (PTSD) (Kleim & Jones, 2008).

When confronted with stressful situations, such as fleeing from predators or engaging in competitive sports, the body's stress response mechanism is activated, leading to the release of adrenaline. This hormone acts on various target tissues, including the brain, heart, lungs, and muscles, to mobilize the body's resources and facilitate a rapid and effective response to the challenge. In the brain, adrenaline influences neuronal excitability, synaptic transmission, and the activity of various neurotransmitter systems, thereby modulating cognitive, emotional, and behavioral responses to stress (McEwen, 2007).

Neuroplasticity, the brain's ability to change and adapt in response to experience, plays a critical role in the development and maintenance of anxiety disorders and PTSD. These conditions are characterized by deregulated adrenaline levels and disrupted neural circuits that modulate fear and anxiety responses. Chronic stress and traumatic events can lead to maladaptive changes in the brain, including altered synaptic connectivity, neuronal atrophy, and abnormalities in neurotransmitter systems, which contribute to the persistence of fear and anxiety symptoms (Sapolsky, 1996).

The interplay between adrenaline and neuroplasticity is particularly relevant in understanding the etiology of anxiety disorders and PTSD. Adrenaline release, triggered by psychological stressors or traumatic events, can exacerbate existing neural vulnerabilities and contribute to the development of these conditions. Conversely, chronic anxiety and stress can lead to alterations in the adrenaline system, resulting in deregulated hormone levels and abnormal stress responses (Cureton, 1956). This bidirectional relationship between adrenaline and neuroplasticity highlights the complex nature of anxiety disorders and PTSD and the need for a comprehensive approach to treatment (Van Zijderveld et al., 1993).

By understanding how adrenaline affects neuroplasticity, we can gain insights into the development of novel therapeutic strategies for anxiety disorders and PTSD. Current treatment options, including pharmacotherapy and psychotherapy, often target symptoms rather than the underlying neurobiological mechanisms. However, by exploring the role of adrenaline in neuroplasticity, we may identify new targets for intervention that address the root causes of these debilitating conditions (Kleim & Jones, 2008). For instance, drugs that modulate adrenaline release or activity may hold promise for the treatment of anxiety disorders and PTSD by normalizing hormone levels and restoring neural circuit function.

In conclusion, this literature review has highlighted the intricate role of adrenaline in neuroplasticity and its relevance to anxiety disorders and PTSD. Future research should focus on elucidating the precise mechanisms underlying this relationship and exploring its therapeutic implications (Cureton, 1956). By taking a comprehensive and integrated approach to understanding the neurobiological basis of anxiety disorders and PTSD, we can pave the way for the development of more effective and targeted treatments that improve patient outcomes and enhance overall quality of life.

#### **4. The Role of Adrenaline in Neuroplasticity**

Neuroplasticity has long been a subject of intense scientific scrutiny. Among the various neurochemicals that modulate this complex phenomenon, adrenaline stands out as a key player, particularly in the context of stress-related disorders (Arnstein, 1997; Cureton, 1956). This section aims to delve deeper into the intricate relationship between adrenaline and neuroplasticity, highlighting its potential implications for our understanding of post-traumatic stress disorder (PTSD) and other stress-related conditions.

Adrenaline, also known as epinephrine, is a hormone and neurotransmitter that plays a pivotal role in the body's response to stress (Sapolsky, 1996). It is released from the adrenal glands during acute stress and acts on various body systems, including the brain, to mobilize resources and prepare the organism for a "fight or flight" response (Arnstein, 1997; Van Zijderveld et al., 1993). In the brain, adrenaline binds to adrenergic receptors, triggering a cascade of biochemical events that ultimately lead to changes in neural circuits and behavior.

One of the most striking effects of adrenaline on neuroplasticity is its ability to modulate fear processing and extinction learning. Fear processing refers to the brain's ability to detect and respond to threatening stimuli, while extinction learning involves the suppression of fear

responses through repeated exposure to the stimulus in the absence of an aversive outcome (Kleim & Jones, 2008). Both processes are crucial for adaptive behavior and are often disrupted in individuals with PTSD.

Adrenaline has been shown to enhance fear processing by increasing the excitability of neurons in the amygdala, a brain region that plays a central role in emotional processing and memory formation. This heightened excitability can lead to the formation of stronger fear memories, which may contribute to the persistence of fear responses in PTSD. Conversely, adrenaline can also facilitate extinction learning by promoting synaptic plasticity in the prefrontal cortex, a region involved in executive function and decision-making (Van Zijderveld et al., 1993). This dual role of adrenaline underscores its complex influence on neuroplasticity and its potential implications for the treatment of stress-related disorders.

Understanding the molecular mechanisms through which adrenaline modulates neuroplasticity is crucial for developing targeted therapies for PTSD and other stress-related conditions. One promising avenue of research involves the use of adrenergic receptor agonists or antagonists to modulate the effects of adrenaline on the brain (Arnstein, 1997). By selectively targeting specific adrenergic receptors, it may be possible to enhance fear extinction while minimizing the formation of fear memories, thereby alleviating symptoms in individuals with PTSD.

In conclusion, the relationship between adrenaline and neuroplasticity is a complex and multifaceted one, with significant implications for our understanding of stress-related disorders. By elucidating the mechanisms through which adrenaline modulates fear processing and extinction learning, researchers can pave the way for novel therapeutic approaches that address the root causes of PTSD and other conditions. As our understanding of this intricate interplay continues to evolve, it holds the promise of transforming the way we diagnose and treat stress-related disorders, ultimately improving the lives of millions of affected individuals.

## **5. The Impact of Adrenaline on Emotion Regulation and Learning**

In the intricate web of neurobiological processes, adrenaline also stands out as a key player in the regulation of emotions and learning (Cureton, 1956). This hormone, secreted by the adrenal glands in response to stress or excitement, has profound effects on the body's physiological and psychological states. Its influence extends beyond the mere 'fight-or-flight' response, encompassing complex mechanisms that shape our cognitive and emotional landscapes.

One of the most notable aspects of adrenaline's function is its role in fear conditioning and extinction learning. Fear conditioning is a process whereby an individual learns to associate a neutral stimulus with an aversive outcome, such as pain or danger (McEwen, 2007). This associative learning is critical for survival, as it enables rapid and appropriate responses to potential threats. Adrenaline has been shown to modulate this process, enhancing the consolidation of fear memories in the brain.



Conversely, extinction learning refers to the acquisition of new information that modifies or inhibits fear responses. It is essential for adaptive coping, as it allows individuals to reevaluate threats and adjust their behavior accordingly. Adrenaline also plays a part in this process, although its effects are more nuanced (Arnstein, 1997). While moderate levels of adrenaline can facilitate extinction learning, excessive amounts can impair it, leading to persistent fear responses and anxiety-related disorders.

Furthermore, adrenaline release during a stressful event can facilitate the encoding of contextual information into long-term memory (Van Zijderveld et al., 1993). This is because adrenaline activates the amygdala and hippocampus, brain regions involved in emotional processing and memory formation, respectively. By enhancing the salience of emotional stimuli, adrenaline promotes the formation of vivid and enduring memories. These memories can later be retrieved to inform adaptive behavior in similar situations, enabling individuals to respond effectively to recurring challenges.

However, the effects of adrenaline on learning and emotion regulation are not always beneficial. Excessive or inappropriate adrenaline release can lead to maladaptive learning and anxiety-related behaviors (McEwen, 2007). For instance, chronic stress, which is often characterized by elevated adrenaline levels, can impair cognitive functions such as attention and memory. It can also disrupt the balance between fear conditioning and extinction learning, resulting in the persistence of fearful responses even in the absence of actual threats.

Moreover, individual differences in adrenaline sensitivity and reactivity can influence the way people respond to stressful events and learn from them (Kleim & Jones, 2008). Some individuals may be more susceptible to the negative effects of adrenaline, while others may be more resilient. These differences may partly explain why some people are more prone to developing anxiety disorders or post-traumatic stress disorder (PTSD) following traumatic experiences.

In conclusion, adrenaline plays a crucial role in emotion regulation and learning processes. While it can enhance memory formation and facilitate adaptive coping in response to stressful events, it can also lead to maladaptive outcomes if released excessively or inappropriately. Understanding the complex interplay between adrenaline and these processes is essential for developing effective treatments for anxiety-related disorders and optimizing learning outcomes in educational and therapeutic settings (Arnstein, 1997; Cureton, 1956).

## **6. Conclusion**

The complex interplay between adrenaline and neuroplasticity remains an active area of research with implications for various fields, including psychiatry, psychology, and education. A better understanding of the mechanisms underlying adrenaline's effects on neural plasticity will not only enhance our understanding of how the brain adapts to stress but also identify novel targets for treating stress-related disorders such as PTSD. Moreover, this knowledge may also inform strategies to optimize learning and performance in educational and professional settings.

As we continue to unravel the intricate web of neural plasticity, the role of adrenaline emerges as a critical factor in shaping our responses to the challenges we face in a rapidly changing world.

Fig. 1. Schematic representation of the behavioral protocols, experimental design, treatments and samples collection. (A) Fear acquisition. (B) Fear conditioning (FC) procedure. i.a., immediately after; HPLC, high performance liquid chromatography; qPCR, real-time polymerase chain reaction.

### A Fear acquisition

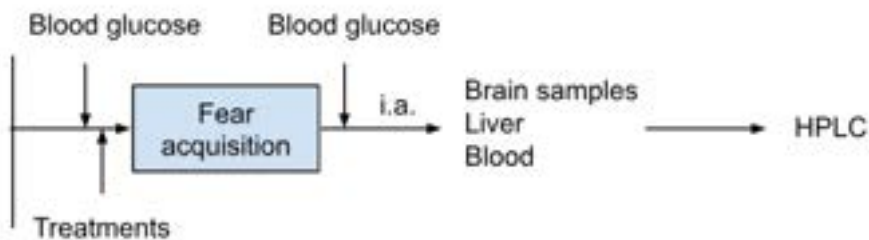

### B Fear conditioning

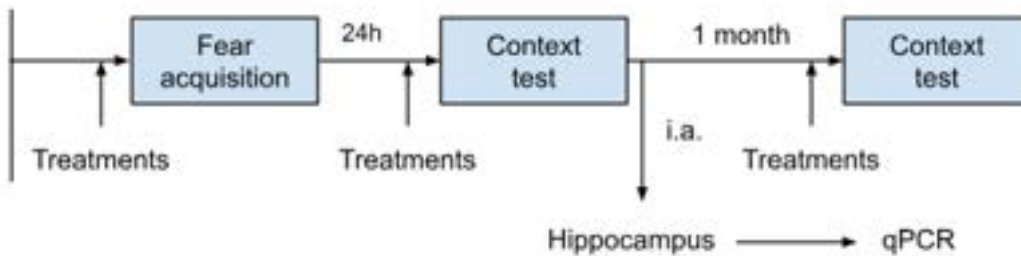

Note: From “Epinephrine Released During Traumatic Events May Strengthen Contextual Fear Memory Through Increased Hippocampus mRNA Expression of Nr4a Transcription Factors,” by Oliveira A, Martinho R, Serrão P, Moreira-Rodrigues M., in *Frontiers in Molecular Neuroscience*, 2018

Fig. 2. Mean state anxiety scores of a low and high neurosomatic groups at baseline, placebo, during and after adrenaline infusion

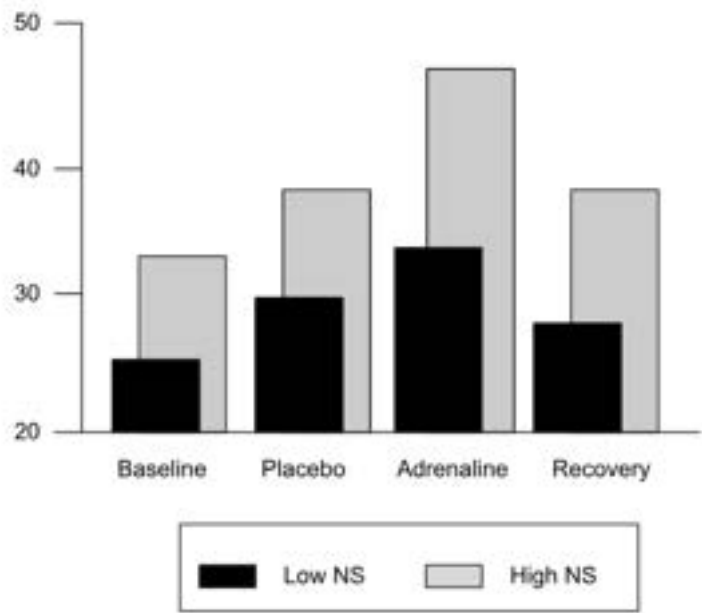

Note: From “Adrenaline and the relationship between neurosomatism, aerobic fitness and mental task performance,” by Van Zijderveld, G. A., van Doornen, L. J. P., van Faassen, I., Orlebeke, J. F., van Dyck, R., & Tilders, in *Biological Psychology* 36 (p. 167), 1993

Fig. 3. Changes in blood pressure and heart rate in female students with different academic performance goals

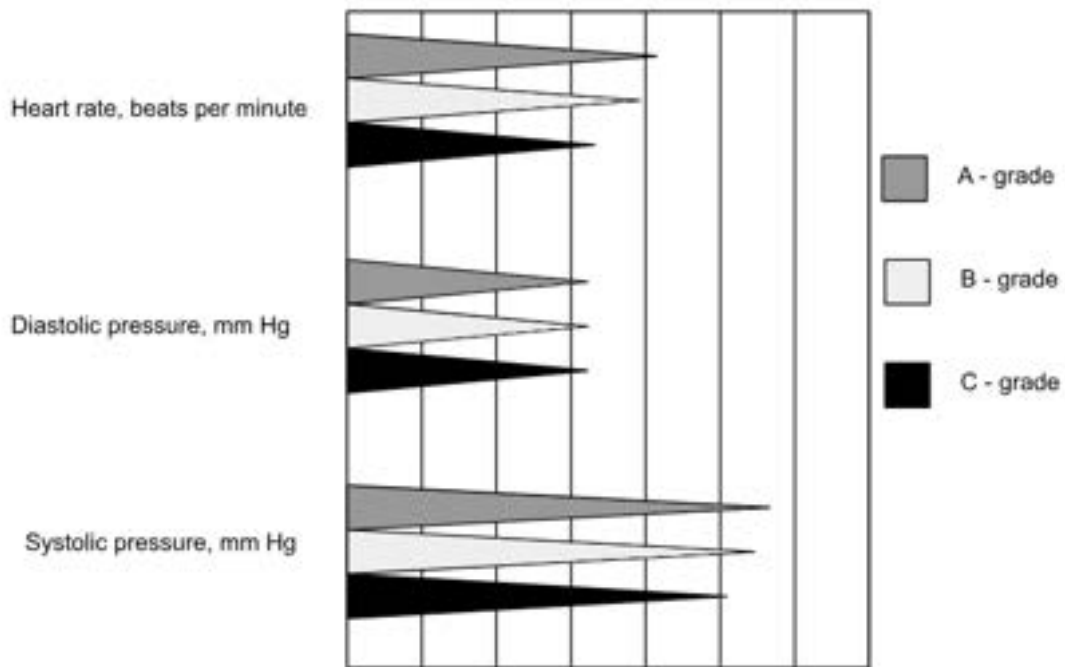

Note: From “Functional state of the cardiovascular system in female students with different academic performance grades,” by Vaha, A. A., Svetlana, V. M., in *Cardiometry; Moscow* Iss. 17 (p. 105), 2020

**Acknowledgement**

Special thanks to Dr. Robert Clark for taking me under his wing and providing invaluable feedback throughout our time together.

### Works Cited

- Arnstein, P. M. (1997). The neuroplastic phenomenon: A physiologic link between chronic pain and learning. *Journal of Neuroscience Nursing*, 29\*(3), 179-186.  
<https://doi.org/10.1097/01376517-199706000-00005>
- Cureton, T. K. (1956). Relationship of physical fitness to athletic performance and sports. *JAMA*, 162\*(12), 1139–1149. <https://doi.org/10.1001/jama.1956.02970290035010>
- Fuchs, E., & Flügge, G. (2014). Adult neuroplasticity: More than 40 years of research. *Neural Plasticity*, 2014\*, Article ID 541870, 10 pages. <https://doi.org/10.1155/2014/541870>
- Oliveira, A., Martinho, R., Serrão, P., & Moreira-Rodrigues, M. (2018). Epinephrine released during traumatic events may strengthen contextual fear memory through increased hippocampus mRNA expression of Nr4a transcription factors. *Frontiers in Molecular Neuroscience*, 11\*. <https://doi.org/10.3389/fnmol.2018.00334>
- Rudland, J. R., Golding, C., & Wilkinson, T. J. (2020). The stress paradox: How stress can be good for learning. *Medical Education*, 54\*, 40-45. <https://doi.org/10.1111/medu.13830>
- Vaha, A. A., & Svetlana, V. M. (2020). Functional state of the cardiovascular system in female students with different academic performance grades. *Cardiometry; Moscow*, 17\*, 101-106.  
<http://www.cardiometry.net/issues/no17-november-2020/cardiovascular-system-of-students>
- Van Zijderveld, G. A., van Doornen, L. J. P., van Faassen, I., Orlebeke, J. F., van Dyck, R., & Tilders, F. J. H. (1993). Adrenaline and the relationship between neurosomatism, aerobic fitness and mental task performance. *Biological Psychology*, 36\*(3), 157-181.  
[https://doi.org/10.1016/0301-0511\(93\)90016-2](https://doi.org/10.1016/0301-0511(93)90016-2)

# **An Evaluation of Artificial Intelligence's Impact on the Workplace and Economy by Melanie Cheung**

## **Abstract**

In recent years, the world faced rapid changes and disruptions caused by emerging technologies such as Artificial Intelligence (AI) and robotics taking over tasks previously performed by humans. The ability and potential of such technologies indicate economic growth through productivity gains, whilst holding the downside of job disruption. This report sets out to investigate the research question of 'To what extent does Artificial Intelligence impact future economic growth and job markets?' Artificial Intelligence can boost efficiency, decrease costs, and increase output. By facilitating quicker and more precise operations, AI holds the potential to increase corporate competitiveness greatly. The productivity gains from AI could result in stronger GDP growth and greater national wealth for the economy as a whole. On the other hand, their exceptional abilities pose the risk of existing jobs being threatened, especially when technology nowadays is able to perform certain occupations more efficiently, accurately, and for cheaper costs. This situation has evoked fear, which was further exacerbated when Goldman Sachs predicted 300 million international full-time jobs to be impacted by the appearance of AI (AI Systems). This report will examine the economic and employment impacts resulting from Artificial Intelligence. Through reviewing past studies as well as predictions of the future, the hypothesis that Artificial Intelligence can significantly boost long-term economic growth, despite leading to more jobs being vulnerable to disruption simultaneously is formed. To investigate this matter, this report will look into productivity, efficiency, and GDP growth caused by AI, shedding light on their impact on economic growth. Furthermore, the structure of the labor market will be studied in order to estimate the number and types of jobs susceptible to transformation and automation, as well as those that have already gone through the effects of AI. Finally, the report will suggest policies and strategies to maximize the benefits of AI while mitigating any possible threats. This includes governmental and corporate reforms that can be implemented for smoother transitions during this period of technological change.

## **Introduction**

Artificial Intelligence (AI) has taken the world by storm since the launch of ChatGPT in November 2022, generating lots of interest and attention from all across the globe. AI has undeniably accelerated the development of society, proving our technology to be as advanced as ever. Humans process information and data significantly slower than AI, which can solve fifty mathematical problems in the time it takes for humans to answer one (Artificial Intelligence).

A particular area of interest in AI is generative artificial intelligence, which refers to a type of artificial intelligence that uses complex algorithms and deep learning to produce various types of works, such as text, imagery, audio, and synthetic data (What Is). In a study conducted by researchers from Stanford University and the Massachusetts Institute of Technology, it was found that a group of people with AI-trained generative AI tools were 14% more productive than

a group without, showing how AI can aid us in the workplace (Stanford and). Additionally, a report by Bloomberg in 2022 stated that investors poured in USD \$2.6 billion in 110 generative AI-focused startups in the US alone in that year (Investors Are). Something to note is that ChatGPT and generative AI only started gaining more attention towards the end of 2022 generative AI, demonstrating how generative AI was able to secure so much funding in a short amount of time. According to a Rockefeller Insight report, the global AI market is estimated to reach USD \$900 billion in value by 2026, growing at a CAGR of about 19% currently (Top 10). Generative AI in particular has the potential to generate USD \$2.6 to \$4.4 trillion in value across multiple industries (Economic Potential).

While AI's effectiveness and accuracy allow humans to benefit from faster project completion and decreased labor costs, it also puts many occupations at risk because machines are better equipped to perform certain tasks, with Goldman Sachs predicting 300 million international full-time jobs to be impacted by the appearance of AI (AI Systems). In 2023, International Business Machines Corporation announced its plan to stop hiring for 7,800 jobs that can be done by AI (IBM Will). Unlike previous AI automation which mainly affects jobs with low skills, generative AI will impact knowledge workers the most. Moreover, the quality of AI work is not always guaranteed, with a survey from Deloitte stating that 91% of AI projects failing to meet expectations of the Chinese manufacturers they surveyed (Deloitte Survey). And since AI is constantly learning and evolving, the systems could pick up biases in our world, conveying users misinformation.

Seeing the rise of Artificial Intelligence in the past few years and its ability to shape the world and our future, the research question of 'To what extent does Artificial Intelligence impact future economic growth and job markets?' will be answered through this research paper. This paper sets out to investigate the economic impact of Artificial Intelligence by examining past studies on their findings regarding AI performance in businesses and the workplace. This paper also looks into the aspect of entrepreneurship, making use of qualitative data from interviews with entrepreneurs and their opinion on how AI has impacted their entrepreneurial endeavors. Through the many methods of data collection, this report hopes to provide a holistic view of the impacts AI has on the economy. At the end of the report, the topic of ethics and governance behind AI will be discussed, with some examples of regulations being brought up as potential solutions.

## **1.1.Hypothesis**

As an attempt to answer my research question, I have formulated the hypothesis of how Artificial Intelligence is currently reforming the economic and labor market to a large extent, both in a positive and negative way. As an example, AI is an amazing tool for automating repetitive tasks which can save the time of workers and companies, allowing for a heavier focus on creative tasks that humans better excel at. As a downside of this advantage, since monotonous duties no longer have to be performed by humans, there is a decrease in demand for workers, leading to job losses in certain occupations and industries. However, my hypothesis is that

despite there being both advantages and disadvantages to the economic impact of Artificial Intelligence, the benefits outweigh the drawbacks. Looking at the current development of AI, it is undoubtedly going to continue advancing and the economy will have to continuously adapt to technological changes. These changes may generate more job opportunities for the public, and overall improve the quality of our lives, leading to my hypothesis of AI being beneficial to humanity in the long term.

## **2.Literature Review**

Given the rapid development of Artificial Intelligence in the past few years, there is much that we are still navigating through in this new technological era. Because of this, there are not many resources available for public access in regard to the economic impact of AI, which means I have limited databases to work with for data collection. Therefore, this report contains a heavier focus on conclusions drawn from existing research. Through reviewing past literature and research, I will be looking into multiple aspects of Artificial Intelligence to form a holistic understanding of this topic.

### **2.1.Background**

Diving deeper into Artificial Intelligence, it is a branch of computer science that can stimulate cognitive processes similar to those of humans, such as learning, reasoning, perception, and problem-solving (What Is). Based on ability, AI can be put into three categories: Artificial Narrow Intelligence (ANI), Artificial General Intelligence (AGI), and Artificial Super Intelligence (ASI) (The Three). ANI is the only type that currently exists, having limited abilities, and primarily focusing on one singular task. One of the examples of ANI includes generative AI. AGI, on the other hand, remains a concept as of now. If it were to be developed, which some people remain concerned about, it would have a human-like mind and thinking. Lastly, there is ASI, which is AI technology that would have exceptional abilities and knowledge, surpassing humankind. This AI would be able to develop its own beliefs and even experience emotions, as shown in science fiction films (What Are). However, at the current stage of technological development, it is unlikely for us to reach this type of AI in the near future. And hopefully, by then, there will be more regulations on the usage of AI.



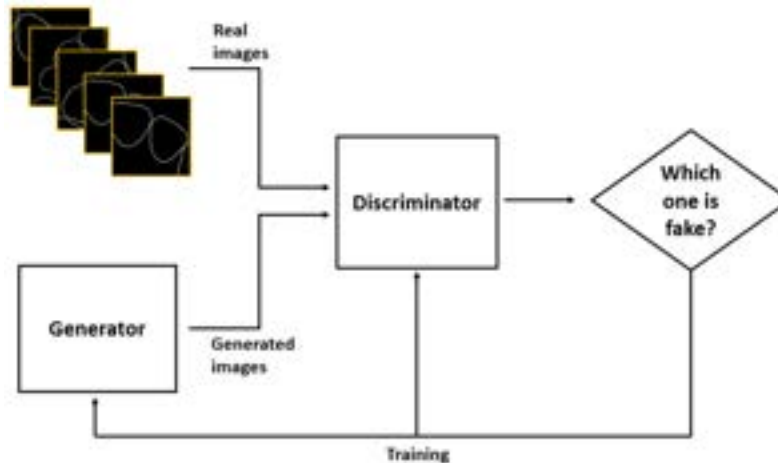

Figure 1. Generative Adversarial Network Deep-learning Model (Kim 3)

To understand Artificial Intelligence better, we can take a look at the Generative Adversarial Network (GAN), which is a deep-learning model that explains the functioning of generative AI. The GAN model is a great tool for producing realistic content like images, videos, and text (A Gentle). As seen in Figure 1, the model contains two neural networks: the generator and the discriminator. Using this generator, we can use varying inputs to generate content like images or text. It is able to do this by producing data that the discriminator network classifies as ‘Real’. As for the discriminator, it is responsible for recognizing real or fake data by being trained on datasets of real examples and others produced by the generator network. In adversarial training, which is when the generator and discriminator are trained together, the generator generates realistic data to trick the discriminator, while the discriminator tries to distinguish whether the data is real or fake. This training loops until the generator is able to create data that cannot be told apart from real data by the discriminator (Generative Adversarial).

## 2.2. Historical Context

Since ChatGPT’s introduction to the world in November 2022, Artificial Intelligence has been a heated topic of discussion. However, AI has actually been with us for decades. The history of AI can be described through three phases (What Is). The first phase (the 1950s to 1970s) marks the beginning of early AI technologies such as expert and rule-based systems, which were used to perform tasks like medical diagnoses or financial analyses, and were seen as tools to increase productivity and efficiency. The first piece of work related to AI was published in 1950 by Alan Turing, titled “Computer Machinery and Intelligence” which proposed The Imitation Game, a test for computer intelligence (Turing Test). Two years later, computer scientist, Arthur Samuel, developed a checkers-playing program, which is the first in history to learn the game independently, marking the beginning of Artificial Intelligence (Samuel’s Checkers). In 1966, Joseph Weizenbaum produced the ELIZA, a mock psychotherapist, which is also the first ‘chatterbot’ (now commonly known as ‘chatbot’). This chatbot used natural language processing (NLP) to talk to humans (A Brief). In five years’ time, James L. Adams

created The Stanford Cart, an autonomous vehicle. Soon, it was able to navigate a room full of chairs without human interference successfully (Stanford Cart).

In the second phase (around the 1980s), researchers started exploring machine-learning algorithms. To enable machines to learn from experience and improve performance, algorithms such as neural networks and decision trees were designed. The development of NLP and computer vision technologies was especially significant in this era, and these tools are now used in our daily lives such as speech recognition and image analysis (What Is). During that period of time, AI was gaining worldwide attention, with the Japanese government allocating \$850 million, worth \$2 billion in today's money, to the Fifth Generation Computer project in 1981 (Pollack). The project's aim was to produce computers that could translate, communicate in human language, and express human-like reasoning and made huge contributions to the development of this phase.

The third phase of AI research began in the early 21st century and concentrated on computing power and datasets. In this phase, there was huge progress in the development of deep-learning algorithms, which process vast amounts of data and recognize patterns too difficult for humans to detect. As a result, there have been advances in the field such as autonomous driving, robotics, and natural language processing (Soori et al.). In 2011, Apple launched Siri, the first digital assistant with the ability of voice recognition (From Siri).

The economic impact of AI has existed throughout history. In the first phase of AI, expert systems and rule-based systems were a way for industries to increase their productivity and efficiency. Despite not being incredibly advanced AI technologies, they were still able to automate routine and repetitive tasks, letting the human workforce focus on more complex and creative tasks. No matter in the past or currently, technological advances have oftentimes led to substantial shifts in the labor market. In the 20th century, the rise of automation in the manufacturing sector caused major job losses (A Short). In the 1970s, industrial robots were brought into the scene of the manufacturing industry, leading to considerable productivity improvements (Robots in). Within eleven years, over 10,000 of these robots were used across the globe. According to the International Federation of Robotics, investments in such robots reached 16.5 billion USD, with 422,000 units sold (Industrial Robots). This demonstrates how AI developments in the past have built a foundation for our current technological advancements, and are able to cause improvements in productivity, efficiency, and cost savings across industries.

### **2.3.Current AI Performance**

Compared to the capabilities of Artificial Intelligence decades ago, it has come a long way to its current stage. In 2016, a humanoid robot called Sophia was created by Hanson Robotics, which was the first robot with a realistic human-like face fostering the ability to perceive and replicate emotions (Sophia). Meanwhile, OpenAI, which was founded in 2015, started working on other AI-related technologies. In 2020, they started beta testing GPT-3, which uses Deep-learning to create language and writing tasks almost distinguishable from those produced by humans. One year later, OpenAI also developed DALL-E, a generative AI

technology that processes and understands text prompts to generate AI images (Introducing ChatGPT). Today, AI can be found in almost every industry, automating a large variety of tasks, leading to increased productivity and efficiency, as well as lower costs for businesses.

In September 2022, a female AI robot was made the CEO of a Chinese online gaming company named Fujian NetDragon Websoft (The Replacement). For her job, she signs documents, approves proposals, and makes decisions on behalf of the company, enabling a risk-free system. Since she is a robot, she does not receive a salary for her work, which means the company saves up in terms of costs while being able to draw in more profit. While this situation has not yet been made common, we can expect to see more of these cases from now on. Furthermore, reinforcement learning, which is a type of feedback-based machine learning, contains the potential for AI to get exponentially better at learning and making decisions without the need for human intervention (Exploring the Future). With our evolving technologies, it is no doubt that our future will shine brightly technologically.

## **2.4.Economic Impact**

With our newfound technologies, the economic impact of Artificial Intelligence has also become more profound. From a report by PricewaterhouseCoopers International Limited, AI is predicted to contribute up to \$15.7 trillion to the global economy by 2030, with \$6.6 trillion of this coming from increased productivity, and the rest coming from others such as the development of new products and increased demand (PwC's Global). On top of this, Accenture found that AI technology has the potential to double the annual economic growth rate in 12 developed countries by 2035 (Artificial Intelligence). By 2030, our global GDP could increase up to 14% under the impact of AI, with sectors such as manufacturing and healthcare being benefited the most (Why Do).

Artificial intelligence has revolutionized various industries. For instance, healthcare is being heavily impacted by the benefits AI has to offer. Given the accuracy and efficiency of AI, algorithms can be used to analyze medical images and identify different diseases for early treatment, potentially saving lives. AI can also use its analytical ability to process vast amounts of data and recognize medical patterns in order to improve patient care, whilst reducing costs since AI can replace manpower or allow workers to focus on more important tasks AI cannot complete. The various advantages AI brings to the medical field have not just enhanced medical care but also increased the economic value of this industry. In 2018, the global healthcare market was valued at \$2.1 billion. With the help of AI, it is now expected to grow to \$36.1 billion by 2025, which equates to a compound annual growth rate of 50.2% (The AI in Healthcare). Another industry AI has a huge influence on is the financial services industry. AI algorithms can identify users' preferences and provide more targeted products and services. Moreover, AI has the capability of providing customers with 24/7 support, which is something that may be difficult for a fully human workforce to achieve. AI bots can deal with customer inquiries efficiently, freeing human service agents to focus on complex issues, leading to higher customer satisfaction. The adoption of AI in the financial industry is estimated to lead to cost savings of up to \$1

trillion by 2030, and it may generate \$300 billion in revenue for varying financial institutions by 2030 (What's the Real).

On the other hand, it may be argued that AI has negative impacts on the economy as well. The development and maintenance of AI are extremely costly, meaning that bigger companies with higher budgets have an advantage over smaller ones in terms of the adoption of such technologies, further exacerbating economic inequality. The gap between a few large firms and the rest could also enlarge, contributing to existing income and wealth disparities, and leaving behind those with fewer resources at the back of the trend. Furthermore, one of the main concerns people remain to have regarding AI is bias. AI systems are trained based on systems and if the system were biased, the AI could spread misinformation and cause chaos. A recent study found that some algorithms were more likely to choose men over women when hiring, indicating how biased AI systems could lead to discrimination and unfairness in the economic system and aggravate inequality (Bias in Algorithms).

## **2.5. Job Market Impact**

The impact of Artificial Intelligence extends beyond the economy and into the workplace, both positively and negatively. Given the efficiency and accuracy of AI technology, it is undeniable that some jobs may be automated or even replaced by AI. By 2025, automation is predicted to displace 16% of jobs in America. According to McKinsey Global Institute, up to 14% of the global workforce, which is 375 million workers, may have to change occupations and learn new skills because of automation by 2030 (Jobs Lost). AI's ability to perform repetitive tasks for lower costs than hiring lots of workers has caused displacements in industries such as manufacturing, retail, and financial services (The History). While businesses may be able to save costs by using robots instead hiring workers, this could lead to increasing unemployment rates and intensified income inequality. For example, Foxconn Technology Group, the supplier of Apple and Samsung, replaced 60,000 factory workers with robots, and many experts have expressed their prediction of more companies following suit (Wakefield).

At the same time, AI presents opportunities and advantages to the workplace. According to the World Economic Forum, AI is expected to create 133 million new jobs and automate 75 million, which translates to 58 million jobs as a net increase (The Impact). A survey found that 65% of primary school students today will grow up having professions that do not yet exist (65 Percent). These statistics demonstrate the job opportunities that AI can bring to us, and how its advantages in the labor market can outweigh the disadvantages. Technology is everchanging, and global workforces and businesses have to work hand in hand to continually improve and stay on top of the trends.

Moreover, instead of replacing jobs, AI can assist human workers in being more efficient and accurate. For instance, Entrepreneur magazine developed an AI-driven platform that enables their workers to collaborate better using AI, directly improving their quality of work (3 Ways). The magazine has reflected on the usage of their platform, and they believe the benefits it brings may lead to more companies developing platforms like such. Additionally, family robots have

been created for the past few years, for example, Jibo, which gathered \$25 million in funding (Jibo, the Personal). This robot could act as your personal assistant, organizing your schedule and reminding you of events, all through inputs such as speech, touch, and vision. While this robot is mainly used at home currently, it would not be surprising for one to be developed specifically for the workplace in the near future. Having a personal working assistant would enable people to work smarter and focus on creative and complex tasks while leaving the repetitive ones to AI, resulting in higher productivity.

According to a survey, 37% of businesses making use of AI reported an increase in productivity and reduced costs (AI Adoption). It is estimated that by 2035, AI could lead to a higher labor productivity rate, up to 40%, which adds \$14 trillion to the global economy (The Economic). This demonstrates the many advantages of bringing AI into the workplace, and how it would benefit the greater economy and community in general. Not to mention, Fujian NetDragon Websoft, a Chinese online gaming company made headlines when it announced its CEO as Ms. Tang Yu, a robot powered by AI (A Video). This is a real-life example of how AI replacing workers could help companies make better decisions due to better and quicker analytics while keeping the costs of hiring employees low. Of course, this poses the risk of people losing their jobs on a global scale because of how AI can overpower a human worker in many ways. However, looking on the bright side, this translates to a demand for other occupations needing workers, and the benefits AI can bring to the workplace may be seen in the long term.

### 3. Financial Modeling

A financial model can analyze and predict outcomes by being a qualitative representation of financial situations, aiding people in making good decisions in investing, forecasting, and such (What Is Financial). There are different variables that make up a financial model, such as revenue, interest rates, and market trends, which affect the  $y$  value that we are trying to find. Among the many types of financial models, there is the multiple linear regression model, which I am using to explain the relationship between Artificial Intelligence and its impact on the economy. The financial equation of a multiple linear regression model is as follows:

$$y = \beta_0 + \beta_1 x_1 + \beta_2 x_2 + \dots + \beta_n x_n + \varepsilon \quad (1)$$

In this equation, the  $y$  value stands for the dependent variable, the number we are trying to calculate by plugging in numbers for the independent variables on the right-hand side. The variables  $x_1, x_2, x_n$  are independent variables, which will change depending on which variables the user chooses (The Multiple). The aim of using the multiple linear regression model is to estimate the coefficients for the predicted  $y$  value and the independent variable's values. This equation can be used for understanding the relationship between different financial values and factors that may influence financial outcomes.

In this case, my multiple linear regression model aims to find out how different variables combined affect the yearly profit of companies. I hypothesize that the investment put into Information Technology (IT) infrastructure and the number of employees in a company would greatly affect yearly profit. This is because as you have more manpower to increase productivity, more profit will also be made. However, I wanted to further investigate IT infrastructure's role in profit gain in a company and see whether it would have a more drastic effect than the labor force. To achieve this, I have identified the key variables in this financial model.

The dependent variable ( $y$ ), also the number we are trying to calculate using this equation, is the yearly profit yielded by the companies I am looking into. This will be inputted in HKD billions in the data table.

There are two independent variables in this model, with the first being the investment put into Information Technology Infrastructure yearly in HKD billions ( $x_1$ ), and the second one being the number of employees ( $x_2$ ). After plugging the variables in, the model would look like this.

$$\text{Yearly Profit} = \beta_0 + \beta_1 \times \text{Investment} + \beta_2 \times \text{Employee} + \varepsilon \quad (2)$$

As an example to test my model, I chose Bank of China and HSBC to collect data on ("Annual Report"). Below are the datasets of the two banks from 2019 to 2022 ("Financial Review").

<b>Bank of China</b>			
Year	Profit (in HKD Billions)	Investment into IT Infrastructure (in HKD Billions)	Number of Employees
2019	220.28	12.71	309,384
2020	223.78	18.22	309,084
2021	248.05	20.31	306,322
2022	259.14	23.5	306,182

Table 1. Data from Bank of China

HSBC			
Year	Profit (in HKD Billions)	Investment into IT Infrastructure (in HKD Billions)	Number of Employees
2019	136.433	2.802	235,351
2020	90.196	2.9	226,059
2021	86.563	7.719	226,059
2022	97.611	7.459	219,199

Table 2. Data from HSBC

Using the datasets from Table 1 and 2, I plotted the numbers in R Studio, which allows for data analysis and making predictions based on data, forming a code for my financial model shown below.

```

1 #First create the data set
2 data <- data.frame (
3   Year = c(2019,2020, 2021, 2022),
4   Profit_Yearly = c(220.280, 223.780, 248.050, 259.140, 136.433, 90.196, 86.563, 97.611),
5   Investment_IT = c(12.71, 18.22, 20.31, 23.5, 2.802, 2.900, 7.719, 7.459),
6   Employee_Count = c(309384, 309084, 306322, 306182, 235351, 226059, 226059, 219199)
7 )
8
9 model <- lm(Profit_Yearly ~ Investment_IT + Employee_Count , data = data)
10 summary (model)
11

```

Figure 2. The R Code for my financial model with data plugged in

After running the code, the multiple linear regression model was provided with the exact coefficients, as demonstrated here.

$$Yearly Profit = 40.242722 + 6.126366 \times Investment + 0.000038 \times Employee + \varepsilon \quad (3)$$

The coefficients of the equation come from the 'lm' function shown in Figure 2, which estimates the coefficients for the intercept and independent variables. To briefly summarize the mathematical methods R code uses to achieve the best-fit line for this mode, the calculations mainly put in are through matrix algebra and optimization (Estimating the Coefficients).

40.242722 ( $\beta_0$ ) is the value of the dependent variable (yearly profit) when the independent variables (investment in IT infrastructure and employee count) are zero.

6. 126366 is the coefficient of investment in IT infrastructure, and it shows how much the dependent variable (yearly profit) is expected to shift after the independent variable increases one unit while holding the other variable constant. So that means the yearly profit increases approximately 6. 126366 when there is a one unit increase in the investment in IT infrastructure while the number of employees stays constant.

0. 000038 is obtained from a similar logic as the previous coefficient, but it describes the other variables in the equation. In this case, it means that the yearly profit increases by 0. 000038 when there's a one-unit increase in employee count while investment in IT infrastructure stays constant.

### 3.1. Model Accuracy Assessment

Bank of China					
Datapoint	Year	Profit (in HKD Billions)	Investment into IT Infrastructure (in HKD Billions)	Number of Employees	Error Term ( $\epsilon$ )
1	2019	220.28	12.71	309,384	-7.988
2	2020	223.78	18.22	309,084	-15.437
3	2021	248.05	20.31	306,322	8.225
4	2022	259.14	23.5	306,182	12.931
HSBC					
5	2019	136.433	2.802	235,351	27.658
6	2020	90.196	2.9	226,059	-6.345
7	2021	86.563	7.719	226,059	-19.904
8	2022	97.611	7.459	219,199	0.861

Table 3. Error terms of the dataset

The code on R Code wasn't able to provide me with the error term ( $\epsilon$ ) of the financial model, which is calculated by finding the difference between the predicted value of the dependent variable and the actual regression values. Since there are eight data points from my dataset (four from the Bank of China and four from HSBC), there are eight error terms. After calculating the error terms for each equation, I formed them into the table pasted above in Table



3. To explain the error terms, I will use the first data point from the Bank of China in 2019 as an example. For this datapoint, the error term was -7.988 which means the predicted yearly profit value was 7.988 units lower than the actual observed value, and we can also plug this error term back into the financial model, forming this equation.

$$\text{Yearly Profit} = 40.242722 + 6.126366 \times 12.71 + 0.000038 \times 309,384 - 7.988 \quad (4)$$

Using these error terms, I can identify which predicted values are significantly off from the observed value. Some of the more significant points in this dataset would be the fifth datapoint where the predicted yearly profit was 27.658 higher than the actual number, which is something to take into account when applying the financial model for calculations. Other than that, the model seems relatively accurate, but I decided to look for other ways to validate its accuracy.

To further look into the accuracy of the model, I was able to obtain the R-squared and the Residual Standard Error (RSE) value by adding a code on R Code. The R-squared value is a measure of how well the independent variables (investment in IT infrastructure and employee count) explain the dependent variable's (yearly profit) variations (Residuals and Diagnostics). It is a value between 0 and 1, whereas higher values generally indicate that the model is able to capture the data accurately. In this case, my R-squared value was 0.9556, which means around 95.56% of the variability in the dependent variable can be explained by the multiple linear relationship with the independent variables, proving the model to be relatively accurate.

The RSE measures the average magnitude of the residuals of the model and quantifies how widely or unevenly the observed data points are distributed around the regression line. The lower the RSE value, the closer the predicted values are to the actual values (RSE vs R<sup>2</sup>). The RSE value of my model is 18.65, meaning that the observed values deviate from the predicted values by approximately 18.65 units on average, so the model deviates a reasonable amount.

On top of this, the code generated four graphs which are commonly used to validate the reliability of a financial model. The graphs will be explained below.

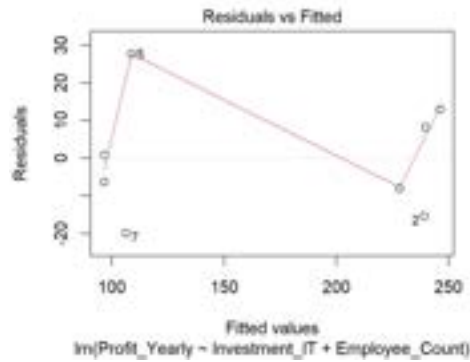

Figure 3. Residuals vs. Fitted plot

The R Code generated the ‘Residuals vs Fitted’ used in regression analyses to assess a linear regression model and allows people to understand the relationship between the fitted values and corresponding residuals. In this graph, the decrease in residuals while the fitted values increase indicates that the predictions made by the model are relatively accurate (Residuals Vs. Fits). For example, when the fitted value is around 100, the residual is 0, meaning that the predicted value is very close to the observed value. However, this graph does show flaws in the model, such as the last point of the graph where the fitted value is around 245 and the residual is around 12, meaning that the model’s predictions are deviating from the observed results. Even though the model is mostly able to capture the predictions accurately, there are areas where it couldn’t fully demonstrate the relationship between the different variables in this model.

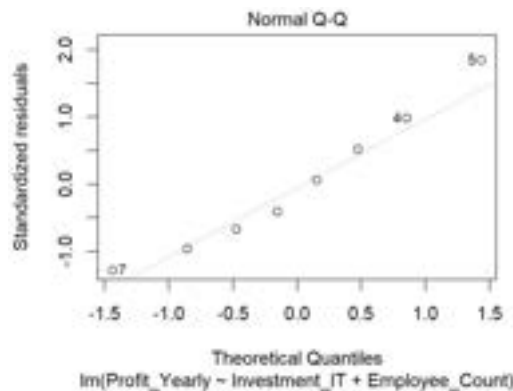

Figure 4. ‘Quantile-Quantile’ (Q-Q) plot

The second graph generated by R code is the ‘Quantile-Quantile’ (Q-Q) plot, which assesses a model to see if its data came from theoretical distribution and follows a normal distribution. If the data is normally distributed, the points on the Q-Q plot will lie on a straight diagonal line (How to Use). As shown in the graph, most points of the graph stay on or close to the line of best fit, meaning that most of the data does follow a normal distribution. However, there are outliers in this dataset, as seen in the last two points, but they only fall out of the line of best fit slightly, so it does not pose a huge problem with the distribution.

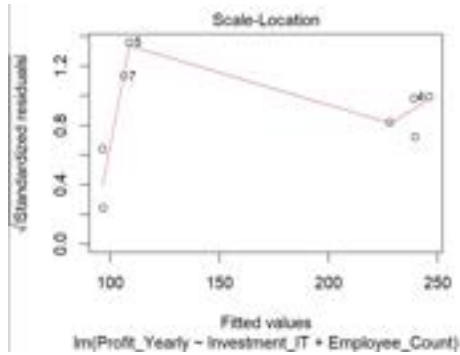

Figure 5. Scale-location graph

R Code also generated the scale-location graph, a diagnostic plot assessing the heteroscedasticity assumption in a regression model. The square root of the absolute value of the standardized residuals is plotted against the fitted values, and the standardized residuals are also divided by their estimated standard deviation to make them more comparable on a scale. Because the aim of this graph is to identify patterns or variability of the residuals, it is ideal to see a scatter of points with no clear relationship, indicating constant variance (How to Interpret). Looking closely at this graph, we can see there is no clear trend between the different data points, which signifies the data is variant. There is no ‘cone’ shape which hints at heteroscedasticity, which is the unequal scatter of residuals or error terms, showing the reliability of the data.

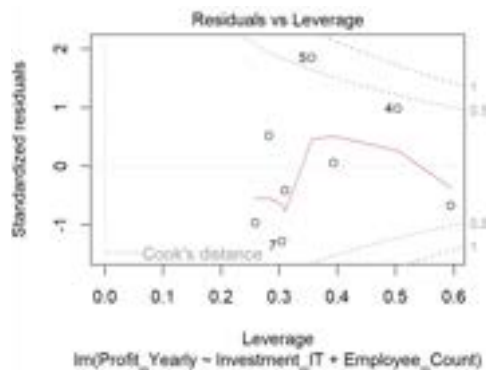

Figure 6. Residuals vs. leverage plot

The last plot generated by R Code is the Residuals vs. leverage plot, which spots influential data points in a model and assesses the impact of individual data points on the model's coefficients and predictions. Within this plot, there is the Cook's distance, which measures the influence of each data point on the regression conflicts (Linear Regression). Datapoints that have higher leverage and higher residuals usually have a greater influence on the model's results, and points outside of the dotted line of Cook's distance have a strong influence as well, which means deleting those points from the dataset would change the model heavily. In this graph, there is no datapoint outside the dotted line, which means no significant outliers, so there is no need to further investigate any point to determine their impact on the model.

### **3.2. Discussions**

The purpose of creating this multiple linear regression model was to better understand the factors that affect the profit companies draw in. In this case, these factors were the investment amount a company puts into Information Technology Infrastructure and the number of employees in a company. By creating a financial model and feeding data from the Bank of China and HSBC, I was able to take a look into the coefficients and gain insight into the individual impact of each independent variable on the yearly profit of the two banks.

First, I was able to obtain the intercept term from R Code, which was 40.242722. This is the expected value of yearly profit when both investment in IT infrastructure and the employee count is zero, so we may think of this value as a baseline profit that can be gained under the absence of the independent variables.

Then, we can take a look at the coefficients of the equation, which allow us to understand their individual impact on the yearly profit of the two banks. As explained previously, the coefficient value is how much the yearly profit will increase when that independent variable goes through a one-unit increase, while holding the other independent variable constant. The coefficient of the investment in IT infrastructure is 6.126366 while it is 0.000038 for the number of employees, which means the former has a stronger positive impact on the yearly profit yielded by the bank in comparison to the latter, having a 6.126328 difference.

In practical terms, this means that it may be more beneficial and profitable for certain companies to invest more in technology than hiring more employees. This financial model allows us to understand that the presence of AI has definitely changed the structure of many companies, with many putting more money and effort into developing better technologies instead of growing manpower as a method to earn more. Despite the findings of this model being discouraging for some workers since this means companies may soon start seeing the effect of investing in technologies over hiring workers and start dismissing workers, we could also see this as an opportunity. Workers could familiarize themselves with the technologies companies are interested in further developing, so companies may find them a valuable asset to the company, which can help lead the workforce to having a more positive impact than the investment in IT infrastructure on a company's profit gains.

## **4. Qualitative Research**

Apart from focusing on the financial and economic side of Artificial Intelligence, I was also interested in gathering research on the qualitative side of AI, such as how people playing different roles in society have opinions on it. Therefore, I reached out to people in various industries and areas of specialties and conducted interviews with them.

### **4.1. Words from an Entrepreneur**

To gain a deeper understanding of Artificial Intelligence's role in entrepreneurship, I reached out to a local entrepreneur, Mr. Jason Cheung, who generously accepted my interview request. From observing the lack of practical English learning resources on the market, Mr.

Cheung founded QualiFly, an AI-based English learning platform that personalizes exercises to maximize students' potential. According to studies, the global AI in the education market is expected to grow at a compound annual growth rate of 41.14% (Artificial Intelligence), and Mr. Cheung is sure to have grasped this opportunity. QualiFly has been utilizing AI for a while, from using it to analyze students' English performance and recognize patterns to generating exercises to target specific weaknesses of a student.

Upon being asked about Artificial Intelligence and its impact, Mr. Cheung states his optimism regarding the future development of such technologies. Seeing the incredible ability of AI, he finds it to be a major opportunity for his company, and plans on further employing it. As a current project, QualiFly has been navigating through the capabilities of Generative AI and considering how to make use of it to enhance its platform.

When it comes to AI's impact on entrepreneurship and businesses in general, Mr. Cheung believes that traditional companies are likely to gradually get automated or even replaced, especially those that don't keep up with the ever-changing technological trends. On the other hand, startups based on technology can heavily benefit from AI since it can reduce the workload on programmers' sides, and even lower different occupation entry barriers since there is less of a need for knowledge-based work after AI's appearance in the labor force. For instance, since QualiFly functions partially based on AI, the more technology advances, the more their services can improve, so the future of the company is bright. While many companies are faced with panic and uncertainty, Mr. Cheung believes that there are no threats to QualiFly at this stage, and AI should be utilized in businesses. As of this moment, QualiFly's competitive edge remains, as AI will not be able to replace them in the near future.

#### **4.2. Expert Insights**

In an attempt to strengthen my understanding of Artificial Intelligence from an expert's perspective, I discussed the implications of AI with Professor XiXin Wu. Professor Wu is a professor in the Department of Systems Engineering and Engineering Management at the Chinese University of Hong Kong, currently working on how AI processes speech and language data. As someone who investigates the development of AI, he believes the benefits of AI can outweigh the disadvantages. On the positive side, AI is a powerful tool, assisting us in our daily chores and in the workplace. When AI systems are being used wisely, the economic industry and progress can greatly improve. As an example, a startup in Silicon Valley introduced voice-altering technology so the accents of call center workers can be reduced (The AI Startup). While some countries are known for the hiring of workers being cheap, those workers may have accents that make customers hard to understand. This technology can ensure the costs put into labor stay low while maintaining a high service quality, saving money, and boosting efficiency. On the other hand, AI, just like many other things, has flaws as well. If humans fail to acknowledge the urgency of equipping themselves with AI-related knowledge, it is likely that many lose their jobs to machines. Professor Wu also brought up the phenomenon of 'hallucination', which refers to generative AI's tendency of fabricating information (Why

Companies). The impact of hallucination is disastrous, as it can cause panic among users that find AI to be incredibly reliable. Despite this, Professor Wu believes that with the right control and education on AI, its positive impact can be overpowering. AI will continue to advance in the future, and as humans, we should adapt to its capabilities and learn how to maximize its services, such as learning how to come up with the most effective prompts, and how to incorporate AI into our work. As a professional in Artificial Intelligence, Professor Wu believes there are policies and regulations needed to be implemented to better protect users of AI, and potential issues of AI should be made clear to the public in this technological era.

After speaking with Professor Wu, I discussed the future of Artificial Intelligence with Professor Edmond Yeung, a professor in the Department of Management and Marketing at Hong Kong Polytechnic University. He too sees the potential of AI and believes that as AI advances, the skills needed to thrive in this era are changing as well. Before AI became so developed, many prioritized gaining knowledge, and traditional areas of expertise. However, since AI can easily take care of tasks at rates far beyond humans, our priorities now have to change. Professor Yeung believes in the importance of acquiring the right presentation and research skills, which will aid us in working more efficiently with AI, raising productivity. Of course, creativity and innovation are two things humans can outperform AI at, and Professor Yeung urges us to take advantage of this. To make sure we don't get replaced by machines and AI in the future, we must be able to foster unique skillsets and visions that can assist us in being more proficient in this ever-changing world.

## **5. Conclusion**

### **5.1. AI Ethics, Governance, and Regulations**

As Artificial Intelligence rapidly advances, the potential harms AI could bring to humanity are emerging. As previously mentioned, AI is subject to bias, which could happen if the AI were to be trained on biased systems. When this happens, it could lead to unfair outcomes as well as intensified discrimination among humanity. As an example, facial recognition software used to be unable to recognize the faces of Black people. This has put Black people at a disadvantage in hiring and housing, because of AI applications' anti-Black biases (AI Automated). Instead of allowing humans to connect better, AI could stir problems in society by worsening the discrimination against people who have been oppressed for a long time in history.

On top of this, AI poses the threat of breaches of privacy and data security becoming more commonplace. Most of us make use of AI systems on a daily basis, and these systems rely on data, storage, and analysis, including handling users' personal data. For example, virtual personal assistants such as Siri from Apple and Alexa from Amazon process users' voice recordings and user preferences to better personalize customer experiences (Are Alexa). Also, AI systems in healthcare gather personal patient data to provide accurate analyses of patients' health conditions (Davenport and Kalakota). While these services are beneficial for us and can certainly make our lives easier, breaches of privacy could happen if people's personal information is not handled carefully. In 2013, Yahoo was hacked, and personal information from three billion users

was stolen, including users' names, email addresses, passwords, and phone numbers (Perlroth). While Yahoo is not an AI-based company, this data breach highlights the severity of insecurity in personal data collection, urging us to think about the current policies keeping AI systems in place.

Lastly, AI is undoubtedly going to affect the labor market and cause job displacement, threatening the lives of workers worldwide. Since many of AI's working capabilities far exceed human workforces, many occupations, especially in industries such as manufacturing, financial services, and customer services, could be automated or replaced by machines. Despite this, more job opportunities are simultaneously being created by AI. However, many fail to take advantage of this since these new occupations require skills with technology, which they are unfamiliar with. The impact of this could result in a greater unemployment rate, which has to urgently be addressed.

As a response to the potential harms of AI, many countries have promptly taken action to ensure AI systems are being kept under control. As a way to inform the public on the ethical implications of AI, the Institute of Electrical and Electronics Engineers published the 'Ethically Aligned Design', which is a report describing methods to ethically make use of AI and protect yourself from potential dangers (A Vision). In terms of the protection of personal data, the European Union introduced the General Data Protection Regulation (GDPR) in 2018, which regulates how organizations use people's personal data to protect their privacy (EU General). However, this does not necessarily cover the full scope of AI risks, so the EU soon launched The Artificial Intelligence Act (The European). Being the first comprehensive law posed regarding AI, it covers three main aspects. First, applications that cause an unacceptable risk are banned. Second, legal requirements are implemented upon high-risk applications. Third, applications not labeled as high-risk or unacceptably risky are left unregulated. The transparency offered by The AI Act is beneficial for people to keep updated on how their data is being used, and whether or not it is being exploited. To enforce this policy, the Act is monitored by governments across Europe, displaying the fact that the multiple countries are regulating each other, allowing for safer use of AI systems. Additionally, China recently published a set of rules governing the usage of generative AI which are due to take effect on August 15, 2023. One of the rules includes generative AI providers being required to stop illegal activities when they are performed using their platforms, and the providers have to set strict restrictions to ensure Chinese minors do not get addicted to AI platforms (China Sets).

I believe that monitoring and setting guidelines for the usage of Artificial Intelligence is crucial and should be implemented in countries across the world. However, something that does not attract enough attention is the need for AI-related education. Careers across the globe are about to disappear from the appearance of AI, and many may fail to jump to a job created by AI immediately due to their inexperience with technology. As a result, employment rates could drop rapidly, directly affecting the labor market. To solve this, programs regarding AI should be provided to the general public by the government or non-profit organizations, especially to those at risk of being jobless. These programs could educate people on how to effectively make use of

AI, so they will be able to find a new job and make a living even if their current one gets automated. Seeing the future of AI, such AI-based education should exist in schools as well. Students across the globe should be required to take up AI courses to better equip themselves for their future occupations and make sure they will be able to stay on top of market trends. Hopefully, after the implementation of various policies, as well as more education on AI, we will be able to maximize the benefits AI can bring us whilst minimizing its potential harm.

## **5.2. Summary of Findings**

Based on the literature review and data I have collected, it can be deduced that the impact Artificial Intelligence has on the economy and labor market is extremely profound, both in a positive and negative way, yet it is heading toward a brighter future.

AI holds great potential to improve our economy, boosting productivity and allowing companies to gain more profit through more efficient work. Workers no longer need to go through repetitive tasks and can spend their time and effort on more creative and complex tasks, which could seriously help businesses in certain industries. However, at the same time, this means companies may replace their workforce with AI since they can reduce costs from hiring while increasing profit from having AI work efficiently and accurately. Despite this, the appearance of AI is predicted to generate millions of jobs worldwide, so as long as people become incentivized to learn how to work alongside AI, there are still many opportunities available.

From the multiple linear regression model I came up with to demonstrate the impact investment in Information Technology Infrastructure and employee count have on a company's yearly profit, I was able to find out that investment in IT infrastructure has a much stronger influence on a company's yearly profit than the number of employees. This further proves my point stating that AI and other technologies are capable of replacing humans at our jobs, and even excelling at them. While it is undeniable there will be other threats brought by AI, there are many opportunities present that could outweigh the harms of AI, and humanity is still well on its journey to discovering the hidden capabilities and full potential of AI.

Implementing regulations is strongly encouraged for us to thrive in this new technological era. From monitoring and setting policies on how to treat privacy breaches and organization's usage of customers' personal data to promoting AI-targeted education, governance must be carried out to ensure the public's safety and to control the future of AI. Through methods like such, we will be able to make the most out of the benefits coming from AI while mitigating the harm it can bring. Technology, especially AI, is and will continue to be a crucial part of our world, so instead of fearing it, we should learn to embrace it and incorporate it into our daily lives. It is only then can we fully capitalize on AI's productivity and potential.



## Works Cited

*AI Adoption in Marketing: Current Stats and Trends.*

[www.digitalsmiles.tv/aiadoptioninmarketing3acurrentstatsandtrends](http://www.digitalsmiles.tv/aiadoptioninmarketing3acurrentstatsandtrends). Accessed 14 Aug. 2023.

*AI Automated Discrimination. Here's How to Spot It.*

[www.vox.com/technology/23738987/racism-ai-automated-bias-discrimination-algorithm](http://www.vox.com/technology/23738987/racism-ai-automated-bias-discrimination-algorithm). Accessed 7 Aug. 2023.

*The AI in Healthcare Market Is Expected to Grow from USD 2.1 Billion in 2018 to USD 36.1 Billion by 2025, at a CAGR of 50.2%.*

[www.prnewswire.com/news-releases/the-ai-in-healthcare-market-is-expected-to-grow-from-usd-2-1-billion-in-2018-to-usd-36-1-billion-by-2025--at-a-cagr-of-50-2-300770738.html](http://www.prnewswire.com/news-releases/the-ai-in-healthcare-market-is-expected-to-grow-from-usd-2-1-billion-in-2018-to-usd-36-1-billion-by-2025--at-a-cagr-of-50-2-300770738.html). Accessed 14 Aug. 2023.

*The AI Startup Erasing Call Center Worker Accents: Is It Fighting Bias – or Perpetuating It?*

[www.theguardian.com/technology/2022/aug/23/voice-accent-technology-call-center-white-american](http://www.theguardian.com/technology/2022/aug/23/voice-accent-technology-call-center-white-american). Accessed 14 Aug. 2023.

*AI Systems like ChatGPT Could Impact 300 Million Full-time Jobs Worldwide, with Administrative and Legal Roles Some of the Most at Risk, Goldman Sachs Report Says.*

[www.businessinsider.com/generative-ai-chatpvt-300-million-full-time-jobs-goldman-sachs-2023-3](http://www.businessinsider.com/generative-ai-chatpvt-300-million-full-time-jobs-goldman-sachs-2023-3). Accessed 19 July 2023.

"Annual Report - 2019-2022." *BOCHK Financial Reports*,

[www.bochk.com/en/aboutus/ir/finreport.2020.1.html](http://www.bochk.com/en/aboutus/ir/finreport.2020.1.html). Accessed 14 Aug. 2023.

*Are Alexa and Siri Considered AI?* [bernardmarr.com/are-alex-and-siri-considered-ai/](http://bernardmarr.com/are-alex-and-siri-considered-ai/). Accessed 14 Aug. 2023.

*Artificial Intelligence (AI) Market in the Education Sector by End-user, Learning Method and Geography-Forecast and Analysis 2023-2027.* Technavio,

[www.technavio.com/report/artificial-intelligence-market-in-the-education-sector-industry-analysis](http://www.technavio.com/report/artificial-intelligence-market-in-the-education-sector-industry-analysis). Accessed 5 Aug. 2023.

*Artificial Intelligence Poised to Double Annual Economic Growth Rate in 12 Developed Economies and Boost Labor Productivity by up to 40 Percent by 2035.*

[newsroom.accenture.com/news/artificial-intelligence-poised-to-double-annual-economic-growth-rate-in-12-developed-economies-and-boost-labor-productivity-by-up-to-40-percent-by-2035-according-to-new-research-by-accenture.htm](http://newsroom.accenture.com/news/artificial-intelligence-poised-to-double-annual-economic-growth-rate-in-12-developed-economies-and-boost-labor-productivity-by-up-to-40-percent-by-2035-according-to-new-research-by-accenture.htm). Accessed 14 Aug. 2023.

*Artificial Intelligence Vs. Human Intelligence.*

[www.simplilearn.com/artificial-intelligence-vs-human-intelligence-article#:~:text=Computers%20have%20the%20ability%20to,ten%20problems%20in%20one%20minute](http://www.simplilearn.com/artificial-intelligence-vs-human-intelligence-article#:~:text=Computers%20have%20the%20ability%20to,ten%20problems%20in%20one%20minute). Accessed 13 Aug. 2023.

*Bias in Algorithms – Artificial Intelligence and Discrimination.*

[fra.europa.eu/sites/default/files/fra\\_uploads/fra-2022-bias-in-algorithms\\_en.pdf](http://fra.europa.eu/sites/default/files/fra_uploads/fra-2022-bias-in-algorithms_en.pdf). Accessed 14 Aug. 2023.

- A Brief History of Chatbots.* chatbotslife.com/a-brief-history-of-chatbots-d5a8689cf52f.  
Accessed 14 Aug. 2023.
- China Sets Out New Rules for Generative AI, with Beijing Emphasising Healthy Content and Adherence to 'Socialist Values'.*  
www.scmp.com/tech/big-tech/article/3227576/china-sets-out-new-rules-generative-ai-beijing-emphasising-healthy-content-and-adherence-socialist. Accessed 14 Aug. 2023.
- Davenport, Thomas, and Ravi Kalakota. "The Potential for Artificial Intelligence in Healthcare." *Future Healthcare Journal*, vol. 6, no. 2, June 2019, pp. 94-98,  
<https://doi.org/10.7861/futurehosp.6-2-94>. Accessed 14 Aug. 2023.
- Deloitte Survey on AI Adoption in Manufacturing.*  
www2.deloitte.com/cn/en/pages/consumer-industrial-products/articles/ai-manufacturing-application-survey.html. Accessed 13 Aug. 2023.
- Economic Potential of Generative AI: A Unique Opportunity for Businesses.*  
www.plainconcepts.com/economic-potential-generative-ai/#:~:text=According%20to%20a%20study%20by,63%20use%20cases%20they%20analyzed. Accessed 13 Aug. 2023.
- The Economic Potential of Generative AI: The Next Productivity Frontier.*  
www.mckinsey.com/capabilities/mckinsey-digital/our-insights/the-economic-potential-of-generative-ai-the-next-productivity-frontier#introduction. Accessed 13 Aug. 2023.
- Estimating the Coefficients of the Linear Regression Model.*  
www.econometrics-with-r.org/4-2-estimating-the-coefficients-of-the-linear-regression-model.html. Accessed 14 Aug. 2023.
- EU General Data Protection Regulation (GDPR).*  
www.pcpd.org.hk/english/data\_privacy\_law/eu/eu.html. Accessed 14 Aug. 2023.
- The European Union's Artificial Intelligence Act - Explained.*  
www.weforum.org/agenda/2023/06/european-union-ai-act-explained/. Accessed 14 Aug. 2023.
- Exploring the Future of Artificial Intelligence — 8 Trends and Predictions for the Next Decade.*  
10 July 2023,  
www.entrepreneur.com/science-technology/8-ai-trends-and-predictions-for-the-next-decade/455115#:~:text=As%20algorithms%20become%20more%20sophisticated,%20making%20and%20problem%20solving. Accessed 31 July 2023.
- "Financial Review." *HSBC Annual Report*,  
www.hsbc.com/investors/results-and-announcements/annual-report. Accessed 14 Aug. 2023.
- From Siri to Alexa: The Evolution and Impact of Global Voice Recognition Software.*  
fagenwasanni.com/news/from-siri-to-alexa-the-evolution-and-impact-of-global-voice-recognition-software/44333/. Accessed 14 Aug. 2023.
- Generative Adversarial Networks (Gans) : A Deep Dive into the Architecture and Training Process.* www.leewayhertz.com/generative-adversarial-networks/. Accessed 14 Aug. 2023.

*A Gentle Introduction to Generative Adversarial Networks (GANs).*  
[machinelearningmastery.com/what-are-generative-adversarial-networks-gans/](https://machinelearningmastery.com/what-are-generative-adversarial-networks-gans/). Accessed 14 Aug. 2023.

*The History of AI in Manufacturing.* [blog.radwell.com/the-history-of-ai-in-manufacturing](https://blog.radwell.com/the-history-of-ai-in-manufacturing). Accessed 30 July 2023.

*How to Interpret a Scale-Location Plot (With Examples).* [www.statology.org/scale-location-plot/](https://www.statology.org/scale-location-plot/). Accessed 13 Aug. 2023.

*How to Use Q-Q Plots to Check Normality.* [www.statology.org/q-q-plot-normality/](https://www.statology.org/q-q-plot-normality/). Accessed 12 Aug. 2023.

*IBM Will Stop Hiring Humans for Jobs AI Can Do, Report Says.*  
[www.forbes.com/sites/nicholasreimann/2023/05/01/ibm-will-stop-hiring-humans-for-jobs-ai-can-do-report-says/?sh=6ec653ca5397](https://www.forbes.com/sites/nicholasreimann/2023/05/01/ibm-will-stop-hiring-humans-for-jobs-ai-can-do-report-says/?sh=6ec653ca5397). Accessed 19 July 2023.

*The Impact of AI on Job Roles, Workforce, and Employment: What You Need to Know.*  
[www.innopharmaeducation.com/news/impact-of-ai-on-workforce-and-employment#:~:text=According%20to%20a%20report%20by%20the%20World%20Economic%20Forum%20C%20by%20job%20displacement%20in%20certain%20industries](https://www.innopharmaeducation.com/news/impact-of-ai-on-workforce-and-employment#:~:text=According%20to%20a%20report%20by%20the%20World%20Economic%20Forum%20C%20by%20job%20displacement%20in%20certain%20industries). Accessed 14 Aug. 2023.

*Industrial Robots: Robot Investment Reaches Record 16.5 Billion USD.*  
[ifr.org/ifr-press-releases/news/robot-investment-reaches-record-16.5-billion-usd](https://ifr.org/ifr-press-releases/news/robot-investment-reaches-record-16.5-billion-usd). Accessed 14 Aug. 2023.

*Introducing ChatGPT.* [openai.com/blog/chatgpt](https://openai.com/blog/chatgpt). Accessed 14 Aug. 2023.

*Investors Are Dropping Billions on Startups in the AI Craze.*  
[finance.yahoo.com/news/investors-dropping-billions-startups-ai-160120618.html](https://finance.yahoo.com/news/investors-dropping-billions-startups-ai-160120618.html). Accessed 13 Aug. 2023.

*Jibo, the Personal Robot Startup, Lands \$25 Million in Funding.*  
[www.entrepreneur.com/starting-a-business/jibo-the-personal-robot-startup-lands-25-million-in/242047](https://www.entrepreneur.com/starting-a-business/jibo-the-personal-robot-startup-lands-25-million-in/242047). Accessed 14 Aug. 2023.

*Jobs Lost, Jobs Gained: Workforce Transitions in a Time of Automation.*  
[www.mckinsey.com/~/media/mckinsey/industries/public%20and%20social%20sector/our%20insights/what%20the%20future%20of%20work%20will%20mean%20for%20jobs%20skills%20and%20wages/mgi-jobs-lost-jobs-gained-executive-summary-december-6-2017.pdf](https://www.mckinsey.com/~/media/mckinsey/industries/public%20and%20social%20sector/our%20insights/what%20the%20future%20of%20work%20will%20mean%20for%20jobs%20skills%20and%20wages/mgi-jobs-lost-jobs-gained-executive-summary-december-6-2017.pdf). Accessed 14 Aug. 2023.

Kim, Dahye. "Tooth Segmentation of 3D Scan Data Using Generative Adversarial Networks." *Applied Sciences*, vol. 10, no. 2,  
[www.researchgate.net/publication/338509383\\_Tooth\\_Segmentation\\_of\\_3D\\_Scan\\_Data\\_Using\\_Generative\\_Adversarial\\_Networks](https://www.researchgate.net/publication/338509383_Tooth_Segmentation_of_3D_Scan_Data_Using_Generative_Adversarial_Networks). Accessed 14 Aug. 2023.

*Linear Regression Plots: Residuals vs Leverage.*  
[boostedml.com/2019/03/linear-regression-plots-residuals-vs-leverage.html](https://boostedml.com/2019/03/linear-regression-plots-residuals-vs-leverage.html). Accessed 13 Aug. 2023.

*The Multiple Linear Regression Equation.*

sphweb.bumc.bu.edu/otlt/mph-modules/bs/bs704-ep713\_multivariablemethods/bs704-ep713\_multivariablemethods2.html. Accessed 14 Aug. 2023.

Perlroth, Nicole. "All 3 Billion Yahoo Accounts Were Affected by 2013 Attack." *The New York Times*, 3 Oct. 2017,

www.nytimes.com/2017/10/03/technology/yahoo-hack-3-billion-users.html. Accessed 14 Aug. 2023.

Pollack, Andrew. "'Fifth Generation' Became Japan's Lost Generation." *The New York Times*, 5 June 1992,

www.nytimes.com/1992/06/05/business/fifth-generation-became-japan-s-lost-generation.html. Accessed 14 Aug. 2023.

*PwC's Global Artificial Intelligence Study: Exploiting the AI Revolution.*

www.pwc.com/gx/en/issues/data-and-analytics/publications/artificial-intelligence-study.html. Accessed 14 Aug. 2023.

*The Replacement of Human Jobs by Artificial Intelligence: Ms. Tang Yu, First AI Robot CEO.*

cyberjustice.blog/2023/01/16/the-replacement-of-human-jobs-by-artificial-intelligence-m-s-tang-yu-first-ai-robot-ceo/#:~:text=In%20September%202022%2C%20a%20shocking,online%20gaming%20and%20mobile%20applications. Accessed 31 July 2023.

*Residuals and Diagnostics For linear regression Using R.*

rpubs.com/Amrabdelhamed611/669768#:~:text=15%20to%2015%20.-,Residuals%20vs%20Leverage,model%20could%20be%20very%20influential. Accessed 12 Aug. 2023.

*Residuals Vs. Fits Plot.*

online.stat.psu.edu/stat462/node/117/#:~:text=When%20conducting%20a%20residual%20analysis,unequal%20error%20variances%2C%20and%20outliers. Accessed 14 Aug. 2023.

*Robots in the Manufacturing Industry: Types and Applications.*

www.wevolver.com/article/robots-in-the-manufacturing-industry-types-and-applications. Accessed 14 Aug. 2023.

*RSE vs  $R^2$ .*

medium.com/humansystemsdata/rse-vs-r%C2%B2-ba8fba098434#:~:text=RSE%20is%20a%20measure%20of,model%20fits%20the%20data%20well. Accessed 14 Aug. 2023.

*Samuel's Checkers Player.* incompleteideas.net/book/ebook/node109.html. Accessed 14 Aug. 2023.

*A Short Story of Jobs and Automation.*

www.weforum.org/agenda/2020/09/short-history-jobs-automation/. Accessed 14 Aug. 2023.

*65 Percent of Tomorrow's Workers Will Have Jobs That Don't Exist Today.*

www.payscale.com/career-advice/65-percent-tomorrows-workers-jobs-dont-exist-today/. Accessed 14 Aug. 2023.

Soori, Mohsen, et al. "Artificial Intelligence, Machine Learning and Deep Learning in Advanced Robotics, a Review." *Cognitive Robotics*, vol. 3, 2023, pp. 54-70, <https://doi.org/10.1016/j.cogr.2023.04.001>. Accessed 14 Aug. 2023.

*Sophia*. [www.hansonrobotics.com/sophia/](http://www.hansonrobotics.com/sophia/). Accessed 14 Aug. 2023.

*Stanford and MIT Study: A.I. Boosted Worker Productivity by 14%—those Who Use It 'will Replace Those Who Don't'*. [www.cnbc.com/2023/04/25/stanford-and-mit-study-ai-boosted-worker-productivity-by-14percent.html](http://www.cnbc.com/2023/04/25/stanford-and-mit-study-ai-boosted-worker-productivity-by-14percent.html). Accessed 13 Aug. 2023.

*Stanford Cart*. [web.stanford.edu/~learnest/sail/oldcart.html](http://web.stanford.edu/~learnest/sail/oldcart.html). Accessed 14 Aug. 2023.

*The Three Different Types of Artificial Intelligence – ANI, AGI and ASI*. [www.ediweekly.com/the-three-different-types-of-artificial-intelligence-ani-agi-and-asi/#:~:text=However%2C%20even%20though%20artificial%20intelligence,artificial%20super%20intelligence%20\(ASI\)](http://www.ediweekly.com/the-three-different-types-of-artificial-intelligence-ani-agi-and-asi/#:~:text=However%2C%20even%20though%20artificial%20intelligence,artificial%20super%20intelligence%20(ASI)). Accessed 30 July 2023.

*3 Ways Artificial Intelligence Will Transform the World in 2023*. [www.entrepreneur.com/science-technology/the-3-biggest-artificial-intelligence-ai-trends-in-2023/439434](http://www.entrepreneur.com/science-technology/the-3-biggest-artificial-intelligence-ai-trends-in-2023/439434). Accessed 31 July 2023.

*Top 10 Generative Artificial Intelligence Companies to Invest in*. [finance.yahoo.com/news/top-10-generative-artificial-intelligence-154307893.html](http://finance.yahoo.com/news/top-10-generative-artificial-intelligence-154307893.html). Accessed 19 July 2023.

*Turing Test*. [www.sciencedirect.com/topics/neuroscience/turing-test](http://www.sciencedirect.com/topics/neuroscience/turing-test). Accessed 14 Aug. 2023.

*A Video Game Company Made a Bot the Ceo, and Its Stock Climbed*. [www.businessinsider.com/video-game-company-made-bot-its-ceo-stock-climbed-2023-3#:~:text=In%20August%2C%20the%20Chinese%20gaming,its%20subsidiary%2C%20Fujian%20NetDragon%20Websoft](http://www.businessinsider.com/video-game-company-made-bot-its-ceo-stock-climbed-2023-3#:~:text=In%20August%2C%20the%20Chinese%20gaming,its%20subsidiary%2C%20Fujian%20NetDragon%20Websoft). Accessed 14 Aug. 2023.

*A Vision for Prioritizing Human Well-being with Autonomous and Intelligent Systems*. [standards.ieee.org/wp-content/uploads/import/documents/other/ead\\_v2.pdf](http://standards.ieee.org/wp-content/uploads/import/documents/other/ead_v2.pdf). Accessed 14 Aug. 2023.

Wakefield, Jane. "Foxconn Replaces '60,000 Factory Workers with Robots.'" *BBC*, 25 May 2016, [www.bbc.com/news/technology-36376966](http://www.bbc.com/news/technology-36376966). Accessed 14 Aug. 2023.

*What Are the 3 Types of AI? A Guide to Narrow, General, and Super Artificial Intelligence*. [codebots.com/artificial-intelligence/the-3-types-of-ai-is-the-third-even-possible](http://codebots.com/artificial-intelligence/the-3-types-of-ai-is-the-third-even-possible). Accessed 14 Aug. 2023.

*What Is Artificial Intelligence?* [www.hpe.com/hk/en/what-is/artificial-intelligence.html](http://www.hpe.com/hk/en/what-is/artificial-intelligence.html). Accessed 14 Aug. 2023.

*What Is Artificial Intelligence (AI)? Definition, Types, Goals, Challenges, and Trends in 2022*. [www.spiceworks.com/tech/artificial-intelligence/articles/what-is-ai/](http://www.spiceworks.com/tech/artificial-intelligence/articles/what-is-ai/). Accessed 14 Aug. 2023.

*What Is Financial Modeling?* [corporatefinanceinstitute.com/resources/financial-modeling/what-is-financial-modeling/](http://corporatefinanceinstitute.com/resources/financial-modeling/what-is-financial-modeling/). Accessed 14 Aug. 2023.

*What Is Generative AI? Everything You Need to Know.*

[www.techtarget.com/searchenterpriseai/definition/generative-AI](http://www.techtarget.com/searchenterpriseai/definition/generative-AI). Accessed 13 Aug. 2023.

*What Is the History of Artificial Intelligence (AI)?*

[www.tableau.com/data-insights/ai/history#:~:text=Birth%20of%20AI%3A%201950%2D1956&text=Alan%20Turing%20published%20his%20work,and%20came%20into%20popular%20use](http://www.tableau.com/data-insights/ai/history#:~:text=Birth%20of%20AI%3A%201950%2D1956&text=Alan%20Turing%20published%20his%20work,and%20came%20into%20popular%20use). Accessed 30 July 2023.

*What's the Real Value of AI for Your Business and How Can You Capitalise?*

[www.pwc.com/gx/en/issues/data-and-analytics/publications/artificial-intelligence-study.html](http://www.pwc.com/gx/en/issues/data-and-analytics/publications/artificial-intelligence-study.html). Accessed 14 Aug. 2023.

*Why Companies Are Reluctant to Jump on the ChatGPT Bandwagon.*

[www.scmp.com/comment/opinion/article/3220347/why-companies-are-reluctant-jump-chatgpt-bandwagon?module=perpetual\\_scroll\\_0&pgtype=article&campaign=3220347](http://www.scmp.com/comment/opinion/article/3220347/why-companies-are-reluctant-jump-chatgpt-bandwagon?module=perpetual_scroll_0&pgtype=article&campaign=3220347). Accessed 14 Aug. 2023.

*Why Do PwC Say AI Will Add 14% to Global GDP?*

[aigovernance.co.uk/why-do-pwc-say-ai-will-add-14-to-global-gdp/#:~:text=This%20report%20from%20PwC%20reckons,in%20today's%20fast%20changing%20economy%E2%80%9D](http://aigovernance.co.uk/why-do-pwc-say-ai-will-add-14-to-global-gdp/#:~:text=This%20report%20from%20PwC%20reckons,in%20today's%20fast%20changing%20economy%E2%80%9D). Accessed 14 Aug. 2023.

# **The Effects of Lotion Sunscreen Compared to Spray Sunscreen in Protecting the Skin from Skin Cancer Caused by UV Radiation Using Yeast Cells by Abigail Truong & Karl Martens**

## **Abstract**

The purpose of this experiment was to test whether the form of sunscreen (between lotion and spray) affects the development of skin cancer. In this experiment, bread yeast was used to evaluate the difference in the effects of the different forms of sunscreen. Bread yeast was put onto agar in a petri dish and covered with plastic wrap, which was each covered with a form of sunscreen. These petri dishes were put into a cabinet with UV light, then placed into an incubator overnight. The next day, results and observations were recorded. There was a higher percentage of bread yeast growth on the petri dish covered by lotion than by spray. Consequently, lotion sunscreen is more effective compared to spray sunscreen in protecting the skin cancer from UV radiation.

## **Background**

Skin cancer is uncontrolled growth of abnormal skin cells usually because of UV radiation. It is caused by the destruction of DNA in a person's skin cells by UV rays produced by the sun. (Cleveland Clinic) UV rays provide vitamin D to the human body. However, exposure to too much UV radiation harms the DNA within a human's skin cells. This destruction of DNA in a person's skin cells causes mutations to form within the skin cells therefore resulting in skin cancer.

In addition, yeast is a fungus normally found on a human's skin. (Johns Hopkins Medicine) Bread yeast is a type of yeast and is photosensitive because it contains yeast cytochromes which are photoreceptors that inhibit the effects of light. (PubMed) Photosensitivity means bread yeast is sensitive to sunlight, just like the skin is. This is the reason for the use of bread yeast in the experiment. When bread yeast cells are exposed to UV radiation, bread yeast colonial growth decreases. So, the less bread yeast cells exposed to UV rays, then the more growth will occur.

Sunscreen protects the skin and helps prevent sunburn and skin cancer. Most sunscreen companies include physical blockers, such as zinc oxide, in sunscreen. (Scientific Research Journal) When put on the skin, these blockers reflect UV rays from the skin, consequently protecting the skin from the sun. Moreover, sunscreens contain a sun protection factor (SPF). SPF is a measure of how much UV radiation is required to produce a sunburn on protected skin as opposed to unprotected skin. As the SPF value increases, sunburn protection increases. Different forms of sunscreens have different protection levels on the UV levels for the skin. This experiment was designed to evaluate the effects of lotion sunscreen and spray sunscreen in protecting the skin from UV radiation.

## **Hypothesis**

If the Coppertone Complete 50 sunscreen lotion and Coppertone Complete 50 sunscreen spray are both tested, then the Coppertone Complete 50 sunscreen lotion will grow less yeast compared to the Coppertone Complete 50 sunscreen spray and therefore be more effective in protecting the skin more from developing skin cancer from the sun.

### **Materials**

- Coppertone Complete 50 lotion sunscreen
- Coppertone Complete 50 spray sunscreen
- Safety gloves
- Goggles
- 2 YED (yeast extract-dextrose) agar plates
- 0.5 mL of bread yeast (*saccharomyces cerevisiae*)
- 2 test tubes each with 0.5 mL of sterile water
- Safety glass cabinet with UV light
- Timer
- Incubator

### **Procedure**

1. Put on safety gloves and goggles.
2. Obtain 2 sterile, capped, test tubes each with 0.5 mL of sterile water.
3. Obtain 1 sterile pipet (Note: When opening a pipet, open the wrapper on the bulb side. When using a pipet, only touch the bulb. This ensures that the pipet remains sterile.)
4. Using the sterile pipet, add about 0.25 mL of bread yeast (*saccharomyces cerevisiae*) to each test tube.
5. Cap the tubes tightly and shake gently to mix the yeast cells into the water (Note: the water should look slightly cloudy)
6. Obtain 2 YED (yeast extract-dextrose agar: a growth medium for yeast) plates.
7. Label the plates as described: label the edge on the agar side of the plate. Label one plate spray. Label the other plate lotion. Label both plates with your name and the date. Label the lids of each plate with this information as well.
8. Lift the lid of one YED agar plate just enough to allow the neck of one of the test tubes containing the bread yeast to enter.
9. Pour the entire contents of the tube onto the surface of the YED agar and replace the lid on the petri dish plate.
10. Shake the petri dish plate gently side to side until all the yeast has spread across the entire surface of the agar.
11. Let the plates sit until the excess liquid has soaked into the agar.
12. On a square of plastic wrap, lightly spray the Coppertone Complete 50 spray sunscreen on top of the plastic wrap.
13. Fold the plastic wrap in half.



14. Remove the lid from the plate labelled spray and quickly cover the plate with the plastic wrap. Make sure the plastic wrap is pulled tight and does not touch the surface of the plate.
15. Repeat step 14 with the lotion plate, making sure to lightly spread 2 drops of lotion sunscreen with a finger.
16. Place both plates into the safety glass cabinet and close the door.
17. Turn on the UV light for 2 minutes.
18. After the 2 minutes are over, remove the plastic wrap from both plates.
19. Replace the lids with their appropriate petri dish plates.
20. Cover both petri dish plates completely with aluminum foil.
21. Place both petri dish plates with the agar side up inside the incubator.
22. Leave the petri dish plates inside the incubator overnight at 30°C.

## Results

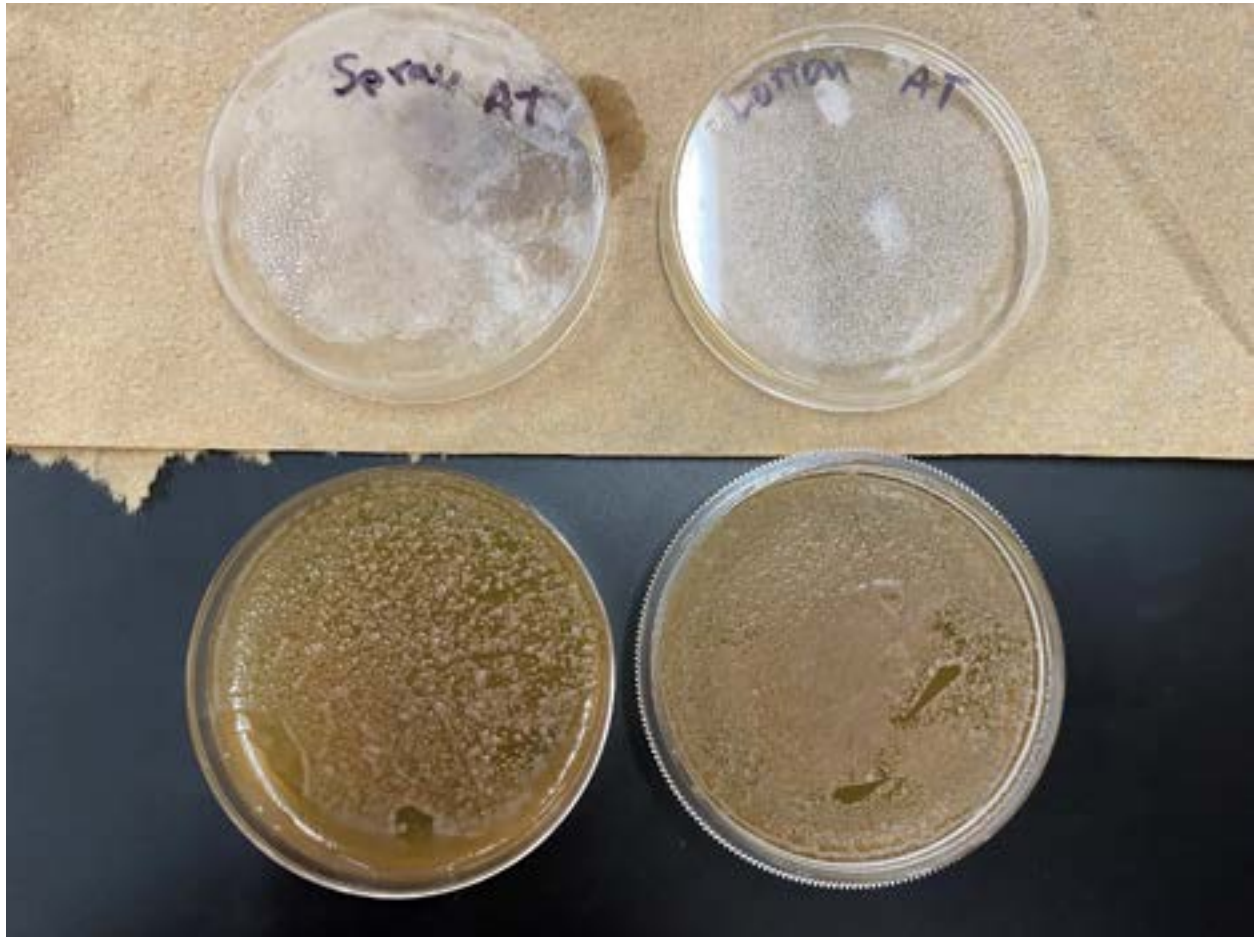

Figure 1. This is an image showing the results of the experiment conducted.

Based off Figure 1, the lotion sunscreen petri dish is whiter than the spray sunscreen petri dish. The whiteness depicts bread yeast colonial growth. The lotion sunscreen petri dish showed a 96% bread yeast colonial growth compared to the spray sunscreen petri dish's 62% bread yeast colonial growth.

### **Discussion**

The whiter the petri dish, then the more bread yeast growth. The more bread yeast growth there is, the more effective the form of sunscreen is in protecting the skin from UV radiation from the sun. Based off Figure 1, the lotion sunscreen petri dish turned whiter compared to the spray sunscreen petri dish. Consequently, the lotion sunscreen is more effective in protecting the skin from UV radiation. So, the results of this experiment support the hypothesis. In addition, the results support the background information because bread yeast proved to be a reliable bacterium in showing UV level protection. In addition, the results support the background information because the two different forms of sunscreen had different effects on the UV level protection.

A possible error in the experiment is the amount of sunscreen applied to the plastic wrap before placed on the petri dishes. A different amount between the different forms of sunscreen could affect the results of this experiment. To solve this error, a set amount of sunscreen should be recorded in the materials section, such as 0.5 ounces. To expand on this experiment, another experiment that could be conducted is redoing this same experiment with the same steps except applying 0.25 ounces of spray sunscreen on the spray sunscreen plastic wrap and applying 0.25 ounces of lotion sunscreen on the spray sunscreen plastic wrap. This would ensure that an equal amount of each form of sunscreen was applied. In another expanded experiment, water could be another factor. How will water affect the UV protection levels between spray sunscreen and lotion sunscreen? Water would be applied to both the spray and lotion sunscreen in this experiment.

### **Conclusion**

Lotion sunscreen provides better UV protection as evidenced by increased yeast growth

### Works Cited

- Cleveland Clinic. "Ultraviolet (UV) Radiation: What It Is & Its Effect on Your Skin." *Cleveland Clinic*. Accessed 27 Mar. 2024.  
[my.clevelandclinic.org/health/diseases/10985-ultraviolet-radiation](https://my.clevelandclinic.org/health/diseases/10985-ultraviolet-radiation).
- Johns Hopkins Medicine. "Yeast Infection." *Johns Hopkins Medicine*. Accessed 27 Mar. 2024.  
[www.hopkinsmedicine.org/health/conditions-and-diseases/candidiasis-yeast-infection#:~:text=Yeast%20is%20a%20fungus%20normally,yeast%20in%20your%20vaginal%20are](https://www.hopkinsmedicine.org/health/conditions-and-diseases/candidiasis-yeast-infection#:~:text=Yeast%20is%20a%20fungus%20normally,yeast%20in%20your%20vaginal%20are)
- SCIRP. "The Effect of Sunscreens on Yeast to Prevent Ultraviolet Damage." *SCIRP*, Scientific Research Publishing. Accessed 28 Mar. 2024.  
[www.scirp.org/journal/paperinformation?paperid=99666#:~:text=It%20is%20also%20found%20that,growth%20of%20the%20yeast%20cells](https://www.scirp.org/journal/paperinformation?paperid=99666#:~:text=It%20is%20also%20found%20that,growth%20of%20the%20yeast%20cells).
- PubMed. "Light Effects in Yeast: Evidence for Participation of Cytochromes in Photoinhibition of Growth and Transport in *Saccharomyces Cerevisiae* Cultured at Low Temperatures." *Journal of Bacteriology*, U.S. National Library of Medicine. Accessed 28 Mar. 2024.  
[www.ncbi.nlm.nih.gov/pmc/articles/PMC218208/#:~:text=The%20results%20suggest%20therefore%20that,biological%20rhythms%20in%20this%20species](https://www.ncbi.nlm.nih.gov/pmc/articles/PMC218208/#:~:text=The%20results%20suggest%20therefore%20that,biological%20rhythms%20in%20this%20species).

# **Utilizing ChatGPT to Determine a Plant's Watering Schedule and Automatically Administer Water via a Motor-Based Valve by Sophia Dong and Emmanuel Mayssat**

## **Abstract**

This research explores the integration of AI technologies, specifically ChatGPT, in imaging systems and automating plant watering schedules through motor-based valve systems. With the growing importance of the internet, this study investigates the feasibility of utilizing ChatGPT alongside motorized ball valves for smaller-scale watering systems. The methodology involved designing circuit boards, analyzing valve temperatures, and configuring ChatGPT for image-based watering schedules.

Data analysis revealed the effectiveness of motor ball valves over solenoid valves in maintaining temperature stability. ChatGPT's imaging function GPT-4 successfully generated watering schedules based on plant images. Overall, the study highlights the broader implications of integrating AI technologies in plant care and suggests future research directions for improving system integration and modifying the project to a broader scale.

## **Introduction**

With the rise of the internet of living things (IoLT), we are able to more meaningfully connect with our world, particularly through plants. By using a network of electronic devices embedded into objects, these devices essentially act as “digital glasses,” allowing us to track a plant's behavior more efficiently and accurately, which enables us to perform more measurements (Sørensen, Lansing, 2023). Currently, ESP32 cameras are popular among IoLT hobbyists due to their beginner-friendly traits such as low power consumption, easy Wi-Fi and Bluetooth connectivity, making it easy to connect to external servers such as ChatGPT (Dronebot Workshop, 2023). Using these technologies in tandem with current watering systems opens up possibilities of creating automatically powered watering systems, offering a plethora of advantages such as efficiency, convenience, and cost-effectiveness (Iqbal, et.al, 2022). Currently, solenoid valves are more widespread because they're able to control the water flow better (Dombor, 2022). However, motorized ball valves, while less accurate, are more useful for smaller-scale projects, such as the one outlined below. Requiring minimal effort to switch, these valves are also more corrosion-resistant, ensuring a longer lifetime usage. Although electronically-driven irrigation systems offer a plethora of they are not without their share of obstacles, notably encompassing substantial initial investments, constrained adaptability, and maintenance requirements. Additionally, there are many tradeoffs which the researcher may encounter; some examples include making an effective prompt for ChatGPT so it can provide concise outputs and creating an imaging interface system connecting ChatGPT to a circuit microcontroller; both of the aforementioned issues arise from the fact that sending images to ChatGPT is a fairly new process, with few resources documenting the process (Rogers, 2023). As a result, hobbyists might find it difficult to effectively implement such technologies, particularly those with little to no experience. This inquiry seeks to create a functioning imaging

system that is easily replicable, ensuring optimal performance and sustainability in electronically-driven watering systems to automatically administer a given amount of water. A new device satisfying all the above criteria will pave the way for new utilizations of ChatGPT, possibly expanding to video detection.

The AI technologies available to us through ChatGPT are language models, machine learning, deep learning, and neural networks (Dronebot Workshop, 2023). These various mechanisms have been used to perform numerous tasks ranging from response generation to image identification. However, there isn't much data available demonstrating the efficacy of utilizing the latter technology to achieve a specific goal, such as creating a watering schedule, exporting the instructions in Json format, and having it communicate with a Wi-Fi module or microcontroller. Due to the preciseness of robots, such applications can translate to agriculture, which currently accounts for 70% of global freshwater demand (Iqbal *et al.*, 2022), and reduce water waste.

Additionally, because climate change is creating increasing challenges for plants to develop resilience, it is critical that the tools keep pace and continually adapt to the changing needs of today's agriculture. According to Benos *et. al* (2021), agriculture is increasingly being used in tandem with AI due to its efficiency. AI enables machines within the system to directly communicate with each other, potentially allowing the system to improve itself based on information inputs without the need for human interference, making plant monitoring less time-consuming. Through a series of studies, Benos's team tested various aspects by measuring the effectiveness of AI at managing crop growth based on focusing on various detection factors such as plant soil moisture and satellite spectral data as well as different ways of detection. From these studies, they found that artificial neural networks were the most efficient. While they also found that the more factors they measured, the more accurate the results, measuring too many factors might make compiling the data difficult. These promising outcomes have led to the development of technologies including rovers utilizing AI detection (XMineral, 2023) which are able to create a more thorough picture of a plant's needs.

Numerous studies have explored the integration of AI-powered technologies, such as soil moisture sensors and precision irrigation systems in sustainable agriculture. Researchers like Iqbal *et al.* (2022) and Phukan (2022) have demonstrated the potential of these technologies in conserving water resources and increasing crop yields. Moreover, according to the European Science-Media Hub, AI will eventually have the ability to connect data together from machines which then can derive conclusions based on data and other factors which might not be as obvious, even to a highly experienced farmer. To go even further, AI can optimize supply chains by ensuring that produce is "refined" and delivered when and where it is needed. For this reason, AI is beginning to make its way to European farms as governments see the powerful means with which it can support European agriculture.

There presently exist two main types of watering valves: solenoid valves and motorized ball valves. The former utilizes an electromotive force created by a movable electrode and solenoid coil, which increases the cost, and power dissipated. As a result, such mechanisms are

used in industrial-scale settings, and currently, are more widely employed. Meanwhile, the motor ball valve is simply opened and closed using a motor (Dombor, 2022), making it easy to employ for smaller-scale projects. It dissipates less power and is more cost-effective than its counterpart.

However, while these studies emphasize the usefulness of such technology in aiding plant growth, there remains a critical unanswered question on whether this technology can be implemented on a larger scale. There is a lack of comprehensive studies as the current research provides a surface-level understanding for AI applications (Benos et. al, 2021). Additionally, current technologies can only generate data sets for a limited area, often overlooking the realistic implication of a bigger issue. Many farmers are also not AI experts, and as such it's imperative to create an efficient, easy-to-use tool that can be widely distributed among individuals.

To bridge this gap, it is essential to conduct rigorous testing of AI technologies on smaller scales before their widespread adoption. While there are current efforts to utilize ChatGPT's imaging capabilities in radiology (Srivastav et. al, 2023), applications remain quite limited. This study seeks to address this imperative by developing and evaluating AI-driven adaptive watering systems in tandem with efficient valve systems. By focusing on reliability and ease of use, the study aims to create a robust solution that can be applied into a bigger scale. As the world increasingly relies on AI technology, the digitalizing agriculture sector enables farmers to use their land more efficiently and thus, produce more yield. It also reduces labor costs, allowing farmers to focus their efforts on other matters such as creating plots for other crops that are less commonly mass-produced.

## **Methodology**

The methodology for this research was focused on exploring and understanding ways we could use AI identification and soil moisture sensors in tandem to accordingly water plants, ensuring a deep and comprehensive analysis of the subject matter. Images would be taken by an ESP32 camera, uploaded into a server, and then sent into ChatGPT, which would consequently output a watering schedule in json file format. The json file would be returned to the Wi-Fi module and communicated to the microcontroller to water the plants accordingly.

To analyze the data from designing and fabricating a board with a PIC16F18445 microcontroller, field notes were taken documenting the process of each stage.

Descriptive research was also utilized when collecting data that measured temperature of a motor ball-powered valve and a solenoid-powered valve. To collect the necessary quantitative data for the study, a combination of Field Notes, Observations, and Databases such as Google Sheets was used, ensuring the gathering of rich, multifaceted information relevant to my research objectives. Using a thermometer and a video camera, data points were collected and plotted on a graph with axes temperature v. time. Google Sheets was used to create graphs demonstrating the trend between temperature and time. The primary goal of the second part was to uncover patterns relevant to creating an efficient, reliable, and long-lasting watering system.

For analyzing the collected data, coding and descriptive statistics techniques were employed. To identify the statistical significance of the success, Google sheets created graphs

representing the findings. Comparing the points to a best-fit on these graphs indicated the accuracy of the measurements found early in the procedure.

The data collected was both quantitative and qualitative. To create a setup of the experiment, information was collected from other databases. To measure the effectiveness of the ESP32 camera and ChatGPT, field notes documenting observations determined if both technologies could consistently produce accurate results, namely taking pictures every thirty seconds and producing an output with an accurate watering schedule respectively. Based on these previous observations, revisions were made to continually enhance the functionalities of both technologies. This section aimed to document the results of a functioning image generator to serve as a guide for individuals seeking to replicate the paper's goal.

Through rigorous data analysis and ethical research practices, this study sought to uncover the most effective methods of creating an image-motivated algorithm that produced a watering system.

## Data and Results

### Part 1: Making the Circuit

In this section, a board schematic and PCB layout was designed in KiCAD. After having a private company manufacture the board, surface-mounted components were soldered on the resulting circuit board.

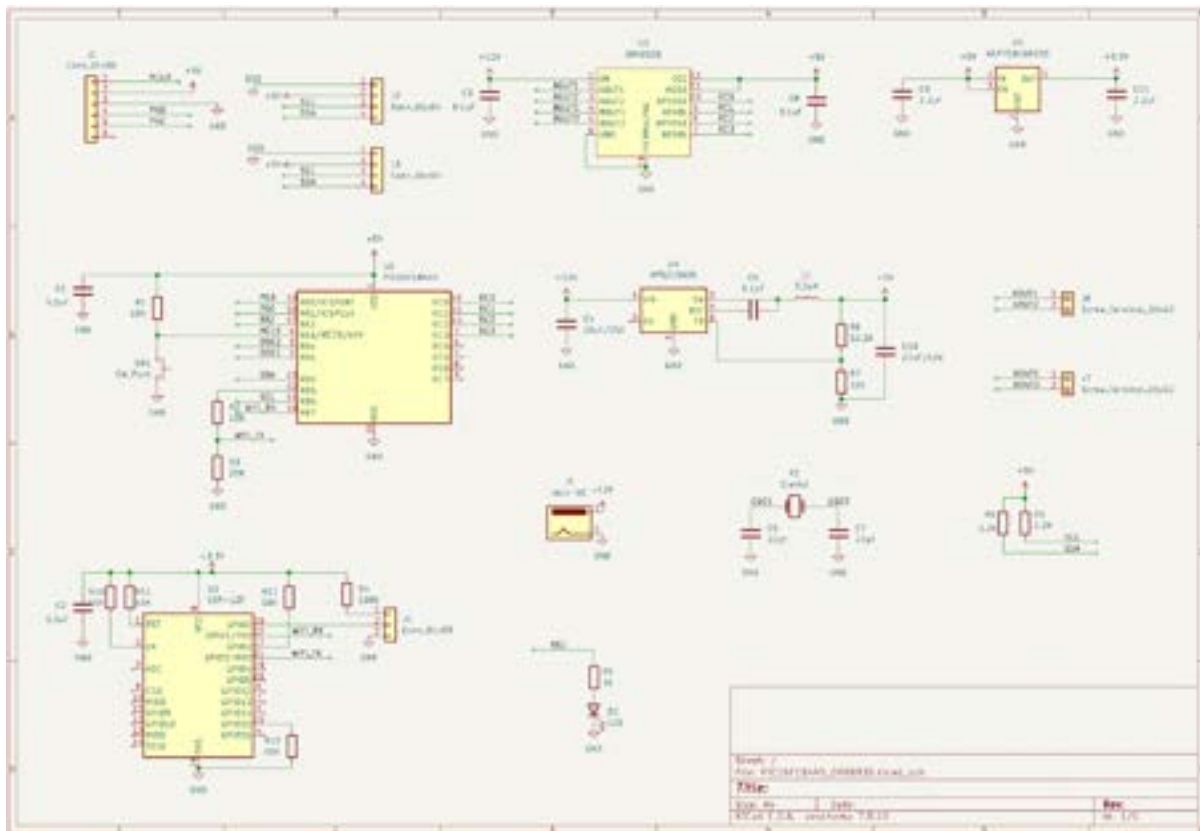

Figure 2: Displayed above is the schematic of the circuit. The PIC16F18445 and Wi-Fi module shown on the left will provide directions to open the motor ball valve used and communicate with GPT4-V respectively.

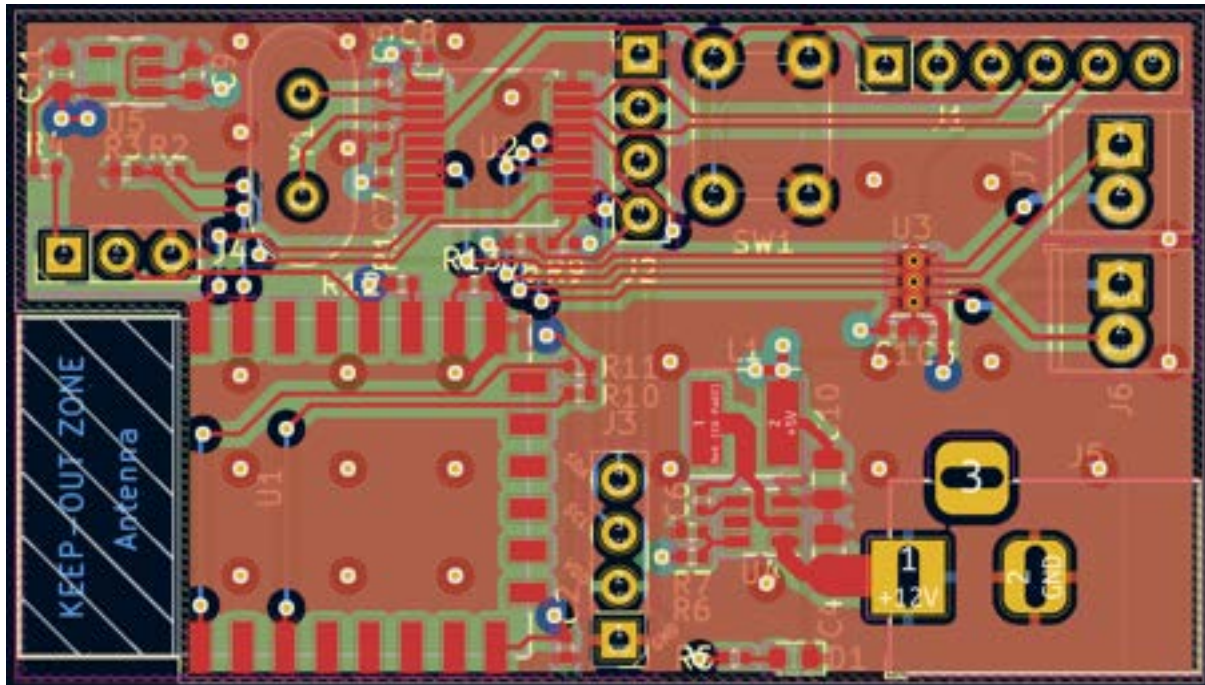

Figure 3: The PCB layout of our circuit converts the schematic to the real components and uses real traces to connect all these components. To accommodate the necessary wire traces without short-circuiting, this board contains four layers, each connected with vias.

### Part 2: Choosing a Valve

In this section, a solenoid valve and motor ball valve's temperatures were compared to determine the more efficient mechanism. Temperature measurements were recorded by a camera and subsequently plotted on the y-axis of a graph, with time serving as the independent variable.



Solenoid Valve Temperature (F) vs. Time (s)

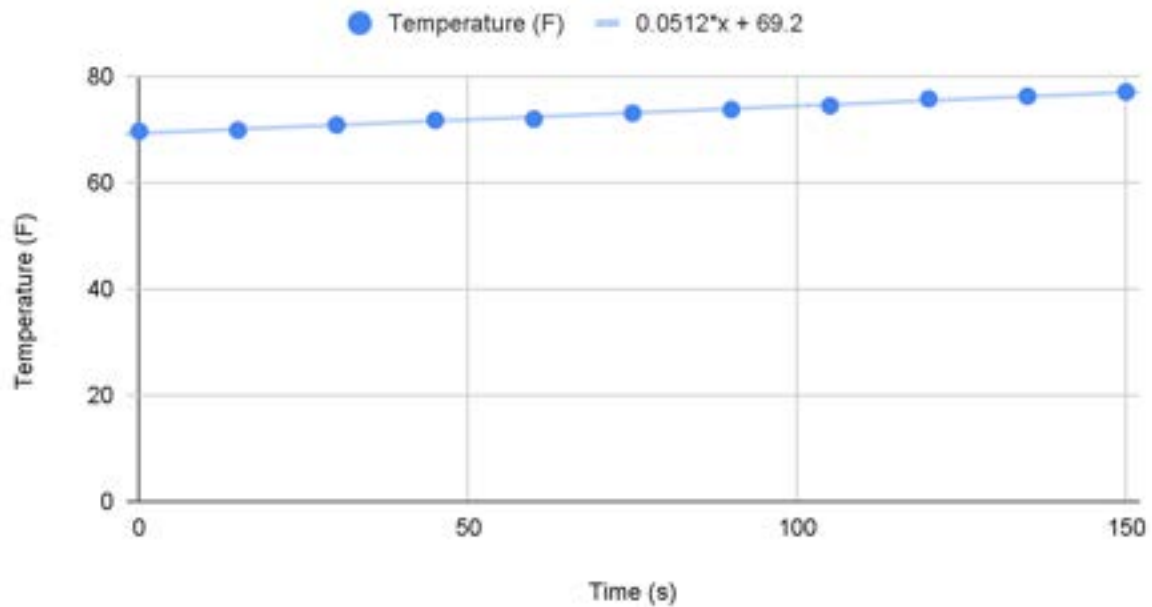

Figure 4: Starting from room temperature, about 70 degrees Fahrenheit, this graph demonstrates a linear relationship between a solenoid valve’s temperature plotted as a function of time.

Motor Valve Temperature (F) vs. Time (s)

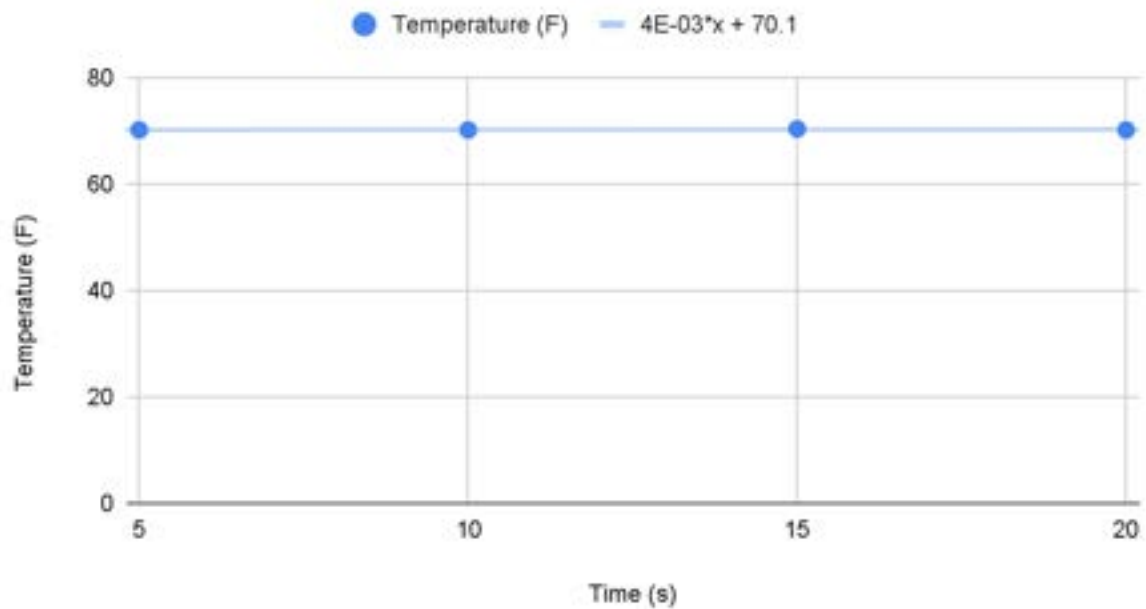

Figure 5: When observing motor valve temperature plotted as a function of time, the trend is a straight line, indicating negligible temperature changes.



Figure 6: Shown above is the ball-motor valve attached to the PVC watering system.

### Part 3: Configuring the Camera and ChatGPT

Additionally, a system where images can be captured and uploaded to the server was established.



Figure 7a: Shown above is the ESP32-CAM model purchased. Image source: AiTRIP, “AITRIP 1 PCS ESP32 ESP32-WROVER Board with Camera WiFi & Bluetooth Development Board Compatible with Arduino IDE”, 2024. Accessed via <https://www.amazon.com/AiTrip-ESP32-CAM-Bluetooth-Dual-core-Development/dp/B09ZJTVPNW?th=1>

### ESP32-CAM Photo Gallery



Figure 7b: Utilizing an ESP32 Camera and Python code, pictures were taken every 30 seconds and uploaded to a server, leading to relevant updates for ChatGPT to read.

ChatGPT was successfully configured to generate a JSON file containing a watering schedule based on an input image of a plant.

```
payload = {
  "model": "gpt-4-vision-preview",
  "messages": [
    {
      "role": "user",
      "content": [
        {
          "type": "text",
          "text": "Give me ONLY the watering schedule ONLY in the json document format. No text."
        },
        {
          "type": "image_url",
          "image_url": {
            "url": f"data:image/jpeg;base64,{base64_image}"
          }
        }
      ]
    }
  ],
  "max_tokens": 300
}

response = requests.post(url="https://api.openai.com/v1/chat/completions", headers=headers, json=payload)

response_json = response.json()
schedule = response_json['choices'][0]['message']['content']
# schedule = response_json["content"]
print(schedule)
```

Figure 8a: The code displayed interacts with GPT4-V, utilizing prompt engineering to ask the

software to return a watering schedule in the format shown in figure 5.

```
```json
{
  "watering_schedule": {
    "frequency": "weekly",
    "amount": "moderate",
    "best_time": "morning"
  }
}
```

Figure 8b: An example response generated by ChatGPT based on the code from Figure 5a.

### **Discussion, Analysis, and Evaluation**

The findings of my study demonstrate the efficacy of an imaging application utilizing ChatGPT, which could potentially be more widespread in the future. There were also numerous components regarding circuit construction that were discovered. The design and construction of the circuit board required substantial background knowledge, particularly in using KiCAD for layout and in selecting appropriate components. Practical skills such as soldering surface-mounted components were also essential to create a functioning product, necessitating a high level of expertise.

There were several main challenges encountered during the building of the circuit, one of which was avoiding short circuits. To mitigate this issue, we used a four-layered board design, placing traces on different layers. Moreover, VIAs were employed to shorten voltage traces, resulting in a more compact and efficient layout. Laying out the components in a compact and functional manner also proved difficult. Specific components had placement restrictions; for example, the Wi-Fi module, used for cloud interfacing, required its antenna to be on the edge of the board to function properly while components like jacks and programmers needed to be easily accessible, so they were placed on the sides of the board. The LED, an important status indicator, also had to be positioned for visibility to indicate the status of the circuit during debugging.

The selection and design of components for the valves required a deep understanding of circuit-building. For instance, the ball motor valve was chosen over the solenoid valve due to its superior performance. The motor valve exhibited better sustainability and efficiency, with the data clearly showing its advantages over the solenoid valve. Graphs evaluating the performance

of both valves over time highlighted the solenoid valve's propensity to overheat, with temperatures exceeding 100 degrees Fahrenheit, leading to potential equipment degradation. In contrast, the motor valve maintained a stable temperature close to room temperature, making it more practical for our purposes.

In addition to the circuit and valve designs, the project involved configuring an image identification system using GPT-4 Vision, ChatGPT's imaging function, and a water schedule generator. This required trial and error to determine the optimal commands for GPT-4 Vision, and the use of external resources to find suitable codes for the ESP camera. Debugging this system was challenging and time-consuming, but ultimately successful. The image-processing feature of GPT-4 Vision, despite a runtime of approximately 15 seconds, did not significantly impact the accuracy of watering schedule recommendations.

Programming microcontrollers with MicroPython presented its own set of challenges. Given the limitations of my expertise, such code may be too complicated for me to integrate into my current setup. Instead, pivoting to using an Arduino, which offers more robust computational capabilities, or utilizing a Raspberry Pi mini-computer could offset these complications by allowing me to directly communicate with the valve controls easier. This entails improved processing power and flexibility for future enhancements, streamlining the process and offering more efficient solutions.

In conclusion, throughout the project, I gained significant insights into various aspects of circuit design while also building on previous skills I acquired from various other projects, including a previous keyboard. I learned to use different functionalities of CAD software and how to read datasheets effectively. Additionally, I developed techniques to make circuit-building more compact and understood the intricacies of different circuit components. This project provided valuable learning experiences and demonstrated the practical applications of circuit-building and component integration. The challenges encountered led to a deeper understanding of both the technical and practical aspects of electronics design and implementation.

### **Conclusions, Implications and Next Steps**

The findings of our study suggest the feasibility of integrating imaging features with ChatGPT, while also demonstrating the efficacy of ball valves within watering systems. These results hold significant implications, particularly for hobbyists, these discoveries indicate the way for greater accessibility and adoption of these technologies on a wider scale. Furthermore, the application of ChatGPT in imaging extends beyond watering systems, potentially influencing various other fields, thus expanding the horizon of technological innovation. While our study contributes to existing knowledge, it diverges by highlighting the broader potential of these technologies, signaling a shift in perspective.

However, it's important to acknowledge the limitations of the research, primarily stemming from struggles to link the ChatGPT json command and the PIC16F88 microcontroller. Moving forward, future research endeavors should prioritize the integration of components to

develop a more comprehensive system either by using MicroPython or switching the circuit board to an Arduino or another device with a built-in computer, thereby enabling a more direct evaluation of its effectiveness. This not only opens avenues for further exploration and development but also highlights the broader applicability of ChatGPT across different mediums and in conjunction with other technologies, ultimately enhancing the accuracy and functionality of the final product.

Moreover, the potential applications of GPT4-Vision in imaging warrant further investigation, offering opportunities to explore diverse functionalities, including the measurement of humidity and temperature. Additionally, the wider implementation of motor ball valves holds promise for optimizing watering systems, ensuring more efficient water distribution and resource utilization.

In the forthcoming stages of our research, bridging the gap between these disparate components through meticulous programming with MicroPython or Arduino becomes the principal goal, while also considering the components of water transportation within the watering system. By leveraging these insights and advancements, realizing a fully integrated, efficient, and technologically advanced solution will not only enhance the functionality of watering systems but also emphasize the transformative potential of AI-driven technologies in other areas.

## Works Cited

- AspiringYouths. (2023, September 19). *Advantages and disadvantages of soil moisture sensor*. AspiringYouths. Retrieved October 2, 2023, from <https://aspiringyouths.com/advantages-disadvantages/soil-moisture-sensor/>
- Ayaa, K. M., El-Behairy, U. A., El-Bagoury, K. F., & El-Gindy, A. M. (2019). Automatic irrigation by using soil moisture sensor in vertical closed system for lettuce production. *Arab Universities Journal of Agricultural Sciences*, 27(1), 77-82. <https://doi.org/10.21608/ajs.2019.43068>
- Benos, L., Tagarakis, A. C., Dolias, G., Berruto, R., Kateris, D., & Bochtis, D. (2021). Machine Learning in Agriculture: A Comprehensive Updated Review. *Sensors (Basel, Switzerland)*, 21(11), 3758. <https://doi.org/10.3390/s21113758>
- Dikshit, R., Padmanabhan, P., Kumar, S., & Singh, U. K. (2021). Soil moisture calculator using iot sensor. *Turkish Online Journal of Qualitative Inquiry*, 12(6), 9989-9999. <https://doi.org/10.21162/PAKJAS/22.846>
- European Science-Media Hub. (2021, September 29). *AI in agriculture: benefits and challenges ahead*. Retrieved October 24, 2023, from <https://sciencemediahub.eu/2021/09/29/ai-in-agriculture-benefits-and-challenges-ahead/>
- Iqbal, U., Bakhsh, A., Shahid, M. A., Hussain Shah, S. H., & Ali, S. (2022). Performance assessment of indigenized soil moisture sensors for improved irrigation scheduling and maize production. *Pakistan Journal of Agricultural Sciences*, 59(4), 661-676. <https://doi.org/10.21162/PAKJAS/22.846>
- Phukan, A. (n.d.). Hydroponics using IOT and machine learning [pdf]. *International Research Journal of Engineering and Technology*. <https://www.irjet.net/archives/V9/i10/IRJET-V9I1035.pdf>
- PR Newswire. (2019, October 9). Global soil moisture sensor industry. *Newspaper Source Plus*. Retrieved September 5, 2023, from <https://research.ebsco.com/linkprocessor/plink?id=225605e7-0324-3a76-89f3-c485e972b27a>
- Sørensen, V., & Lansing, S. J. (2023, May 16). *Art, technology and the internet of living things*. SpringerLink. Retrieved October 2, 2023, from [https://link.springer.com/article/10.1007/s00146-023-01667-4#:~:text=The%20Internet%20of%20Living%20Things%20\(IOLT\)%20is%20potentially%20an%20even,people%20aand%20other%20living%20things.](https://link.springer.com/article/10.1007/s00146-023-01667-4#:~:text=The%20Internet%20of%20Living%20Things%20(IOLT)%20is%20potentially%20an%20even,people%20aand%20other%20living%20things.)
- Srivastav, S., Chandrakar, R., Gupta, S., Babhulkar, V., Agrawal, S., Jaiswal, A., Prasad, R., & Wanjari, M. B. (2023). ChatGPT in Radiology: The Advantages and Limitations of Artificial Intelligence for Medical Imaging Diagnosis. *Cureus*, 15(7), e41435. <https://doi.org/10.7759/cureus.41435>

## **Homecoming of Refugee Children by Maryam Ali**

The refugee crisis is a prevalent and challenging global issue growing slowly. Although many countries are doing their best to provide for refugees, refugees still face daunting challenges. Without emotional, financial, and community support, mental health conditions become arduous, especially for children. From having a basic shelter to migrating to a safer environment, every step of their journey has detrimental effects on their mental health. The life after refugee children move from their home country to their host country is most crucial and of great significance. Numerous aspects including social interaction, education, assimilating to the host country's culture, and language barriers, have adverse impacts on refugee children's mental health and well-being.

Recent studies on refugee children shed new light on the hardships they face after moving into their resettlement countries, which previous studies lacked. Although this issue may seem trivial, it is crucial in today's challenge we face with ever-increasing refugees around the globe. Refugee children get displaced and face this huge change and do not have any emotional support. The primary issue arises when refugee children need to assimilate and get used to a different culture. This often leads to various mental health disorders which are preventable. For instance, "educational and recreational challenges may impose barriers to normal child development, which may socially isolate children and toddlers from their peers, limit their exposure to child-friendly environments and opportunities to play and explore, and develop their social interaction skills" (Riskalla 11). Riskalla illustrates how educational and social challenges can hinder child development and cause various mental health problems. He describes how children isolate themselves from their classmates and avoid social interaction. This concern can hinder refugee children's way of expressing themselves and growing. We need to create safe environments, introduce new programs, and bring in qualified teachers and child psychologists who can work with these children to bring them into a positive and healthier mindset. To take a case in point, a young boy named Paul from a sub-Saharan African country. He and his family arrived a year previously in Canada, having fled persecution. One day at school he fainted and then was referred to a pediatric emergency room. He fainted again and then was referred to a newcomer pediatric refugee clinic. "The pediatrician, without pushing for disclosure of pre-migratory trauma from the family, established an alliance with the parents and discovered that the boy had witnessed extremely traumatic scenes" (Measham 210). We need to focus on keeping children in a safe environment due to the trauma they have faced in their home country due to war, etc. Another example of traumatic experiences and the effect they can have is that "children also experience behavioral regression post-displacement, as Yara narrated how her son started to stutter: "My son gets scared from anything. He would say, 'Mama should I say this?' because he is scared even from normal words . . . Normal conversations" (age 21, a mother of two children)" (Riskalla 14). As shown, refugee children go through struggles even before displacement and can have a big impact on daily life. When they move to their host country, it is our responsibility to help them overcome these challenges.



An example would be that, "the UK is facing a major increase in the number of people seeking asylum each year, of whom approximately a quarter are children" (Fazel and Stein 1). As numbers of refugee children grow, it becomes increasingly difficult to assist and help them. We need to develop new strategies so that refugee children and their mental health do not get compromised. This is a wide struggle for refugee children because every aspect of life is different from where they previously lived. "Successful programs emphasize the role of cross-cultural teams who can work in an extended outreach manner. Some programs have also tried to integrate traditional healing methods to try and enhance the effectiveness of treatment. Home-based or school-based work has advantages with families who might have a lingering distrust of authority" (Fazel and Stein 2). Various approaches and methods are being implemented and brought up to work with different types of children who experienced trauma and who are trying to get used to the environment they have been brought into. However, not all treatments are valid, and do not have an elaborative study done on them. This shows us that we need to pay special attention to these challenges and issues and address them to the best of our ability. A deeper study and scientific approach is the need of the hour. Other "important aspects include special training for refugee determination officials, legal representatives, guardians, interpreters, and others who come in contact with children to understand the principles and standards of the Convention on the Rights of the Child and other international laws" (Fazel and Stein 4). Fazel and Stein argue that special training is crucial for officials and various others who are in contact with refugee children. This is because we need the people around refugee children to be culturally aware, gentle, kind, emphatic, and understanding. Officials need to know what type of tone, language, and approach is needed to handle refugee children with utmost care. If these requirements are not met, they should not interact with them.

Furthermore, the language barrier aspect is quite prevalent when it comes to refugee children. We need to have an understanding of their cerebral abilities and try to understand their way of communicating. "The practical implications are that verbal and language-based therapies need to be adapted for the particular child's intellectual and language abilities" (Hodes 721). Special therapies and various psychiatrists who are well-versed in more than one language need to be brought up when dealing with their traumas and challenges. Refugee children will be more comfortable and open to sharing their concerns, worries, and feelings better when they are talking with someone who fully understands them. Going back to Paul's story, the pediatrician who was responsible for Paul decided to direct him to a community clinic mental health team. After conducting many tests and collaborating with a child psychiatrist, an art therapist, and a school social worker, they confirmed that Paul had severe PTSD. "His parents tended to minimize their boy's symptoms because of their trauma and their need to cope well with the difficult migration process" (Measham 211). As we can see, it is best to not dig out their traumatic experiences unless and until they feel like they need to because that could lead to additional distress which can be avoided. "Preparation of the child, corroboration with agencies involved, and minimization of the child's distress by not unnecessarily going through their traumatic experiences can enhance initial engagement and build trust by listening to what is

important for them, especially unaccompanied minors” (Hodes 721). Listening not only enables refugee children to freely share their thoughts and struggles but also allows them to relieve any emotions they have bottled up or held in. Letting everything out sometimes is the biggest relief anybody can feel. I am not saying that people who do not know a certain language can't interact with refugee children, they can and words are not the only way to show how much you care for somebody. There are various ways the people around refugee children can make them happy and bring their child-like innocence back. For example, bringing them toys, clothes, their favorite desserts or candy, engaging in sports, and the ideal place for refugee children to be themselves would be schools. “Schools can be the hub of a multi-modal program ranging from helping refugee children adapt to the host society to forming links with community agencies” (Hodes 724). When dealing with refugee children, we need to pay more attention to community engagement the most. Community engagement enables refugee children to engage with various people and participate in fun activities therefore benefiting their emotional and physical well-being. “Schools provide a place to learn, facilitate the development of peer relationships, and help provide a sense of identity” ( Fazel and Stein 3). Schools act as emotional and social support as well as monitor academics and nurture one's personality and upbringing. In Paul's case, “services were finally organized through the school, where the school's psychoeducation specialist met with him weekly to provide supportive sessions using art and play expression as well as psychoeducation about anxiety, and reassurance” (Measham 211). As shown, refugee children can learn and grow if the right support system is instilled in schools around the globe. Special counselors and programs can benefit refugee children and help them become open and relaxed.

Additionally, many methods and therapies have been introduced due to the increase of mental health challenges in refugee children specifically, psychotherapy. Psychotherapy enables various methods and strategies that have been used on people from different traumas and mental health conditions. “Due to migration, loss of family, and traumatic experiences, are risk factors for the emergence of antisocial behavior, and it has been found that even refugee children who are predominantly not war-exposed are at increased risk of conduct problems in resettlement countries” (Hodes 720). Anti-social behavior is really common among refugees because of the new environment they are in. We need to help children get assimilated by providing them with education, value, and a sense of community. Many refugee children are very sensitive so gently dealing with them while educating and instilling values in them is very important. Especially with the culture and religion they come from. They are used to certain foods and beliefs therefore it is important to surround them with people who have similar backgrounds and beliefs so that they have a sense of belonging and home. In other words, changing or forcing something on somebody does not positively help them. Instead helping them get used to the environment at their own pace and willingness has a more positive impact on their wellbeing, in this case, refugee children. To take a case in point, “Simran had a good rapport with her community worker who addressed her anxiety by playing her Bollywood music and also helped her do her prayers. She used the distraction of music, reading, and prayer as avenues to reduce her anxiety”

(Measham 212). This case shows us that it's important for therapists and psychiatrists to work according to the refugee children's interests, needs, and likes. It demonstrated the importance of addressing their concerns as well as their families. These methods relieve stress, anxiety, and overall anxiousness.

In regards to the forms of therapies, there are, Measham discusses, "In a different model of collaborative care in Montreal, children and their families from any region can be referred for consultation at the specialized Cultural Consultation Clinic of McGill University, which offers psychiatric consultation at a consultation clinic focusing on immigrant adult and child mental health (212). Another form of therapy that is being used is "a specialized form of psychotherapy, Trauma-Focused Cognitive Behavioral Therapy (TF-CBT), which is considered a first-line treatment for PTSD in children and adolescents in the general population and has also been promoted for refugee children and adolescents"(Measham 210). This form of therapy is being widely used and an updated form has been introduced as well but it has not been properly tested out yet. Many programs and universities have done a good job of instilling programs for refugee children. However, there are not many institutions that do this and this is not enough awareness about refugee children and their struggles. I am not saying what we are doing is not positive but rather we should be raising awareness and voice the concerns and struggles refugee children face.

To summarize and conclude, as the number of refugee children increases, our resources for treating and helping refugee children should increase as well. Many children face harsh conditions and go through various ordeals after and before migration. They struggle with education, language barriers, mental health conditions, assimilation, and more. Working together with pediatricians, therapists, and school counselors will help refugee children assimilate and get familiar with the various changes around them. It is our job to raise a voice for the difficulties they face and help them to live a good life. As various authors and writers have illustrated their concerns, we need to step up and join organizations, donate, and volunteer to the best of our ability to help refugee children around the globe.

### Works Cited

- Fazel, M., and A. Stein. "The mental health of refugee children. (Review)." *Archives of Disease in Childhood*, vol. 87, no. 5, Nov. 2002, pp. 366+. *Gale OneFile: High School Edition*, link.gale.com/apps/doc/A94206475/STOM?u=j043914&sid=bookmark-STOM&xid=ee180fa0. Accessed 26 Feb. 2024.
- Hodes, Matthew, and Panos Vostanis. "Practitioner Review: Mental Health Problems of Refugee Children and Adolescents and Their Management." *Journal of Child Psychology and Psychiatry*, vol. 60, no. 7, 2019, pp. 716–731, <https://doi.org/10.1111/jcpp.13002>.
- Measham, Toby, et al. "Refugee Children and Their Families: Supporting Psychological Well-Being and Positive Adaptation Following Migration." *Current Problems in Pediatric and Adolescent Health Care*, vol. 44, no. 7, 2014, pp. 208–215, <https://doi.org/10.1016/j.cppeds.2014.03.005>.
- Rizkalla, Niveen, et al. "'Children Are Not Children Anymore; They Are a Lost Generation': Adverse Physical and Mental Health Consequences on Syrian Refugee Children." *International Journal of Environmental Research and Public Health*, vol. 17, no. 22, 2020, <https://doi.org/10.3390/ijerph17228378>.
- Scharpf, Florian, et al. "A Systematic Review of Socio-Ecological Factors Contributing to Risk and Protection of the Mental Health of Refugee Children and Adolescents." *Clinical Psychology Review*, vol. 83, 2021, <https://doi.org/10.1016/j.cpr.2020.101930>.

## **Exploring Prenatal Factors Linked to Autism Spectrum Disorder By Mila Sonkin**

### **Abstract**

Autism spectrum disorder is caused by a variety of determinants. This study focuses on how the mother's exposure to pesticides, ozone pollution, and infections, as well as the mother's pre-existing disorders, including diabetes and preeclampsia, result in the development of autism spectrum disorder in the child. It also examines the role that maternal immune activation and autoantibodies have on the risk of ASD in the mother's offspring. In addition, it analyzes specific circumstances during childbirth, which include maternal hemorrhage and the use of forceps, and addresses their potential impacts on the risk of autism in the child. Lastly, this study describes the association between incorrect brain development and ASD. Along with compiling the several different maternal circumstances during pregnancy that could cause autism, this study also mentions the link between early brain overgrowth and ASD. Essentially, it clears up any confusion about specific conjectures regarding possible maternal factors that contribute to autism spectrum disorder by presenting the data in a clear and organized manner.

### **Introduction**

According to the Centers for Disease Control & Prevention (CDC), autism spectrum disorder (ASD) is a developmental disability that can cause significant social, behavioral, and communication challenges. Autism has become increasingly common over the past one hundred years with the latest CDC report stating that 1 in 36 children is diagnosed with ASD. Furthermore, there has been a great amount of research on the potential causes of autism, identifying a multitude of cause and effect relationships and associations between autism spectrum disorder and possible contributing factors. Although correlation doesn't equal causation, finding a correlation between two things is a crucial first step to proving a causal relationship.

### **Mother's Exposure During Pregnancy**

One factor that can contribute to the development of autism in a child is the mother's exposure to specific substances during pregnancy.

### **Pesticides**

A recent article published on the relationship between prenatal and infant exposure to ambient pesticides and the prevalence of autism spectrum disorder found that exposure to pesticides was a factor that contributed to autism spectrum disorder in the child. As stated by the primary author, Ehrenstein, the "risk of autism spectrum disorder increases with prenatal and infant exposure to several common ambient pesticides that have been shown to affect neurodevelopment in experimental studies." Therefore, a pregnant woman being in the vicinity of pesticides is a cause of the development of autism in the child.

## **Ozone Pollution**

Based on a meta-analysis from Harvard T.H. Chan School of Public Health, exposure to fine particulate air pollution (PM<sub>2.5</sub>) increased the risk of autism spectrum disorder by 31% during pregnancy, with the highest risk being found during the third trimester (Harvard T.H. Chan School of Public Health). Likewise, in a study entitled “Early Life Exposure to Air Pollution and Autism Spectrum Disorder: Findings from a Multisite Case-Control Study,” the researchers determined that ozone exposure during a mother’s third trimester of pregnancy was linked with the development of autism spectrum disorder in the child (McGuinn).

## **Maternal Infections**

Additionally, there are many possible circumstances where the gestational environment can cause issues in the development of the child. To start, the mother getting specific infections during pregnancy can contribute to autism spectrum disorder in the baby. According to the study “The Role of the Immune System in Autism Spectrum Disorder,” infections, including rubella or influenza virus, “can create an inflammatory immune environment and spur the production of maternal cytokines.” According to Atladóttir, “maternal influenza infection was associated with a twofold increased risk of infantile autism.” In addition, many other studies show the link between influenza and autism spectrum disorder. Not only is the placenta likely affected, but also the infection “may cross the placenta and enter the fetal compartment to have lasting effects on the development of the fetus.” Ultimately, rubella leads to infants with congenital defects. If the mother gets rubella, it is very likely that the child will develop congenital rubella syndrome (CRS). Consequently, multiple studies, including one done by Chess S entitled “Autism in children with congenital rubella,” have shown that rubella is linked to autism spectrum disorder. In addition to rubella and influenza, a study done by Deykin and MacMahon titled “Viral Exposure and Autism” proposes that measles and mumps are linked to autism.

Moreover, bacterial infections in the mother are also connected to the development of autism spectrum disorder in the child. According to the study “Maternal Infection during Pregnancy and Autism Spectrum Disorders,” “maternal bacterial infections during pregnancy, during the second trimester and the third trimester were associated with moderately increased ASD risk.” The same study emphasizes that although there is a link between bacterial infections and autism spectrum disorder, there is no association between any maternal infection during pregnancy and ASD (Zerbo). In short, the maternal response to certain infections can lead to autism spectrum disorder in the child. Therefore, when there is an infection in the gestational environment, we should examine how the mother reacts to it.

## **Maternal Immune Activation**

Furthermore, the development of the child can also be impacted by maternal immune activation, most commonly caused by maternal viral infection (Massrali). According to Meltzer and Van de Water, “a generalized inflammatory response or loss of immune regulation” in the mother can contribute to a child having autism spectrum disorder. Maternal immune activation is

triggered by the activation of inflammatory pathways, which increases “levels of cytokines and chemokines that cross the placental and blood-brain barriers altering fetal neural development” (Massrali). Additionally, as stated by Massrali, several studies “have confirmed the link between maternal infections, the role of abnormal levels of cytokines, and the possibility of developmental anomalies in the offspring.” Additionally, a design involving pregnant rodents experiencing direct infection, specifically influenza, or the dsRNA mini poly shows substantial alterations in behavior and neurodevelopment in the progeny (Meltzer and Van de Water). Thus, activation of the maternal immune system during fetal development can certainly impact the development of the child and cause autism spectrum disorder. Huh, an associate professor of immunology at Harvard Medical School, explained how the link between a neurodevelopmental disorder, like autism spectrum disorder, and a dysregulated immune system is likely because the individuals “were exposed to this increase in inflammation during pregnancy” as stated by a study done by Harvard Stem Cell Institute titled *Gut-Brain Connection in Autism*.

### **Maternal Autoantibodies**

There have been several studies that examined and proved a link between autoantibodies in pregnant mothers and autism spectrum disorder. One particular study led by Zimmerman analyzed samples from eleven mothers with autistic children between the ages of two and eighteen. Subsequently, the researchers found serum reactivity to those proteins in the mothers who had autistic children and found no serum reactivity to those proteins in the mothers who acted as controls. However, considering the fact that this study had an extremely small sample size, its result is not enough to draw accurate conclusions. As a result, researchers executed a study with sixty-one mothers of autistic children and one hundred and two mothers who acted as a control group. In the end, they discovered that 37 and 73 kDa bands were present in 12% of samples from mothers who have children on the spectrum. On the other hand, they found that none of the mothers who served as the controls showed both bands. Therefore, the study determined that the two bands were undoubtedly more common among mothers who had children with autism. Despite the adequate number of participants, this study is also not sufficient alone to draw a valid conclusion (Meltzer and Van de Water).

In addition, a further study with a larger sample size aimed to offer additional support for the hypothesis that there is a connection between autism spectrum disorder and maternal autoantibodies. In short, the researchers identified a link between ASD behavior in the child and anti-fetal brain antibodies in the mother. They found that brain reactivity to the 37 and 73 kDa bands “correlated with lower expressive language,” and this result was later determined by other studies as well (Meltzer and Van de Water).

Furthermore, research has been done by Braunschweig to establish a connection between maternal autoantibodies and autism. In the study, an RFB homogenate was divided into exactly one hundred ten fractions by molecular mass. The target regions of the proteins were 30-40 kDa, 39-50 kDa, and 60-85 kDa, and they meticulously examined the fractions that contained these on separate pairs of two-dimensional gels. The researchers then took one of the two-dimensional

gels from each pair, relocated them to nitrocellulose, and lastly probed them with “diluted maternal plasma from a mother of a child with ASD who displayed reactivity to the bands in the region of interest” (Braunschweig). Subsequently, the observed spots on the two-dimensional western blots went through mass spectrometric analysis to identify developmentally regulated proteins in the fetal brain. From each spot, the protein with the highest confidence was further verified by western blot analysis. As stated by Braunschweig, “maternal IgG reactivity to LDH (37 kDa band), YBX1 (39 kDa band), STIP1 (upper 73 kDa band) and CRMP1 (lower 70 kDa band) or cypin, (a 44-kDa protein not noted in our initial studies) was observed in more than 75% of mothers of children with ASD.” Overall, this study certainly advanced the ongoing research on the correlation between maternal autoantibodies and autism spectrum disorder (Braunschweig).

Additionally, a study done by Dudova explains how a potential factor that may contribute to the development of ASD is the “presence of maternal autoantibodies targeting fetal brain proteins.” In the study, a considerable number of mothers who have children on the spectrum have maternal autoantibodies that destroy crucial fetal brain proteins that regulate normal brain development. Particularly, the targeting of collapsin response mediator proteins (CRMP1 and CRMP2), which regulate “neuron polarization, growth, guidance, and synapse refinement during the embryonic and early postnatal development of the nervous system,” could lead to “defects in axon growth/guidance, cortical migration, or dendritic projection” by changing CRMP levels or allocation in the nervous system (Dudova).

### **Maternal Diabetes & Preeclampsia**

Several studies have linked diabetes and types of hypertension, including preeclampsia, in the mother with the development of autism spectrum disorder in the child. To start, according to the Centers for Disease Control and Prevention, gestational diabetes affects two to ten percent of pregnancies in the United States every year. Considering this substantial report of diabetes during pregnancy, several studies have been conducted to determine a relationship between gestational diabetes in the mother and autism spectrum disorder in the child. At Kaiser Permanente Southern California, researchers investigated the records of approximately 322,000 mothers to discover why about three thousand four hundred of their children were autistic. They made sure to account for the other possible contributing factors to the diagnosis of autism spectrum disorder in the children since they were specifically exploring the effect of diabetes on the risk of developing ASD. Gestational diabetes typically develops during a woman’s 24th and 28th week of pregnancy. They observed that mothers who had gestational diabetes within twenty-six weeks of becoming pregnant were roughly 42% more likely to have a child with autism than women without gestational diabetes. In essence, based on this study, gestational diabetes increases the risk of having a child who is on the spectrum by about 0.5%. Additionally, the Boston Birth Cohort Study tested 2,734 children, including 102 who have autism spectrum disorder, from a minority population in Boston, Massachusetts. They ultimately determined that



mothers who were obese and had diabetes before pregnancy were approximately three to four times more likely to have a child who is on the spectrum (Sarris).

Furthermore, a high blood pressure or hypertension disorder that can happen during pregnancy is preeclampsia. As stated by Ellis, “preeclampsia typically occurs during middle to late pregnancy and up to 6 weeks after delivery, though it can sometimes appear earlier than 20 weeks.” In a study from the University of California, Davis’ MIND Institute published in *JAMA Pediatrics*, the researchers discovered that children on the spectrum were more than twice as likely to be born to mothers who had preeclampsia. Ultimately, this discovery proposes a connection between autism spectrum disorder and maternal preeclampsia during pregnancy (Ellis). Additionally, based on a meta-analysis of ten studies conducted in the USA, Canada, Australia, Denmark, Finland, and Sweden, the risk of autism spectrum disorder was 32% higher in children “who had intrauterine exposure to pre-eclampsia compared with those not exposed” (Dachew). However, another study reports that there is a 50% higher risk of ASD in children whose mothers had preeclampsia after examining sixty-one reports on the connection between types of high blood pressure and developmental conditions (Zeliadt). In essence, these two studies with different sample sizes had results that varied to a small degree. However, they still proved the same thing: an association between autism spectrum disorder and maternal preeclampsia.

### **Circumstances During Childbirth Forceps**

At times, during the second stage of delivery, the mother is not able to push the baby out of the birth canal and is in need of extra assistance. Consequently, in conjunction with contractions, doctors will use forceps, metal instruments used in order to aid in the process of delivering the baby. One important thing to note is that doctors only use forceps if the hospital can perform a cesarean section (Raynes & Lawn).

Furthermore, some severe risks come with the use of forceps for both the mother and the baby. Specifically, due to the pressure on the baby’s head from the forceps, the baby has an increased risk of having skull fractures, minor external eye trauma, seizures, minor facial injuries, nerve injuries, facial palsy, and bleeding within the skull. Often, nerve damage resolves itself and facial muscles will go back to normal, but there is still a risk that the baby develops “more severe issues, such as cerebral palsy” (Raynes & Lawn). Cerebral palsy from the use of forceps is not only common but it is also extremely severe, affecting “the movement, balance, and muscle tone of the baby.” A baby can develop cerebral palsy from an injury to the brain during or after birth; in roughly ten percent of cases, brain damage to the baby is due to the use of forceps (Raynes & Lawn). As stated by The Villari Firm, “the Autism and Developmental Disabilities Monitoring (ADDM) Network found that children with cerebral palsy may be up to 7 times more likely to have co-occurring ASD.” Therefore, there is an indirect association between the use of forceps and autism spectrum disorder in the child.

## **Maternal Hemorrhage**

Moreover, antepartum hemorrhage is when there is bleeding from the genital tract during the second half of pregnancy (Giordano). Similarly, postpartum hemorrhage is when there is bleeding from the genital tract after labor. There are a lot of different perspectives about whether maternal hemorrhage causes ASD. One study states that maternal antepartum hemorrhage during the third trimester decreased the risk of autism spectrum disorder, suggesting that it does not cause ASD (Grivas). Likewise, in the Neonatal Brain Hemorrhage Study, researchers examined the brains of over one thousand newborns weighing between 1.1 pounds and 4.4 pounds using cranial ultrasounds and determined that hemorrhages don't increase the risk of ASD. On the other hand, according to a study titled "Prenatal, Perinatal, and Postnatal Factors Associated with Autism," the researchers determined that both antepartum hemorrhage and postpartum hemorrhage were contributing factors to autism spectrum disorder (Wang). Therefore, there is still a lot of research that needs to be done about this possible association between ASD and hemorrhage, but for now, we can't make any conclusions.

## **Child Development After Birth: Incorrect Brain Development**

As stated by *First Things First*, "From birth to age 5, a child's brain develops more than at any other time in life." Therefore, after birth, poor development of the child, specifically the child's brain, can increase the risk of autism. For instance, if the "frontal cortex of the baby's brain overgrows" momentarily after being birthed, there is a chance that the child can develop ASD (Miller)." Similarly, in a study called "Early Brain Overgrowth in Autism Associated with an Increase in Cortical Surface Area Before Age 2," the researchers observed enlargement of the cerebral cortex surface area in children who are on the spectrum (Hazlett). According to Zarbalis, about 20% of children on the spectrum "have early brain overgrowth," which highlights that incorrect brain development is quite common in children with ASD.

## **Discussion**

In summary, one thing that can be certain is that specific instances during pregnancy and after birth can alter the development of the child and potentially cause autism spectrum disorder. Research has been done that has indicated the following to be associated with ASD: pesticides, ozone pollution, maternal infections, maternal immune activation, maternal autoantibodies, maternal diabetes, maternal preeclampsia, the use of forceps, maternal hemorrhage, and incorrect brain development.

However, there is a lot of research that still needs to be done in order to draw valid conclusions for some of these connections. Particularly, there is controversy about whether maternal hemorrhage causes autism spectrum disorder in the child, and there is a demand for more research on that association. Additionally, we can conclude that there is a link between maternal autoantibodies and ASD because of the results of several clinical studies and animal models. However, the exact mechanism of how maternal autoantibodies caused the development of ASD is unclear so there is additional research that needs to be done to determine this process.

Furthermore, further research is necessary to determine the effects of both maternal preeclampsia and gestational diabetes on the child to confirm the results previous studies have found which is that they are associated with the development of autism spectrum disorder. In the same way, studies have suggested an association between the use of forceps and cerebral palsy and other studies have determined a link between cerebral palsy and ASD, but there is not enough evidence yet to confirm that the use of forceps is a direct cause of autism spectrum disorder in the child.

Furthermore, despite the fact that there are different perspectives on whether pesticides are the only way to manage pests and disease carriers, there is a multitude of evidence suggesting that exposure to pesticides is harmful to human health and can potentially cause autism spectrum disorder in a child if their mother was regularly exposed to it during pregnancy. Additionally, there is a sufficient amount of evidence to support the association between maternal exposure to ozone pollution during pregnancy and the development of autism spectrum disorder in the child but there is still more research that can be done to further confirm this link. Furthermore, there are several replicable and transparent studies that suggest a connection between maternal infections and ASD in the child, but as expected, there are also a few unclear studies that state there isn't an association between maternal infections and autism spectrum disorder. In addition, there is a considerable amount of studies done on the relationship between maternal immune activation and ASD and the relationship between maternal autoantibodies and ASD, which suggests that there are strong associations between those variables and autism spectrum disorder.

## **Conclusion**

Overall, the mother's exposure during pregnancy can certainly cause changes in the development of the child. Studies have shown that maternal exposure to pesticides, as well as ozone pollution, is linked with autism spectrum disorder. In addition, during pregnancy, the gestational environment is very vulnerable to infections which could possibly lead to the child being diagnosed with ASD. Not to mention, maternal immune activation, commonly caused by infections, has strong evidence supporting its association with autism. Additionally, there have been several studies done on the link between maternal autoantibodies and ASD, one determining a possible solution to maternal autoantibody-related autism spectrum disorder: the elimination of specific pathological maternal autoantibodies. Moreover, an adequate amount of investigations have shown that maternal preeclampsia, gestational diabetes, and maternal hemorrhage are associated with ASD, but further research is essential in order to deduce their links. Similarly, the use of forceps and autism spectrum disorder are indirectly related, suggesting that there is more necessary research that must be done in order to affirm this connection. Lastly, the short period after birth is a crucial time when specific instances can occur that alter the development of the baby. One of which is early brain overgrowth, which studies have proven to be linked with ASD. In conclusion, the stretch during pregnancy leading up to the birth, during the birth, and after the birth are vital stages where certain circumstances can alter the development of the child. Therefore, we must be conscious of the various factors during

pregnancy that are linked with autism spectrum disorder so that we can do everything we can to avoid the child being diagnosed with that life-long disorder.

## Works Cited

- “Air Pollution Linked with Increased Risk of Autism in Children.” *Harvard T.H. Chan School of Public Health*, 10 May 2021, <https://www.hsph.harvard.edu/news/hsph-in-the-news/air-pollution-linked-with-increased-risk-of-autism-in-children/>.
- “Brain Development.” *First Things First*, <https://www.firstthingsfirst.org/early-childhood-matters/brain-development/>.
- Braunschweig, D., et al. “Autism-Specific Maternal Autoantibodies Recognize Critical Proteins in Developing Brain.” *Translational Psychiatry*, vol. 3, no. 7, July 2013, pp. e277–e277. *www.nature.com*, <https://doi.org/10.1038/tp.2013.50>.
- CDC. “Autism Spectrum Disorder (ASD) | CDC.” *Centers for Disease Control and Prevention*, 2 Aug. 2023, <https://www.cdc.gov/ncbddd/autism/index.html>.
- CDC. “Gestational Diabetes.” *Centers for Disease Control and Prevention*, 2 Mar. 2022, <https://www.cdc.gov/diabetes/basics/gestational.html>.
- Chess, S. “Autism in Children with Congenital Rubella.” *Journal of Autism and Childhood Schizophrenia*, vol. 1, no. 1, 1971, pp. 33–47. *PubMed*, <https://doi.org/10.1007/BF01537741>.
- Dachew, Berihun Assefa, et al. “Pre-Eclampsia and the Risk of Autism-Spectrum Disorder in Offspring: Meta-Analysis.” *The British Journal of Psychiatry*, vol. 212, no. 3, Mar. 2018, pp. 142–47. *Cambridge University Press*, <https://doi.org/10.1192/bjp.2017.27>.
- Deykin, E. Y., and MacMahon, B.. “Viral Exposure and Autism.” *American Journal of Epidemiology*, vol. 109, no. 6, June 1979, pp. 628–38. *PubMed*, <https://doi.org/10.1093/oxfordjournals.aje.a112726>.
- Dudova, Iva, et al. “Can Maternal Autoantibodies Play an Etiological Role in ASD Development?” *Neuropsychiatric Disease and Treatment*, vol. 16, June 2020, pp. 1391–98. *PubMed Central*, <https://doi.org/10.2147/NDT.S239504>.
- Ehrenstein, Ondine S. von, et al. “Prenatal and Infant Exposure to Ambient Pesticides and Autism Spectrum Disorder in Children: Population Based Case-Control Study.” *BMJ*, Mar. 2019, p. 1962. *DOI.org (Crossref)*, <https://doi.org/10.1136/bmj.1962>.
- Ellis, Marie. *Preeclampsia during Pregnancy and Child’s Autism Risk Linked*. 9 Dec. 2014, <https://www.medicalnewstoday.com/articles/286712>.
- Geggel, Laura. “Brain Damage in Premature Newborns May Raise Risk for Autism.” *Spectrum | Autism Research News*, 1 Apr. 2013, <https://www.spectrumnews.org/news/brain-damage-in-premature-newborns-may-raise-risk-for-autism/>.
- Giordano, Rosalba, et al. “Antepartum Haemorrhage.” *Journal of Prenatal Medicine*, vol. 4, no. 1, 2010, pp. 12–16. *PubMed Central*, <https://www.ncbi.nlm.nih.gov/pmc/articles/PMC3263934/>.
- Grivas, Genevieve, et al. “Pregnant Mothers’ Medical Claims and Associated Risk of Their

- Children Being Diagnosed with Autism Spectrum Disorder.” *Journal of Personalized Medicine*, vol. 11, no. 10, Sept. 2021, p. 950. *PubMed Central*, <https://doi.org/10.3390/jpm11100950>.
- Gut-Brain Connection in Autism. 7 Jan. 2022, <https://hsci.harvard.edu/news/gut-brain-connection-autism>. Hazlett, Heather Cody, et al.
- “Early Brain Overgrowth in Autism Associated with an Increase in Cortical Surface Area Before Age 2.” *Archives of General Psychiatry*, vol. 68, no. 5, May 2011, pp. 467–76. *PubMed Central*, <https://doi.org/10.1001/archgenpsychiatry.2011.39>.
- McGuinn, Laura A., et al. “Early Life Exposure to Air Pollution and Autism Spectrum Disorder: Findings from a Multisite Case-Control Study.” *Epidemiology (Cambridge, Mass.)*, vol. 31, no. 1, Jan. 2020, pp. 103–14. *PubMed*, <https://doi.org/10.1097/EDE.0000000000001109>.
- Raynes & Lawn. “What Are the LONG TERM Side Effects of Forceps Delivery? | Raynes & Lawn.” *Raynes & Lawn Trial Lawyers*, 17 Apr. 2020, <https://rayneslaw.com/what-are-the-long-term-side-effects-of-forceps-delivery/>.
- Sarris, Marina. *Mothers’ Diabetes Linked to Risk of Autism*. 10 Oct. 2016, <https://www.kennedykrieger.org/stories/interactive-autism-network-ian/mothers-diabetes-linked-risk-autism>.
- The Villari Firm. “Can Birth Injury Cause Autism? Here’s How the Two Are Linked.” *The Villari Firm*, 4 Nov. 2020, <https://www.thevillarifirm.com/2020/11/can-birth-injury-cause-autism-here-s-how-the-two/>.
- Massrali, Aïcha, et al. “Virus-Induced Maternal Immune Activation as an Environmental Factor in the Etiology of Autism and Schizophrenia.” *Frontiers in Neuroscience*, vol. 16, 2022. *Frontiers*, <https://www.frontiersin.org/articles/10.3389/fnins.2022.834058>.
- Meltzer, Amory, and Van de Water, Judy. “The Role of the Immune System in Autism Spectrum Disorder.” *Neuropsychopharmacology*, vol. 42, no. 1, Jan. 2017, pp. 284–98. *PubMed Central*, <https://doi.org/10.1038/npp.2016.158>.
- Miller, Gia. “What Causes Autism? How Genes and Environment Might Contribute.” *Psych Central*, 31 Mar. 2021, <https://psychcentral.com/autism/what-causes-autism>.
- Wang, Chengzhong, et al. “Prenatal, Perinatal, and Postnatal Factors Associated with Autism.” *Medicine*, vol. 96, no. 18, May 2017, p. e6696. *PubMed Central*, <https://doi.org/10.1097/MD.0000000000006696>.
- Zarbalis, Konstantinos. “Big Brains May Hold Clues to Origins of Autism.” *Spectrum | Autism Research News*, 23 Feb. 2016, <https://www.spectrumnews.org/opinion/viewpoint/big-brains-may-hold-clues-to-origins-of-autism/>.
- Zeliadt, Nicholette. “Study Ties Autism to Maternal High Blood

Pressure, Diabetes.” *Scientific American*, 20 July 2018,  
<https://www.scientificamerican.com/article/study-ties-autism-to-maternal-high-blood-pressure-diabetes/>.

Zerbo, Ousseny, et al. “Maternal Infection during Pregnancy and Autism Spectrum Disorders.” *Journal of Autism and Developmental Disorders*, vol. 45, no. 12, Dec. 2015, pp. 4015–25. *PubMed Central*, <https://doi.org/10.1007/s10803-013-2016-3>.

## **Colonialism's Lasting Legacy in Trinidad and Senegal By Vivaan Alleyne**

### **Abstract**

Colonialism has been a turning point in the histories of many nations, fundamentally altering their trajectories and leaving permanent marks on their societies. This paper delves into the colonial experiences of Trinidad and Senegal, exploring their pre-colonial eras, colonial experiences, and the enduring legacies of these periods including how the imposition of foreign rule has shaped their cultural, social, and economic landscapes. By exploring the pre-colonial heritage, the tumultuous periods of colonization, and the subsequent struggles for independence, this paper uncovers colonialism's profound and lasting effects on these two nations. Though often concealed beneath the surface of modern developments, the legacies of colonial rule continue to influence Trinidad and Senegal today in various ways, from their political institutions to their cultural identities. Trinidad and Senegal were chosen to illustrate how colonization, despite occurring in different geographical and historical contexts and under different colonial powers, creates enduring impacts on societies. Their colonial histories reveal parallel strategies of control, including the imposition of foreign education systems, labor exploitation, and racial hierarchies, resulting in enduring social and economic challenges. In addition to reviewing historical papers, articles, and research, this paper examines two case studies: Ousmane Sembène's films on post-colonial Senegal and Frances-Anne Solomon's portrayal of Ulric Cross's journey from Trinidad to Africa. These case studies reveal the complex relationship between colonial history and modern-day nation-building. This paper concludes that the colonial legacies in Trinidad and Senegal continue to shape their contemporary societies, presenting ongoing challenges and influencing their paths toward sustainable development and self-identity.

### **Historical Overview**

Initially settled by the Archaic people, Trinidad saw a succession of indigenous tribes before Spanish colonization. The Saladoid, Barrancoid, Arauquinoid, Guayabitoid, and finally, the Mayoid cultures, each introduced new cultural elements over the centuries, contributing to a dynamic and multicultural prehistory (Kerrigan 19). These tribes, speaking Arawakan, Cariban, and Waraoan languages, had a rich heritage with artifacts lasting until 1800 (Reid 36-37; Kerrigan 26). They organized themselves into semi-independent, egalitarian communities, indicating a lack of rigid hierarchies within both family and community structures, often forming alliances that transcended tribal lines, thus facilitating a fluid exchange of cultural practices and beliefs (Kellogg 34; Kerrigan 24). Education was informal, embedded in daily life, and intertwined with cultural norms, where knowledge and skills were passed down through generations via storytelling and participation in community activities (Kerrigan 25). Religion was deeply influenced by South American cosmology, characterized by a polytheistic and animistic belief system. This system encompassed a rich pantheon of nature-related spirits and emphasized the cyclical nature of life and death, reflecting a spiritual tradition that connected the people closely with their environment and ancestral spirits (Reid 38). Economically, tribes relied



on agriculture, hunting, and trade, with diets and skills adapted to their environment (Kerrigan 22). The Saladoids were particularly known for their pottery and farming techniques, indicative of the tribes' diverse skills and ecological adjustments (23). In pre-colonial Trinidad, trade was a vital aspect of life, facilitated by the indigenous peoples' adeptness in canoe-building and navigation, which enabled extensive interactions across the Caribbean and with the South American mainland. These interactions led to the exchange of goods such as pottery, agricultural products, and raw materials, alongside cultural ideas and practices. This robust network not only supported local economies but also contributed to the rich tapestry of cultural and ethnic diversity in the region, creating a pre-colonial society marked by intense cultural contact and exchange, far from the isolated or homogeneous communities often portrayed in traditional narratives (Kerrigan 21).

Senegal's pre-colonial era is marked by migrations and the rise of diverse cultures and kingdoms, such as the Wolof, Fulani, and Tukolor peoples. These groups were significantly influenced by the powerful Ghana, Mali, and Songhai empires, which facilitated the development of complex social structures and the establishment of significant kingdoms in the region. Arab-Berber traders first introduced Islam between the 8th and 9th centuries, profoundly shaping the region's cultural and political landscape. The Almoravids furthered this influence in the 11th century by promoting Islam, leading to the formation of Islamic states and brotherhoods that played a pivotal role in the region's history, leaving a lasting cultural and religious impact (Norris 1). The Stone Circles of Senegambia, which date from the 3rd century BC to the 16th century AD, stand as significant archeological and cultural markers. These megalithic sites are recognized by UNESCO as World Heritage Sites and underscore the region's early sophisticated religious rites and social systems. These circles were likely used in rituals related to communal well-being and the cyclical nature of life, indicating a deeply spiritual community. Political systems in pre-colonial Senegal were predominantly monarchical. Kings and local leaders, known as "Mansa" in some ethnic groups, were central figures in ensuring justice, defense, and diplomacy. They played crucial roles in managing their kingdoms' affairs, often advised by councils of elders or seasoned warriors, depending on the region and period (Foltz 145). Economically, Senegal was vibrant and diverse. The economy included agriculture, pastoralism, fishing, mining, and crafts, which were integral to daily survival and prosperity. Notably, Senegal was part of extensive regional and trans-Saharan trade networks. Trade in gold, salt, ivory, and enslaved individuals not only connected it to markets in North Africa, the Mediterranean, and across the Atlantic but also facilitated the further spread of Islam and the growth of urban centers, transforming Senegal into a bustling hub of cultural exchange and economic activity (Maiga 20). Society in Senegal was stratified, reflecting the complex interaction between various influences across the region. The social hierarchy included nobles, free citizens, artisans, and enslaved people. Gender roles were clearly defined, with men typically engaged in farming and herding while women managed domestic tasks and child-rearing. This division of labor ensured the efficient functioning of households and supported the larger social order. Women in many

communities also played a crucial role in the informal economy, engaged in trade, food processing, and pottery, contributing significantly to the local markets (Dunbar 137).

The rich and dynamic pre-colonial histories of Trinidad and Senegal set the stage for understanding the profound impacts of their colonial encounters. Both regions, with their complex social hierarchies, vibrant economies, and rich cultural tapestries, experienced significant disruptions and transformations under colonial rule. The imposition of foreign powers not only altered their existing structures but also left indelible marks that continue to influence their modern identities and socio-economic landscapes.

#### The Turning Point: Trinidad's and Senegal's Journey Through Colonialism

A "turning point" is a moment in history where events take a significant and irreversible turn, altering the course of a nation's future. In the case of Trinidad and Senegal, their colonial experiences were turning points that fundamentally changed their societies. These experiences marked the beginning of a new era, one that saw foreign powers impose their will on the indigenous people, leading to lasting effects that continue to shape these nations today.

#### Trinidad: Echoes of Colonial Past

Trinidad was discovered by Christopher Columbus in 1498, leading to Spanish colonization (Watts et al.) The indigenous population, primarily comprising the Arawak and Carib tribes, suffered greatly from European diseases such as smallpox and influenza, to which they had no immunity. The introduction of these diseases led to a catastrophic decline in the indigenous population, decimating entire communities. In addition to the ravages of disease, the *encomienda* system imposed by the Spanish further exacerbated the plight of the indigenous people. This formal system allocated indigenous people to Spanish settlers, known as *encomenderos*, who were supposed to care for and Christianize them in exchange for their labor. However, in practice, it often resulted in severe exploitation and harsh labor conditions. Indigenous people were forced to work in agriculture and mining under brutal conditions, leading to significant mortality rates and further population decline.

By the late 18th century, Trinidad's strategic location and fertile land attracted British interest. In 1797, the British, led by Sir Ralph Abercromby, captured Trinidad from the Spanish. This transition marked the beginning of profound changes on the island. Under British rule, Trinidad transformed into a plantation economy centered primarily on sugar and, later, cacao production. The British implemented extensive changes to maximize the island's profitability. To support the burgeoning plantation economy, the British imported a significant number of enslaved Africans. This demographic shift not only altered the island's population composition but also entrenched a rigid racial hierarchy. Following the abolition of slavery in 1834, the British introduced indentured labor from primarily India and China to address labor shortages on the plantations. This influx of Indian laborers added another layer to the island's complex social fabric, creating a diverse yet stratified society. The British also imposed an education system that enforced English as the medium of instruction. This system aimed to produce a class of Trinidadian elites aligned with British interests and an intermediary class to aid colonial governance (Deonanan 472). The adoption of English as the official language became essential

for legal and administrative participation, serving as a marker of higher social status. This incentivized its adoption while simultaneously eroding local cultural practices and languages (473). The plantation economy entrenched exploitation and reinforced racial hierarchy, with Europeans at the top and African and Indian laborers at the bottom (Perry 36). This hierarchy was part of the colonial "divide and rule" policy, designed to sow division among different ethnic groups and inhibit unified resistance against colonial rule. These British policies reshaped Trinidad's society, embedding a legacy of cultural assimilation, economic exploitation, and racial stratification. The impacts of these policies persisted long after the end of colonial rule, influencing the island's post-independence social and economic structures (Xypolia 8).

### **Senegal: Shadows of Empire**

The French established a foothold in Senegal through strategic islands like Gorée, following the Portuguese, Dutch, and English. These islands were vital for controlling trade routes and integral to the Atlantic trade, including the infamous slave trade ("Island of Gorée") (Røge, 2022). Gorée Island, with its House of Slaves, stands as a stark symbol of this dark era. Enslaved Africans were forcibly brought to Gorée, enduring harsh conditions before being shipped to the New World (Barnett). Although off the mainland, the islands' activities profoundly impacted Senegal, causing population loss, social upheaval, and a shift in status favoring Europeans. These early outposts set the stage for Senegal's eventual full-scale colonization in the 19th century.

The French targeted Senegal's islands for their strategic benefits. At the same time, mainland expansion was driven by economic interests post-slavery, competition during Africa's Partition, and national pride since acquiring colonies was perceived as a symbol of a country's status as a great power (Phimister). Senegalese were employed in low-wage jobs with poor working conditions, while Europeans and the African elite occupied higher-status positions. Similarly to English education in Trinidad, French education in Senegal aimed to cultivate a French-aligned elite, also known as the "évolués," undermining local cultures and promoting French superiority. Language and education thus served as effective tools for assimilation and control. The "civilizing mission" narrative justified colonialism, establishing a racial hierarchy with French and assimilated Africans at the top.

#### **Examining Colonial Legacies in Trinidad and Senegal**

Film is a powerful medium for studying history because it depicts the daily lives and emotions of people in a realistic manner that historical texts and papers often cannot. By capturing the nuanced experiences, struggles, and aspirations of individuals, films provide a vivid and immersive understanding of historical events and their impacts on society. Through visual storytelling, films can convey the complexities of colonialism and its lingering effects on culture, identity, and social dynamics. This examination reveals layers of human experience and emotional depth that complement and enrich traditional historical research, offering unique insights into the lived realities of those affected by colonialism. By analyzing films, we can

better understand the enduring impact of colonial rule on contemporary societies, as well as the ways in which individuals and communities navigate and resist these legacies.

Ousmane Sembène, the 'father of African cinema,' effectively used film to portray the profound impacts of French colonialism in Senegal. As he stated, 'I was driven to film as a more effective tool for my activism,' understanding that film could reach and resonate with a broad audience (criterioncollection). His films *La Noire de...* (1966) and *Faat Kiné* (2000) are prime examples of this approach. *La Noire de...* marked a milestone as the first film made by a sub-Saharan African director, vividly illustrating Sembène's activist intentions. The film narrates Diouana's journey from Dakar to Antibes, where she anticipates a new life working for a French couple, only to encounter harsh realities. Her dreams of financial independence are shattered by the reality of servitude and confinement, a narrative that reveals the lingering effects of colonialism in post-colonial Senegal. This theme is immediately established in the opening scene, where Diouana, dressed in white, faces the scrutiny of an all-white, black-clad crowd, setting the tone for the power imbalances explored throughout the film..

Sembène's use of flashbacks in *La Noire de...* contrasts Diouana's initial optimism with her grim experiences, underscoring the persistent impact of colonialism. The film revisits her life in Senegal, where racial differences mirror social and economic disparities, showing the continued French influence. Diouana's job hunt in affluent white neighborhoods and the stark contrast with her impoverished home life illustrate the racial wealth gap. Her selection by a French employer, who coldly evaluates the Black women lined up for work, echoes slavery's objectification. Diouana's submissive interactions and deferential "yes, madame" responses to her employer reveal her ingrained reverence for, and fear of, white authority, highlighting the dependency and legacy of racism in post-colonial Senegal (Sembène 17:37).

Diouana's idealized view of Europe as an Eldorado full of opportunity is evident before her departure to France. She dreams of a life in Europe that seems impossible in Senegal, excitedly repeating, "to France, to France," in anticipation of experiencing European culture. A poignant scene shows Diouana and her boyfriend in Senegal, leafing through a French magazine that depicts a glamorous, sophisticated France, starkly contrasting with Senegalese reality and devoid of black faces. Despite Senegal's independence, this idealization reveals the enduring influence of French cultural dominance. However, Diouana's expectations are dashed upon her arrival to France as she finds herself restricted to her employers' home, unable to explore the life she envisioned.

Diouana's forced assimilation into French domestic life begins when Madame insists she wears a maid's uniform instead of her stylish attire, symbolizing the loss of her autonomy and the onset of her servitude. This control over Diouana's appearance indicates the lingering colonial mindset. As the film unfolds, Diouana is paraded before her employers' guests, her African identity exploited as an exotic novelty. The guests' praise of her cooking, attributed to her African heritage, and an awkward embrace from a white guest who boasts of never having "embraced a negro," underscore the racism and objectification she endures. The guests' cultural insensitivity and the employers' display of an African mask Diouana gifted them back when they

were in Senegal as a decorative item further reveal their superficial appreciation of African culture. Diouana's struggle to reclaim the mask later on symbolizes her fight for self-determination. Throughout her time in France, she remains confined to the household, her dreams of a broader European life unfulfilled, as she becomes a captive to her employers' demands, living in a state of perpetual anxiety.

Sembène's adept use of camera techniques captures Diouana's emotional state and the chasm between her and her employers without relying on dialogue. Close-ups of Diouana's face poignantly express her isolation and disillusionment in France. The visual juxtaposition of Madame and her husband's leisure in the foreground against Diouana's relegated position in the background underscores her alienation. The physical and emotional distance between Diouana and her employers in the film symbolizes the historical oppression of Senegal and the persistence of colonial superiority within personal spaces.

In France, Diouana's ordeal mirrors a modern form of enslavement, underscoring the persistent legacy of colonialism. Her employers' demeaning treatment reflects deep-seated colonial attitudes that view Africans as inferior, a continuation of the historical exploitation of Senegalese people. Diouana's expected servitude is reminiscent of past exploitation of African labor, revealing how colonial legacies continue to shape racial and economic dynamics, marginalizing African individuals in contemporary society.

In *Faat Kiné*, Sembène explores the life of a single mother and entrepreneur in late 20th-century Dakar. Kiné exemplifies resilience and independence as she manages a gas station, raises her children, and confronts societal norms in post-colonial Senegal. Though set three decades after *La Noire de...*, the film still reveals the profound influence of colonialism on African society. In *Faat Kiné*, the enduring influence of French culture in Senegal is highlighted during an episode at Kiné's gas station. A Europeanized black customer condescendingly remarks, "What a black way you have of doing business," when Kiné makes her wait. The customer's sense of superiority, derived from her European assimilation, is evident when she attempts to pay with foreign currency and later the next day when her white husband's silent presence is used to intimidate Kiné. Despite Kiné's firm stance, the incident highlights the societal clout still held by white individuals.

The subtle influence of France in post-colonial Senegal is also captured in a scene where Kiné's maid watches French TV, illustrating France's cultural hold. The dominance of French media thirty-five years after independence underscores its lasting impact. Kiné's children, much like Diouana, see limited prospects in Senegal, believing fulfillment and professional success lie in the West. Despite academic excellence, their desire to study abroad stems from a colonial legacy that has devalued local capabilities and exalted Western education. This sentiment contributes to a brain drain, as the most talented pursue opportunities in societies they deem more advanced, a testament to the deep-rooted effects of colonialism on self-perception and aspirations.

While Sembène's films provide a vivid depiction of the colonial legacy in Senegal, the exploration of colonial impacts is not limited to African contexts alone. The story of Ulric Cross,

a Trinidadian who played a significant role in African independence movements, further illustrates the global reach and enduring effects of colonialism. Frances-Anne Solomon's film, *Hero: The Extraordinary Life of Mr. Ulric Cross* (2019), shifts the focus to the Caribbean, showing how colonial education systems and military service influenced Cross's worldview and his contributions to the decolonization process in Africa.

This biopic portrays Ulric Cross, a Trinidadian Royal Air Force hero and a key figure in African independence. The film links his wartime service to his influence on Africa's political change. Shaped by British colonial education, Cross's perspectives were formed in a system designed to instill European values. A telling scene at his prestigious school, where students recite English islands in response to a teacher's question, symbolizes the colonial aim to replace local identity with European ideals. The professor asks the children, "What are the islands around England?" and they dutifully respond, "Gugh Island, Walney Island, Isle of Wight." This recitation emphasizes the colonial agenda to prioritize European geography over their own Caribbean heritage, reflecting how deeply ingrained these teachings were. Such education molded young Trinidadians, including Cross, to view the world through a European lens, fundamentally altering their self-identity and sense of belonging. This highlights the broader impact of colonial rule on shaping personal and political identities, demonstrating the lasting effects of colonial education on its subjects.

An example of how deeply this education influenced Cross's self-perception is evident during World War II, when he, serving England, confronts a military document questioning his European descent. His reply to his friend Kofi, "I'm just as European as anybody else here," reveals the deep influence of colonial culture. This episode reflects the colonial goal of assimilating colonized peoples into European mindsets, often erasing their cultural heritage. Cross's claims to European identity, despite being Trinidadian, highlight the effectiveness of colonialism in forging an elite that identified with colonial powers. This highlights the enduring and complex impact of colonialism on individual and collective identities, where European-imposed identities eclipse native ones.

Cross's claim to a European identity, while rejecting his Trinidadian roots, not only underscores the success of colonial assimilation but also sets the stage for his profound transformation. The stark contrast between his self-perception during World War II and his subsequent experiences in Africa illustrates the evolution of his identity. As Cross transitions from the battlefields of Europe to the heart of Africa, he confronts the entrenched colonial myths that shaped his early beliefs. This journey to Africa, initially fueled by a desire to contribute to independence movements, becomes a personal voyage of discovery and disillusionment. In Ghana, he realizes the falsehoods he was taught, noting, "I think after everything I've ever heard or learned about Africa, it's all a lie," and is surprised to find a world far different from the stereotypes of Africans. This revelation exposes the gap between colonial propaganda and the true nature of Africa, questioning the British narratives that aimed to elevate their culture and belittle African heritage—colonial policies in Trinidad and beyond used education and labor systems to control and redefine cultural identities. Africa's portrayal as "uncivilized" served to

justify colonial rule by asserting European superiority. Cross's awakening in Ghana symbolizes a pivotal challenge to the colonial narratives, a step towards decolonizing his own perceptions and reassessing historical misconceptions.

### Conclusion

The legacies of colonialism in Trinidad and Senegal are profound and multifaceted, shaping contemporary cultural, social, and economic landscapes in ways that are both visible and subtle. As this paper has illustrated, the enduring influence of colonial structures and ideologies continues to pose significant challenges to these nations' paths toward sustainable development and self-determination. The colonial past has not only left a mark on the institutional and educational frameworks but also continues to influence identity politics and economic strategies in both countries.

To address these enduring challenges, it is imperative for policy-makers and stakeholders in both Trinidad and Senegal to engage in comprehensive and inclusive dialogue that considers the historical contexts and their present-day implications. For Trinidad, revisiting educational curricula to include more substantial content on local and regional histories could help foster a greater sense of identity and reduce the lingering effects of cultural hegemony. Trinidad has been proactive in its educational reforms to decolonize its school curricula. The Ministry of Education has been working to include more comprehensive historical content that covers pre-colonial and colonial histories, as well as the contributions of various ethnic groups to the nation's development. This approach aims to provide a more balanced and inclusive view of history, equipping students with a better understanding of their diverse cultural heritage (London). Additionally, in Trinidad, the government has initiated various cultural preservation projects that aim to revitalize and celebrate the nation's diverse cultural heritage. For instance, the annual Emancipation Day celebration and Indian Arrival Day serve not only as reminders of the past but also as platforms for promoting African and Indian cultural heritage respectively (Noel; Sookdeo). Moreover, the government supports programs like the Prime Minister's Best Village Trophy Competition, which encourages communities to preserve and promote traditional arts, crafts, dance, and music (Prime Minister's Best). These initiatives are vital in counteracting the cultural erosion caused by colonial dominance and fostering a sense of pride and identity among citizens.

Similarly, in Senegal, promoting local languages and cultural practices in formal education could empower local identities and enhance social cohesion. The government has taken significant steps to promote local languages and cultures. One of the notable initiatives is the introduction of national languages into the formal education system. Languages such as Wolof, Pulaar, Serer, and Jola are being taught in schools, which helps in preserving these languages and promoting cultural diversity (Mc Laughlin). This policy not only aids in cultural retention but also enhances students' abilities to engage with their cultural heritage more deeply. Economically, Senegal has been investing in sectors that leverage local resources and cultural heritage, such as sustainable tourism and agriculture. Projects like the Senegal River Valley Development and the "Return to Agriculture" (Retour vers l'Agriculture) program aim to

revitalize the agricultural sector by introducing modern techniques while promoting traditional practices that are environmentally sustainable and culturally relevant (Rodembourg; Seck 6).

International collaboration and partnerships should be encouraged, not only within the regions of the Caribbean and Africa but also globally, to support these nations in overcoming colonial legacies. Such collaborations could include educational exchanges, cultural projects, and economic initiatives that recognize and respect the sovereignty and unique cultural contexts of each nation.

Through such strategic, culturally sensitive, and historically informed approaches, Trinidad and Senegal can continue to work towards healing the wounds of their colonial pasts while building paths to a more equitable and sustainable future. This requires not just national efforts but also global recognition of the impacts of colonialism and a commitment to supporting decolonization processes in various forms.



## Works Cited

- Sembène, Ousmane. (Director). (1966). *La Noire de...* [The Criterion Collection].
- Sembène, Ousmane. (Director). (2001). *Faat Kiné* [Motion Picture].
- Solomon, Frances-Anne. (Director). (2019). *Hero: The Extraordinary Life of Mr. Ulric Cross* [Capital Motion Picture Group].
- “Angela Davis on Sembene.” *The Sembene Project*, YouTube, 9 Oct. 2020. Accessed 18 Jan. 2024.  
[www.youtube.com/watch?v=SPq-y\\_m6PGE](http://www.youtube.com/watch?v=SPq-y_m6PGE).
- Barnett, Errol. “Senegal’s Scenic Island Exposes Horrors of Slave Trade.” CNN, Cable News Network, 23 Feb. 2012. Accessed 6 Dec. 2023.  
[www.cnn.com/2012/02/21/world/africa/goree-island-senegal/index.html#:~:text=Known%20as%20Senegambia%20at%20the,onto%20ships%20to%20the%20Americas](http://www.cnn.com/2012/02/21/world/africa/goree-island-senegal/index.html#:~:text=Known%20as%20Senegambia%20at%20the,onto%20ships%20to%20the%20Americas).
- Beebe, Sean. “Colonialism to Cooperation: France, Mauritania, and Senegal, 1960-1980.” ProQuest Dissertations Publishing, Aug. 2020. Accessed 6 Dec. 2023.  
<https://www.proquest.com/openview/d3ff27e1e773c8ddfb38ac3a6c4be2ef/1?pq-origsite=gscholar&cbl=18750&diss=y>.
- Boomert, Arie. *The Indigenous Peoples of Trinidad and Tobago: From the First Settlers until Today*. Sidestone Press, 2016. Accessed 2 Jan. 2024.  
[www.sidestone.com/books/the-indigenous-peoples-of-trinidad-and-tobago](http://www.sidestone.com/books/the-indigenous-peoples-of-trinidad-and-tobago).
- Britannica, The Editors of Encyclopaedia. “Encomienda.” *Encyclopedia Britannica*, 5 Sep. 2023. Accessed 11 Dec. 2023.  
[www.britannica.com/topic/encomienda](http://www.britannica.com/topic/encomienda).
- De Lisle, J. “Insights on the Marginalization of Poor Children in the Education System of Trinidad and Tobago.” *Achieving Inclusive Education in the Caribbean and Beyond From Philosophy to Praxis*, edited by S. Blackman, D. Conrad, and L. Brown, Springer International Publishing, 2019, pp. 1-17.  
<https://doi.org/10.1007/978-3-030-15769-2>.
- Deonanan, Carlton R. “Education and Imperialism.” *The Journal of Negro Education*, vol. 45, no. 4, 1976, pp. 472–78. JSTOR, Accessed 19 June 2024.  
<https://doi.org/10.2307/2966859>.
- Dunbar, Roberta Ann. *Canadian Journal of African Studies / Revue Canadienne Des Études Africaines*, vol. 29, no. 1, 1995, pp. 137–39. JSTOR, Accessed 14 Feb. 2024.  
<https://doi.org/10.2307/485789>.
- Epstein, James. “Chapter 3: Only Answerable to God and Conscience’: Justice Unbounded by Law.” *Scandal of Colonial Rule: Power and Subversion in the British Atlantic during the Age of Revolution*. Cambridge University Press, 2012.  
[www.cambridge.org/us/universitypress/subjects/history/british-history-after-1450/scandal-colonial-rule-power-and-subversion-british-atlantic-during-age-revolution?format=HB](http://www.cambridge.org/us/universitypress/subjects/history/british-history-after-1450/scandal-colonial-rule-power-and-subversion-british-atlantic-during-age-revolution?format=HB).
- Foltz, W. J. “Social Structure and Political Behavior of Senegalese Elites.” *Behavior Science Notes*, vol. 4, no. 2, 1969, pp. 145-163.

- <https://doi.org/10.1177/106939716900400202>.
- Gadjigo, Samba. "Ousmane Sembene: The Life of a Revolutionary Artist." *California Newsreel*. Accessed 13 Dec. 2023.  
[www.newsreel.org/articles/ousmanesembene.htm](http://www.newsreel.org/articles/ousmanesembene.htm).
- Hinds, David. "A Mailman to Make Government Understand: The Calypsonian (Chalkdust) as Political Opposition in the Caribbean." *Music & Politics*, vol. 4, no. 2, 2010,  
<https://doi.org/10.3998/mp.9460447.0004.204>.
- "History of Trinidad." *Milwaukee Public Museum*. Accessed 2 Jan. 2024.  
[www.mpm.edu/research-collections/anthropology/online-collections-research/east-indian-s-trinidad/history](http://www.mpm.edu/research-collections/anthropology/online-collections-research/east-indian-s-trinidad/history).
- Janis, M. "Remembering Sembène: The Grandfather of African Feminism." *College Language Association Journal*, 2008, pp. 248-264.  
<https://www.clascholars.org/assets/docs/CLAJ/CLAJ-57.4.pdf>
- Kellogg, Susan. "Pueblos within Pueblos: Tlaxilacalli Communities in Acolhuacan, Mexico, ca. 1272–1692." *Latin American Antiquity*, vol. 29, no. 4, 2018, pp. 837–839. Cambridge University Press, Accessed 14 Feb. 2024.  
<https://www.cambridge.org/core/journals/latin-american-antiquity/article/abs/pueblos-within-pueblos-tlaxilacalli-communities-in-acolhuacan-mexico-ca-12721692-benjamin-d-johnson-2018-university-press-of-colorado-boulder-xv-253-pp-6300-hardcover-isbn-9781607326908/70E03A462E665FE713F5AE1942E55C7E>.
- Kerrigan, Dylan. "Culture Contact: Trinidad 'Pre-History,' Historical Representation and Multiculturalism." *Journal of the Department of Behavioural Sciences*, vol. 1, no. 1, Mar. 2012, Accessed 23 May 2024.  
<https://journals.sta.uwi.edu/ojs/index.php/jbs/article/view/19/17>.
- London, Norrel A. "Ideology and Politics in English-Language Education in Trinidad and Tobago: The Colonial Experience and a Postcolonial Critique." *Comparative Education Review*, vol. 47, no. 3, 2003, pp. 287–320.  
<https://doi.org/10.1086/378249>.
- London, Norrel A. "Curriculum Convergence: An Ethno-Historical Investigation into Schooling in Trinidad and Tobago." *Comparative Education*, vol. 38, no. 1, 2002, pp. 53–72.  
<https://doi.org/10.1080/03050060120103856>.
- Maiga, Mahamadou. *Le bassin du fleuve Sénégal – De la traite négrière au développement sous-régional autocentré*. L'Harmattan, 1995. Accessed 7 Feb. 2024.  
[www.editions-harmattan.fr/livre-le\\_bassin\\_du\\_fleuve\\_senegal\\_de\\_la\\_traite\\_negriere\\_au\\_developpement\\_sous\\_regional\\_autocentre\\_mahamadou\\_maiga-9782738430939-2672.html](http://www.editions-harmattan.fr/livre-le_bassin_du_fleuve_senegal_de_la_traite_negriere_au_developpement_sous_regional_autocentre_mahamadou_maiga-9782738430939-2672.html).
- Mc Laughlin, Fiona. "Senegal: Language Situation." *Encyclopedia of Language & Linguistics (Second Edition)*, Elsevier, 31 Mar. 2006. Accessed 7 Apr. 2024.  
[www.sciencedirect.com/science/article/pii/B0080448542016606?via%3Dihub](http://www.sciencedirect.com/science/article/pii/B0080448542016606?via%3Dihub).

Noel, Melissa. "Why Emancipation Day in the Caribbean Is Important to the Global Black Liberation Struggle." *Essence*, 2 Aug. 2023. Accessed 12 June 2024.

[www.essence.com/news/emancipation-day-caribbean-global-black-liberation-struggle/](http://www.essence.com/news/emancipation-day-caribbean-global-black-liberation-struggle/).

Norris, H. T. "The Wind of Change in the Western Sahara." *The Geographical Journal*, vol. 130, no. 1, 1964, pp. 1–14. JSTOR, Accessed 14 Jan. 2024.

<https://doi.org/10.2307/1794260>.

"Ousmane Sembène on Cinema as Activism." *Criterioncollection*, YouTube, 8 Jan. 2019. Accessed 18 Jan. 2024.

[www.youtube.com/watch?v=u9LP4nxomnc](http://www.youtube.com/watch?v=u9LP4nxomnc).

Perry, John Allen. "A History of the East Indian Indentured Plantation Worker in Trinidad, 1845-1917." *LSU Historical Dissertations and Theses*, 1969. Accessed 13 Dec. 2023.

[www.repository.lsu.edu/gradschool\\_disstheses/1612](http://www.repository.lsu.edu/gradschool_disstheses/1612).

Phimister, I. "Empire, Imperialism and the Partition of Africa." *Gentlemanly Capitalism, Imperialism and Global History*, Palgrave Macmillan, London, 2002. Accessed 19 June 2024.

[https://doi.org/10.1057/9781403919403\\_4](https://doi.org/10.1057/9781403919403_4).

"Prime Minister's Best Village Trophy Competition." *Ministry of Sport and Community Development*, 16 Aug. 2022. Accessed 18 June 2024.

<https://mscd.gov.tt/community-development/prime-ministers-best-village-trophy-competition/>.

Reid, Basil. *Archaeology and Geoinformatics: Case Studies from the Caribbean*. University of Alabama Press, 2008. Accessed 7 Apr. 2024.

[www.proquest.com/openview/d3ff27e1e773c8ddfb38ac3a6c4be2ef/1?cbl=18750&diss=y&pq-origsite=gscholar](http://www.proquest.com/openview/d3ff27e1e773c8ddfb38ac3a6c4be2ef/1?cbl=18750&diss=y&pq-origsite=gscholar).

Reid, Basil A. "Reconstructing the Saladoid Religion of Trinidad and Tobago." *The Journal of Caribbean History*, vol. 38, 2004, pp. 243-264. Semantic Scholar, Accessed 14 Jan. 2024.

<https://www.semanticscholar.org/paper/Reconstructing-the-Saladoid-Religion-of-Trinidad-Reid/20c0d5377bb87dad60ba5a01b68ea3b07012ba19#citing-papers>.

Røge, P. "From Islands to Territorial Empire: The French Colonial Administration at Gorée and the Environmental Causes of Continental Expansion after the Seven Years War." *Coastal Studies & Society*, vol. 2, no. 2, 2023, pp. 171-195. Accessed 13 June 2024.

<https://doi.org/10.1177/26349817221138823>.

Rodembourg, Noëlle. "Strengthening Climate and Community Resilience in the Senegal River Valley." *Alliance Sahel*, 17 Apr. 2024. Accessed 1 June 2024.

[www.alliance-sahel.org/en/news/resilience-climate-senegal-river-valley/#:~:text=The%20Senegal%20River%20Valley%20Development,people%20in%20Mauritania%20and%20Senegal](http://www.alliance-sahel.org/en/news/resilience-climate-senegal-river-valley/#:~:text=The%20Senegal%20River%20Valley%20Development,people%20in%20Mauritania%20and%20Senegal).

Seck, Abdoulaye. "Fertilizer Subsidy and Agricultural Productivity in Senegal." *African Growth and Development Policy*, Apr. 2016. Accessed 19 June 2024.

[https://akademiy2063.org/publications/agrodep/EN/Working%20papers/Fertilizer%20Subsidy%20and%20Agricultural%20Productivity%20in%20Senegal\\_2016\\_ENG.pdf](https://akademiy2063.org/publications/agrodep/EN/Working%20papers/Fertilizer%20Subsidy%20and%20Agricultural%20Productivity%20in%20Senegal_2016_ENG.pdf).

Sookdeo, Shastri. "Arrival Day by Shastri Sookdeo: Essay Issue Six." *The Write Launch*, 2 May 2018. Accessed 23 May 2024.

[thewritelaunch.com/2017/09/arrival-day/](http://thewritelaunch.com/2017/09/arrival-day/).

"Stone Circles of Senegambia." *UNESCO World Heritage*. Accessed 7 Feb. 2024.

[whc.unesco.org/en/list/1226/](http://whc.unesco.org/en/list/1226/).

Watts, David, Robinson, Arthur Napoleon Raymond, and Brereton, Bridget M. "Trinidad and Tobago." *Encyclopedia Britannica*, 17 Jun. 2024. Accessed 18 June 2024.

[www.britannica.com/place/Trinidad-and-Tobago](http://www.britannica.com/place/Trinidad-and-Tobago).

Xypolia, Ilia. "Divide et Impera: Vertical and Horizontal Dimensions of British Imperialism." *Critique (Glasgow)*, vol. 44, no. 3, 2016, pp. 221–31. Accessed 19 June 2024.

<https://doi.org/10.1080/03017605.2016.1199629>.

# **Medicinal Chemistry: Past, Present, Future, and Impacts on ADHD Treatment - A Review**

## **By Lisa Jin**

### **Abstract**

Medicinal chemistry is very involved in the development of drugs to treat attention deficit hyperactivity disorder (ADHD). ADHD is one of the most common neurological disorders in children, affecting millions of children in the United States, with symptoms like lack of focus, disorganization, and forgetfulness. Using papers obtained from Google Scholar and databases like Gale Academic OneFile, this literature review provides a general overview of the history and current state of medicinal chemistry. It covers four major stages of medicinal chemistry today—target identification, target validation, lead identification, and lead optimization—and their respective technologies, as well as their applications in the treatment of ADHD. Lastly, this paper describes the impact of medicinal chemistry on health and explores potential future developments.

Keywords: Medicinal chemistry, ADHD, drug development

### **Introduction**

Developments in medical technology can lead to a future of advanced healthcare with more efficient treatments of a wide range of illnesses, as well as personalized medicine, where each pill is tailored to a patient's individual needs and personalized to their specific genes and lifestyle. Such personalization would greatly improve medical treatment by improving diagnostic accuracy, increasing treatment success, reducing healthcare costs, and promoting further research in the field (Stefanicka-Wojtas & Kurpas, 2023). Medicinal chemistry is the field that will realize this. Medicinal chemistry is a field dedicated to creating biological molecules to treat unmet medical needs, involving the manipulation of molecules to create or improve drugs. Medicinal chemists can isolate medicinal substances in nature or create new man made drug compounds (American Chemical Society, 2024). Their work in designing new compounds, optimizing their properties for efficacy and safety, and ensuring the proper interactions with biological targets, is fundamental in the development of drugs used in medical treatment. Currently, medicinal chemistry impacts over 131 million people in the United States using prescription drugs, which is more than 66 percent of all adults in the nation (Health Policy Institute, 2019).

Medicinal chemistry is also used in the treatment of attention deficit hyperactivity disorder (ADHD). Symptoms include inattentiveness, hyperactivity, and impulsivity, which usually present as a lack of focus, disorganization, and forgetfulness (Magnus, 2023). Sixty-two percent of children diagnosed with ADHD take medication for treatment (CDC, 2022), and at least 75% of people diagnosed with ADHD use pharmacotherapy.

### **History**

Chemical treatment of illness has existed for millennia. The Sumerians began using opium in 2100 BCE, and the ancient Chinese treated fevers with the Ma Huang (ephedra) herb in

3000 BCE (Holbrook & Garneau-Tsodikova, 2017). During the Renaissance, Paracelsus helped push chemistry and medicine further, and because of his discoveries and influence he is often called the 'Luther of Medicine'. Following his advice, alchemists began observing the chemical essence of medicines, leading to the use of inorganic components (like antimony) in medicine, as well as the development of an early idea of active ingredients (Sayre, 1918). Chemistry is clearly involved in medicine today, but this was not always the case. Historical bans on chemistry prohibited the use of chemical treatments in medicine, as in Renaissance France. It was not until King Louis XIV's chronic digestive problems were cured with an antimony purge that this ban was lifted (Holbrook & Garneau-Tsodikova, 2017).

Chemistry continued to advance throughout the eighteenth and nineteenth centuries. By 1870, many of chemistry's foundational theorems had been developed (Drews, 2000). A periodic table of elements had been tabulated, Avogadro's atomic hypothesis had been proven effective, and a theory of acids and bases had been developed. At the same time, pharmacology had become a well-defined scientific discipline. The combination of the two fields led to the creation of drug research.

When research on coal-tar derivatives, especially dyes, revealed biological tissues' selective affinity of dyes, Paul Ehrlich theorized about chemoreceptors (Drews, 2000). He proposed that the chemoreceptors on cancer cells, microorganisms, and parasites should be different from those on host tissue, and that these differences could be used in therapeutics. This was the creation of chemotherapy, a type of drug therapy, which later led to unparalleled achievements in medicine.

Analytical chemistry, a field involving the use of instruments to separate, process, and quantify the composition and structure of matter, and its use in isolating and purifying the active ingredients of medicinal plants, also contributed to medicine in the 19th and 20th centuries (Drews, 2000). Morphine was isolated from opium extract in 1815 and Papaverine was isolated in 1848. Alexander Fleming discovered penicillin in 1929. Further study on penicillin in 1938 demonstrated its efficacy and lack of toxicity, making it a very useful drug to fight against bacterial infections. Many other antibiotic substances-- compounds that target bacteria-- were discovered between 1939 and 1988. As new active ingredients became available, new institutions developed for interdisciplinary drug research and development, thus leading to the formation of a new industry.

The term "medicinal chemistry" was not officially defined until the end of World War II (Holbrook & Garneau-Tsodikova, 2017). Thereafter, advancements in pharmacology enabled scientists to quantitatively describe molecular biological activity via assay techniques such as IC<sub>50</sub>, the Half-maximal inhibitory concentration, which measures drug efficacy by quantifying the amount of drug needed to reduce a biological process by half (Senem Aykul & Martinez-Hackert, 2016). This quantitative leap allowed for the iterative process of manipulating small molecules and observing the resulting changes in biological activity. Such a process set the foundations for rational drug design, and evolved into the modern concept of structure-activity relationship studies.

## **Present**

Currently, there are many techniques for the four major processes of medicinal chemistry that this paper will focus on: target identification, target validation, lead identification, and lead optimization. This paper will also cover each step's involvement in developing treatments for ADHD. Currently, methylphenidate and amphetamine are the most commonly used stimulant medications (Connolly et al., 2015). However, both medications can have adverse side effects. Methylphenidate can cause insomnia, anorexia, abdominal and head pain, nausea, and irritability (Khajehpiri et al., 2014). In a study performed on 71 children diagnosed with ADHD taking methylphenidate medication, all the children developed at least one adverse reaction, with almost 75% developing anorexia, over half (57%) developing increased irritability, and nearly half (47.2%) developing insomnia. Methylphenidate's Schedule II status marks it as having "a high potential for abuse ... and may lead to severe psychological and physical dependence." (Morton & Stockton, 2000). When abused, methylphenidate has similar effects as cocaine, and prolonged use may result in delirium, paranoia, and hallucinations.

Amphetamine use in early childhood is associated with delayed growth (Berman et al., 2008), significant increases in blood pressure and heart rate (Nanda et al., 2023), headaches, confusion, dizziness, and agitation (Baig, 2018). Another common treatment is methamphetamine, and like methylphenidate, both amphetamine and methamphetamine are highly addictive stimulants. Tolerance and tachyphylaxis to amphetamine and methamphetamine occur quickly, causing patients to increase the amounts or frequency of their doses to continue chasing a high, which generally leads to severe addiction. Methamphetamine addiction causes increased heart rate, severe mood changes, loss of appetite, deterioration of gums and teeth, as well as neurological symptoms similar to those of acute schizophrenia. Such risks associated with typical ADHD medication necessitate the need for alternative ADHD treatments.

## Target Identification

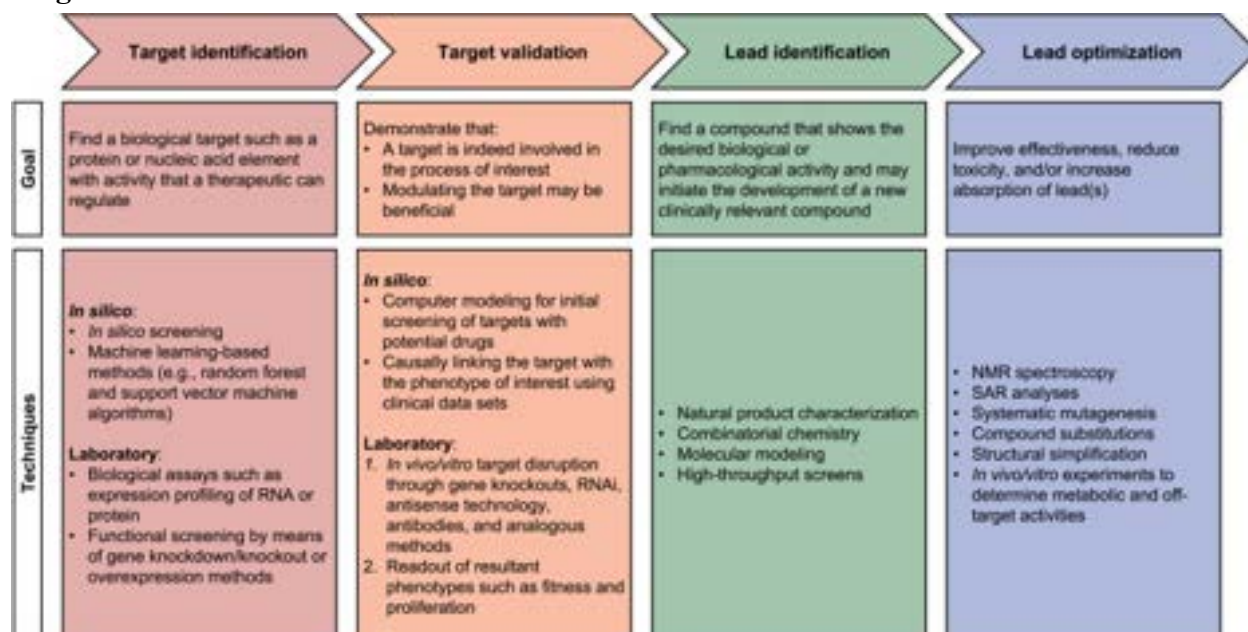

Figure 1. Overview of the four steps of drug discovery and their techniques taken from “Translational Radiation Oncology” (2023).

Target identification, the process of identifying the biological target of a molecule, is one of the most important first steps of drug discovery. (Nature, 2024). An ideal target should have a major role in the pathophysiology of a disease or be able to modify the disease, have predictable potential side effects, and be easily assayable (UCL, 2020).

Racemic amphetamine was first synthesized by chemist G. A. Alles in 1927 (Heal et al., 2013). Alles and his team first observed amphetamine’s ability to produce arousal and insomnia following experiments performed on animal and human subjects and registered it under the name Benzedrine. It was initially used to treat narcolepsy, mild depression, post-encephalitic Parkinsonism, and many other disorders. During World War II, British and American service personnel used roughly 150 million Benzedrine tablets as energy pills. Amphetamine, an appetite suppressant, was used for weight loss in obese individuals (Baig, 2018). In 1937, it was discovered that Benzedrine greatly improved the school performance and behavior of children with ADHD (Heal et al., 2013). Decades later, scientists found that the dextro-(d-) isomer of amphetamine, which was synthesized and marketed under the name Dexedrine, was significantly more effective at treating ADHD than Benzedrine. Today, amphetamine has been established as an effective treatment for ADHD and is widely used across the USA. Amphetamine was used for many different purposes and modified many times before becoming the ADHD treatment drug that it is now. This is essentially a historic example of the process of target identification.

Today, there are many pharmaceutical processes for target identification, with target-based screening and phenotypic screening being two typical ones. Target-based screening



is a method used to identify compounds that interact with specific targets (Lage, et al. 2018). The goal is to identify compounds that can modify the activity of specific molecules involved in a disease. In target-based screening, the complex that causes the disease is known, but the way it functions is unknown. There is prior knowledge of the drug, and several genomic studies are conducted before functional studies, which is why target-based screening is also called reverse pharmacology (usually functional studies are performed first). Although there is some uncertainty regarding whether the manipulation of the molecular drug target will create the desired clinical result, this can be addressed empirically. Target-based screening has led to the discovery of many new drugs. A study approved by the U.S. Food and Drug Administration on the discovery strategies for new molecules between 1999 and 2008 showed that most small-molecule drugs were discovered empirically, using target-based screening (Swinney & Lee, 2020).

In contrast, phenotypic screening is a technique in which researchers directly test molecules to see their effect on observable biological processes. Instead of focusing on the effects of a compound on a specific molecular target, phenotypic screening observes the effects on the observable characteristics. It is a target-agnostic approach to determine which active molecules cause a desired outcome (Chung, 2012). Phenotypic screening is based on the therapeutic effects of certain molecules in realistic disease models (Vincent et al., 2022). The important result of this process is that scientists can gather visible evidence of the molecule modifying or curing the illness (Pfizer, 2024). Phenotypic screens can reveal new targets because they measure cellular function without predetermined ideas about the targets or signaling pathways (Schenone et al., 2013). In fact, it has already contributed to the discovery of groundbreaking medicines for hepatitis C virus and spinal muscular atrophy (Swinney & Lee, 2020). Currently, Pfizer scientists are using phenotypic screens for cystic fibrosis, which is a genetic disease that removes the thin layer of liquid that clears mucus from lung cells, inhibiting lung function (Pfizer, 2024). The researchers use cells taken from cystic fibrosis patients to test for compounds that can re-establish this liquid. Due to the tested cells being taken from patients, there is confidence that the successful compounds will also be successful in patients. In the future, we may be able to use phenotypic screens for more complex models, including Alzheimer's and inflammatory bowel disease.

### **Target Validation**

The purpose of target validation is to demonstrate that the target is relevant to the disease of interest and that its modification can produce beneficial therapeutic results (“Translational Radiation Oncology,” 2023). Antisense technology and in vivo/in vitro assays are two methods used in target validation.

In antisense technology, antisense oligonucleotides are designed to be complementary to a region of a target mRNA molecule (Hughes et al., 2011). When the antisense oligonucleotides bind to the target mRNA, they block the mRNA from binding with the translational machinery, which prevents the encoded protein from being synthesized. Because the mRNA is being

targeted, researchers can selectively inhibit a gene's expression. By selectively silencing the target gene, researchers can validate the relation of the target molecule with the disease by observing the resulting changes in disease symptoms and development. Example use of antisense technology is the development of antisense probes to the rat P2X3 receptor by Abbott Laboratories (Honore et al., 2002). When administered, the antisense oligonucleotides revealed specific activity in the disease model, clearly showing that this receptor was related to the disease symptoms. Furthermore, receptor function and algesic responses returned after researchers stopped administering the oligonucleonucleotides, which indicates that the effects of antisense oligonucleotides can be reversed (Peet, 2003). Unfortunately, the process that creates oligonucleotides pronounces the molecules' toxicity, making it difficult to use them in vivo (Hughes et al., 2011).

In vivo and in vitro assays are another method of target validation. In vivo bioassays involve delivering the test substance to a living organism to observe the effects of the substance. An example of an in vivo assay is a brine shrimp bioassay (Encyclopedia of Biodiversity, 2024). The test substance is given to a group of brine shrimp, and the percentage of shrimp death in a short period of time is recorded. This information can be used to roughly calculate the cytotoxicity of the substance. The use of transgenic animals in in vivo assays are helpful in that they allow researchers to observe phenotypic results to better understand the results of gene manipulation (Hughes et al., 2011). In vitro assays, on the other hand, do not rely on living organisms (Encyclopedia of Biodiversity, 2024). The most common are target-specific molecular assays. In these assays, a single structure is identified, and various substances are screened to determine their effects on the step of interest. Although in vitro screening may miss important modes of action without tests on living humans, precise high-throughput in vitro bioassays have contributed to many successes, including the discovery of Zocor and the anti-inflammatory drugs based on COX-2 inhibition, like Celebrex. In vivo testing has helped in the development of new treatments for ADHD. Eltoprazine is a drug that is under development to be used in treating ADHD (Alexandrov, 2015). Using in vivo testing on a sample of adults with ADHD, researchers found that both 5-10 milligram doses significantly improve ADHD symptoms, which shows Eltoprazine's potential as an alternative treatment in the future.

## **Lead Identification**

The goal of lead identification is to find a compound with the desired pharmacological activity and potential to be developed into a new clinical compound ("Translational Radiation Oncology," 2023). High-throughput screening (HTS) and combinatorial chemistry are two techniques used in lead identification.

HTS is a process that involves screening and assaying a large number of biological compounds directly against specific targets. HTS can be used to gather metabolic, pharmacokinetic and toxicological data on new drugs (Szymański et al., 2011). It can quickly test large numbers of compounds to identify potential leads that interact desirably with the target. HTS does not use prior knowledge to pre-assume the compound that is likely to function at the

target molecule. In the HTS process, a large number of compounds are analyzed in assays that are generally used in plates of hundreds of wells (Hughes et al., 2011). HTS is able to screen hundreds of thousands of compounds with extremely small samples because of the way it combines automated robotic developments with microliter-scale reactions, which greatly improves the efficiency of the drug screening process and diversifies the possibilities of drug candidates (Holbrook & Garneau-Tsodikova, 2017). HTS can screen up to 10,000 compounds a day while Ultra HTS (UHTS) can screen up to 100,000 compounds a day (Szymański et al., 2011). HTS' efficiency and diversity is essential because parallel and combinatorial chemical synthesis can generate large numbers of new compounds (Holbrook & Garneau-Tsodikova, 2017).

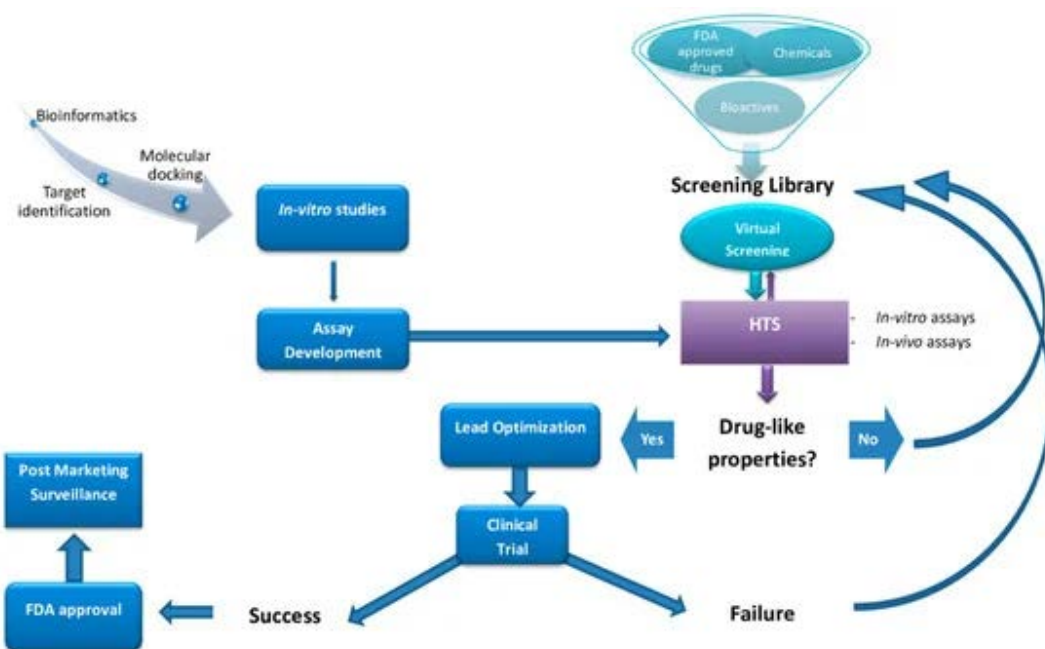

Figure 2. Flowchart showing how HTS reveals whether a compound exhibits drug-like properties, which either leads to the next stage (lead optimization) or back to the screening library. Taken from (Aldewachi et al., 2021).

Combinatorial chemistry is a method of synthesizing and testing large libraries of diverse compounds (Wess, 2001). The goal of combinatorial chemistry is to identify new compounds with desirable properties quickly and inexpensively. Instead of trial and error, combinatorial chemistry uses the idea of trial and selection. This process uses permutations of individual components to simultaneously synthesize all the possible molecules in a substance family (chemotypes). This process greatly increases variability of possible leads, as even a small number of genetic building blocks can lead to huge diversity, like that of the humoral immune response. Then, the active molecules are separated from this library with an assay and their structure is found. Combinatorial chemistry is different from traditional optimization cycles in that it follows the principle of evolution by selecting the most active compound from a group, which is similar to the concept of survival of the fittest.

HTS has also been used to gain more information about potential treatments for ADHD. For instance, using SmartCube, a high-throughput automated behavioral platform, different drugs are compared with Eltoprazine (Alexandrov, 2015). SmartCube uses computer vision and mechanical actuators to observe responses to stimuli, and is able to isolate over 2000 features of a mouse in one session. The results showed that, in multiple animals, Eltoprazine was active in hyperactivity and impulsivity, confirming its potential as a future treatment.

## **Lead Optimization**

Lead optimization is the process that involves the improvement and refinement of leads to develop more effective and less toxic drugs (“Translational Radiation Oncology,” 2023). The goal of lead optimization is to transform initial leads into optimized drug candidates. There is currently a lack of good alternative drugs for ADHD treatment. As there are no suitable leads, there are also no suitable examples of lead optimization in ADHD treatment for this paper to cover. However, there are many processes in lead optimization, with one typical process being the structure-activity relationship study.

Structure-activity relationship (SAR) studies are a major technique used in lead optimization. A SAR is the relationship between the chemical structure of a molecule and its biological activity (Structure-Activity Relationship (SAR), 2024). The goal of a SAR study is to discover the biological activity connected to a specific component of a molecule. This knowledge allows a medicinal chemist to use molecular structure in the design of new molecules and to predict biological activity. To work with SAR, one must first identify whether a SAR exists in a collection of molecules and their respective activities (Guha, 2013). If so, one or more SARs are analyzed for details, and this information is used to optimize a specific property of a molecule through structural modifications. There are many ways to analyze the data collected from SAR studies. The main idea of all of these methods is being able to systematically identify each structural difference and its respective effect on biological activity. For example, in quantitative structure-activity relationship (QSAR) methods, researchers connect numerical descriptions of structural features to molecular activity. However, these are not always accurate because the “landscape” of a SAR is not flat (Guha, 2010). Viewing chemical structure and bioactivity in a 3D view with an X, Y, and Z axis results in a landscape of varying geography (Guha, 2013). There are smooth regions, which illustrate molecules with similar structure and activity, and discontinuous regions, which illustrate molecules with similar structures but different activities. There are peaks and dips, and “activity cliffs” form when two sets of molecules with different levels of performance are close to each other. These cliffs represent discontinuities, which may hinder the performance of a QSAR, because machine learning models, by definition, cannot reliably calculate these discontinuities (Guha, 2010).

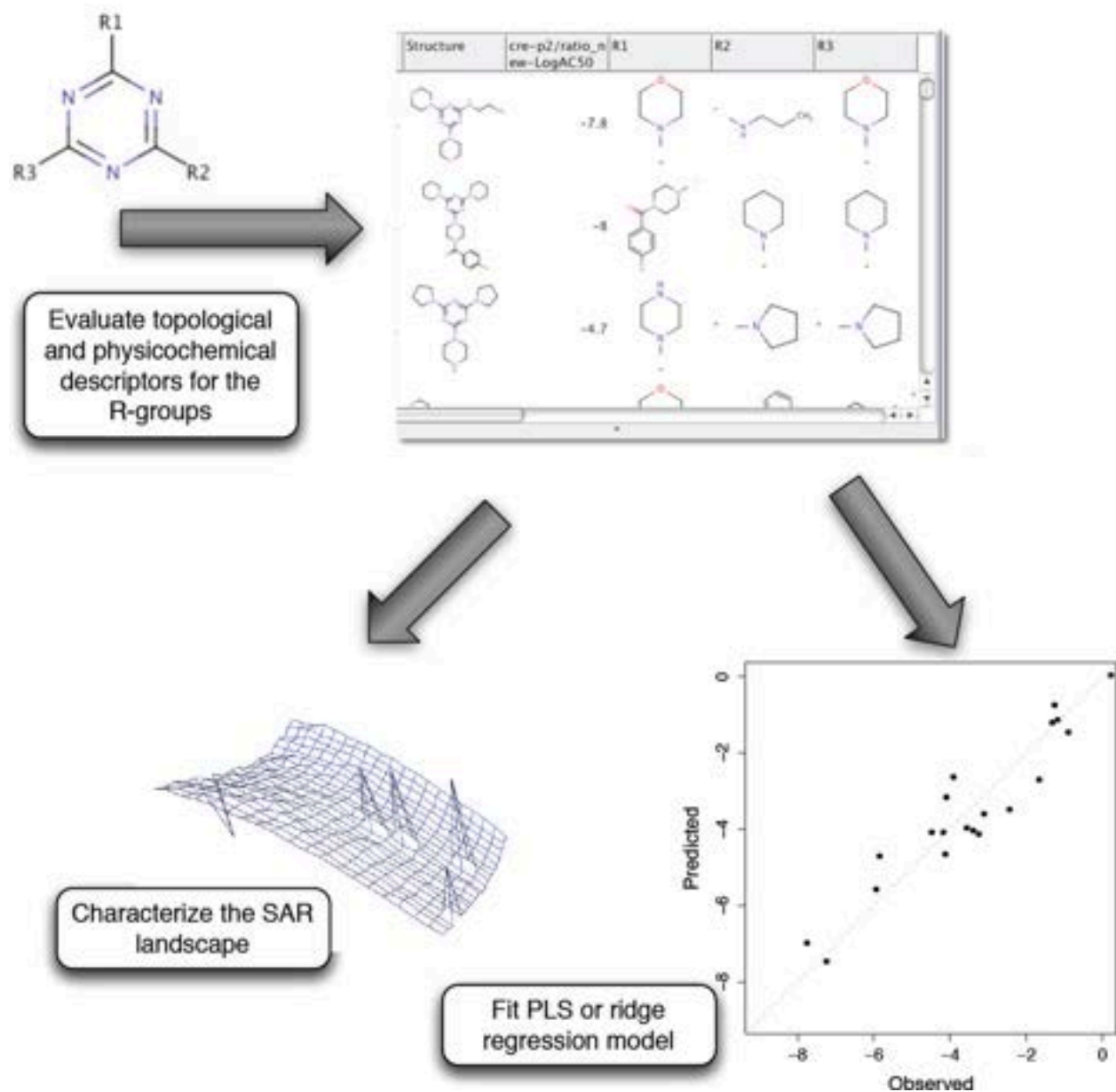

**Figure 3.** Example of a SAR landscape and its workflow taken from (Guha, 2013).

However, activity cliffs are still important to SARs, as they show the potential of a small structural change to cause a large difference in biological activity. Although QSARs do not always perform well due to the existence of activity cliffs, they are still a common method of analyzing SARs and are used extensively because they do provide important information. There are also many other methods to analyze SARs at various levels of detail, and although they are not always accurate, they can help the medicinal chemist generate new ideas (Guha, 2013). Ultimately, SAR studies are an incredibly useful mainstream technique that have consistently been used to create new therapeutic drugs (McKinney, 2000).



Figure 4. More specific steps in the drug creation process, from idea to market taken from (UCL, 2020).

## Conclusion

There will always be a need for new therapeutic drugs, whether to discover a novel treatment for an illness or to offer a safer alternative treatment for a disorder with existing treatments, like ADHD. Thus, medicinal chemistry is still important today, and will remain so in the future. Connecting many fields of science, including biochemistry, molecular chemistry, computational chemistry, and structural biology, medicinal chemistry will continue developing new technologies to better treat illnesses and advance healthcare in the future.

One possible future is expanding into personalized medicine, which takes into account each individual's genes and environment in their treatment. Current technology has shown that such personalization is necessary at some level, although there are many challenges, including the need for large data collections and efficiency in developing personalized medicines (Goetz & Schork, 2018). However, there will be many benefits if medicinal chemistry can accomplish personalization. Regardless, medicinal chemistry will continue to greatly impact drug development and medicine and the millions of people who benefit from such medicine.

## References

- Abdul Mannan Baig. (2018). DARK Side of Amphetamine and Analogues: Pharmacology, Syndromic Manifestation, and Management of Amphetamine Addiction. *ACS Chemical Neuroscience*, 9 (10), 2299-2303. <https://doi.org/10.1021/acscemneuro.8b00137>
- Aldewachi, H., Al-Zidan, R. N., Conner, M. T., & Salman, M. M. (2021). High-Throughput Screening Platforms in the Discovery of Novel Drugs for Neurodegenerative Diseases. *Bioengineering (Basel, Switzerland)*, 8(2), 30. <https://doi.org/10.3390/bioengineering8020030>
- Alexandrov, V., Brunner, D., Hanania, T., & Leahy, E. (2015). High-throughput analysis of behavior for drug discovery. *European journal of pharmacology*, 750, 82–89. <https://doi.org/10.1016/j.ejphar.2014.11.047>
- Aykul, S., & Martinez-Hackert, E. (2016). Determination of half-maximal inhibitory concentration using biosensor-based protein interaction analysis. *Analytical biochemistry*, 508, 97–103. <https://doi.org/10.1016/j.ab.2016.06.025>
- Berman, S. M., Kuczenski, R., McCracken, J. T., & London, E. D. (2009). Potential adverse effects of amphetamine treatment on brain and behavior: a review. *Molecular psychiatry*, 14(2), 123–142. <https://doi.org/10.1038/mp.2008.90>
- CDC. (2022, June 8). Data and Statistics About ADHD. Centers for Disease Control and Prevention. <https://www.cdc.gov/ncbddd/adhd/data.html>
- Chung, C. (2012). Small Molecule Bromodomain Inhibitors. *Progress in Medicinal Chemistry*, 1–55. <https://doi.org/10.1016/b978-0-12-396493-9.00001-7>
- Connolly JJ, Glessner JT, Elia J, Hakonarson H. ADHD & Pharmacotherapy: Past, Present and Future: A Review of the Changing Landscape of Drug Therapy for Attention Deficit Hyperactivity Disorder. *Ther Innov Regul Sci*. 2015 Sep;49(5):632-642. doi: 10.1177/2168479015599811. PMID: 26366330; PMCID: PMC4564067.
- Dorota Stefanicka-Wojtas, & Donata Kurpas. (2023). Personalised Medicine—Implementation to the Healthcare System in Europe (Focus Group Discussions). *Journal of Personalized Medicine*, 13(3), 380–380. <https://doi.org/10.3390/jpm13030380>
- Drews, J. (2000). Drug Discovery: A Historical Perspective. *Science*, 287(5460), 1960. [https://link.gale.com/apps/doc/A61487167/EAIM?u=nysl\\_li\\_jhsch&sid=bookmark-EAIM&xid=d7d7583a](https://link.gale.com/apps/doc/A61487167/EAIM?u=nysl_li_jhsch&sid=bookmark-EAIM&xid=d7d7583a)

- Encyclopedia of Biodiversity. (2024). ScienceDirect.  
<https://www.sciencedirect.com/referencework/9780123847201/encyclopedia-of-biodiversity>
- Goetz, L. H., & Schork, N. J. (2018). Personalized medicine: motivation, challenges, and progress. *Fertility and sterility*, 109(6), 952–963. <https://doi.org/10.1016/j.fertnstert.2018.05.006>
- Guha, R. (2010). The Ups and Downs of Structure–Activity Landscapes. *Methods in Molecular Biology*, 101–117. [https://doi.org/10.1007/978-1-60761-839-3\\_3](https://doi.org/10.1007/978-1-60761-839-3_3)
- Guha, R. (2013). On Exploring Structure–Activity Relationships. *Methods in Molecular Biology*, 81–94. [https://doi.org/10.1007/978-1-62703-342-8\\_6](https://doi.org/10.1007/978-1-62703-342-8_6)
- Heal, D. J., Smith, S. L., Gosden, J., & Nutt, D. J. (2013). Amphetamine, past and present--a pharmacological and clinical perspective. *Journal of psychopharmacology (Oxford, England)*, 27(6), 479–496. <https://doi.org/10.1177/0269881113482532>
- Holbrook, S. Y. L., & Garneau-Tsodikova, S. (2017). What is medicinal chemistry? - Demystifying a rapidly evolving discipline!. *MedChemComm*, 8(9), 1739–1741. <https://doi.org/10.1039/c7md90030a>
- Honore P, Kage K, Mikusa J, Watt AT, Johnston JF, Wyatt JR, et al. Analgesic profile of intrathecal P2X3 antisense oligonucleotide treatment in chronic inflammatory and neuropathic pain states. *Pain*. 2002;99:11–19. <https://pubmed.ncbi.nlm.nih.gov/12237180>
- Hughes, J., Rees, S., SB Kalindjian, & Philpott, K. (2011). Principles of early drug discovery. *British Journal of Pharmacology*, 162(6), 1239–1249. <https://doi.org/10.1111/j.1476-5381.2010.01127.x>
- Khajehpiri, Z., Mahmoudi-Gharaei, J., Faghihi, T., Karimzadeh, I., Khalili, H., & Mohammadi, M. (2014). Adverse reactions of Methylphenidate in children with attention deficit-hyperactivity disorder: Report from a referral center. *Journal of research in pharmacy practice*, 3(4), 130–136. <https://doi.org/10.4103/2279-042X.145389>
- Lage, Olga Maria, et al. “Current Screening Methodologies in Drug Discovery for Selected Human Diseases.” *Marine Drugs*, MDPI, 14 Aug. 2018, [www.ncbi.nlm.nih.gov/pmc/articles/PMC6117650/](http://www.ncbi.nlm.nih.gov/pmc/articles/PMC6117650/)
- Magnus, W., Nazir, S., Anilkumar, A. C., & Shaban, K. (2023). Attention Deficit Hyperactivity Disorder. In *StatPearls*. StatPearls Publishing.
- McKinney, J. D. (2000). The Practice of Structure Activity Relationships (SAR) in Toxicology.



Toxicological Sciences, 56(1), 8–17. <https://doi.org/10.1093/toxsci/56.1.8>

Medicinal Chemistry/Pharmaceuticals - American Chemical Society. (2024). American Chemical Society.  
<https://www.acs.org/careers/chemical-sciences/fields/medicinal-chemistry-pharmaceuticals.html>

Nanda, A., Janga, L. S. N., Sambe, H. G., Yasir, M., Man, R. K., Gogikar, A., & Mohammed, L. (2023). Adverse Effects of Stimulant Interventions for Attention Deficit Hyperactivity Disorder (ADHD): A Comprehensive Systematic Review. *Cureus*, 15(9), e45995.  
<https://doi.org/10.7759/cureus.45995>

Paweł Szymański, Markowicz, M., & Elżbieta Mikiciuk-Olasik. (2011). Adaptation of High-Throughput Screening in Drug Discovery—Toxicological Screening Tests. *International Journal of Molecular Sciences*, 13(1), 427–452. <https://doi.org/10.3390/ijms13010427>

Peet NP. What constitutes target validation? *Targets*. 2003;2:125–127.  
[https://scholar.google.com/scholar\\_lookup?journal=Targets&title=What+constitutes+target+validation?&author=NP+Peet&volume=2&publication\\_year=2003&pages=125-127&](https://scholar.google.com/scholar_lookup?journal=Targets&title=What+constitutes+target+validation?&author=NP+Peet&volume=2&publication_year=2003&pages=125-127&)

Prescription Drugs - Health Policy Institute. (2019, February 13). Health Policy Institute.  
<https://hpi.georgetown.edu/rxdrugs/#:~:text=More%20than%20131%20million%20people,Prescription%20drugs%20are%20costly>

Sayre, L. E. (1918). The Early History of Pharmaceutical and Medical Chemistry. *Transactions of the Kansas Academy of Science* (1903-), 29, 49–53. <https://doi.org/10.2307/3624274>

Schenone, M., Vlado Dančik, Wagner, B. K., & Clemons, P. A. (2013). Target identification and mechanism of action in chemical biology and drug discovery. *Nature Chemical Biology*, 9(4), 232–240. <https://doi.org/10.1038/nchembio.1199>

Structure-activity relationship (SAR). (2024). REVIVE.  
<https://revive.gardp.org/resource/structure-activity-relationship-sar/?cf=encyclopaedia>

Swinney, D. C., & Lee, J. A. (2020). Recent advances in phenotypic drug discovery. *F1000Research*, 9, 944–944. <https://doi.org/10.12688/f1000research.25813.1>

Target identification - Latest research and news | Nature. (2024, March 2). Nature.com; Nature.  
<https://www.nature.com/subjects/target-identification#:~:text=Target%20identification%20is%20the%20process,drug%2Fpharmaceutical%20or%20other%20xenobiotic>

That Which is Old is New Again: Phenotypic Drug Discovery Makes a Comeback | Pfizer. (2024). Pfizer.com.  
[https://www.pfizer.com/news/articles/that\\_which\\_is\\_old\\_is\\_new\\_again\\_phenotypic\\_drug\\_discovery\\_makes\\_a\\_comeback#:~:text=In%20the%20drug%20discovery%20process,specific%20driver%20of%20the%20disease](https://www.pfizer.com/news/articles/that_which_is_old_is_new_again_phenotypic_drug_discovery_makes_a_comeback#:~:text=In%20the%20drug%20discovery%20process,specific%20driver%20of%20the%20disease)

Translational Radiation Oncology. (2023). Elsevier EBooks.

<https://doi.org/10.1016/c2020-0-03217-2>

UCL. (2020, July 22). Target Identification and Validation (Small Molecules). UCL Therapeutic Innovation Networks.

<https://www.ucl.ac.uk/therapeutic-innovation-networks/target-identification-and-validation-small-molecules#:~:text=Target%20Identification%20and%20Validation%20in,experiments%20to%20show%20therapeutic%20effect>

Vincent, F., Arsenio Nueda, Lee, J., Schenone, M., Prunotto, M., & Mercola, M. (2022).

Phenotypic drug

discovery: recent successes, lessons learned and new directions. *Nature Reviews Drug Discovery*, 21(12), 899–914. <https://doi.org/10.1038/s41573-022-00472-w>

W Alexander Morton, & Stockton, G. G. (2000). Methylphenidate Abuse and Psychiatric Side Effects.

*Primary Care Companion to the Journal of Clinical Psychiatry*, 02(05), 159–164.

<https://doi.org/10.4088/pcc.v02n0502>

Wess, G., Urmann, M., & Sickenberger, B. (2001). *Medicinal Chemistry: Challenges and Opportunities*.

*Angewandte Chemie (International ed. in English)*, 40(18), 3341–3350.

# **Glutamate and GABA Neurotransmitters During an Ischemic Stroke and the Recovery Process By Jeremy Ratner**

## **Abstract**

An ischemic stroke is a devastating neurological event that can lead to significant brain injury, physical disability, cognitive impairment, and even death. During an ischemic stroke, blood flow into the brain is lost and oxygen supply to the affected area is drastically reduced. If the effects of an ischemic stroke continue without immediate intervention, cell death cannot be stopped. During an ischemic stroke, the loss of blood flow causes a critical imbalance between excitatory and inhibitory neurotransmitters. The purpose of this literature review is to analyze how glutamate, the main excitatory neurotransmitter, and GABA, the main inhibitory transmitter, change during and after an ischemic stroke. To formulate the literature review, novel experimental manuscripts and other literature reviews were considered. It was found that an ischemic stroke is especially dangerous because it causes glutamate excitotoxicity. The spike in glutamate levels creates a cycle of positive ion influx and further glutamate release. The continuous entrance of glutamate and calcium causes apoptosis, which leads to neurological damage. GABA neurotransmitters will flow into the brain to recreate the balance between the excitatory and inhibitory neurotransmitters, but GABA levels become severely elevated as a result. To experience healing, recovery, and neuroplasticity, GABA levels in the brain must be lowered so that the balance between the excitatory and inhibitory neurotransmitters can be restored.

## **Introduction**

The association between an ischemic stroke and neurotransmitter dysfunction, specifically in glutamate and  $\gamma$ -aminobutyric acid neurotransmitters, has long been examined. Ischemic strokes are the most common type of stroke, comprising 62.4% of strokes worldwide in 2019 (Tsao et al. 2023). An ischemic stroke occurs when blood vessel blockage limits blood flow to the brain. The loss of blood and oxygen to an area of the brain causes immediate physical symptoms, which can include facial numbness and weakness, impaired balance, a severe headache, visual difficulty, and nausea (Patil et. al 2022). Even if a person survives an ischemic stroke, the mortality rate for an ischemic stroke is 10% after thirty days and 40% after one year (Moraes et al. 2023). Since ischemic strokes are a significant global health issue, a stronger understanding of the molecular and physiological processes that cause ischemic strokes, and the brain's ability to heal itself afterwards, is needed to improve the path to stroke recovery. To discover the true impact of an ischemic stroke on neurological function, it is imperative to examine how neurotransmitter levels change in the brain during and after a stroke.

Neurotransmitters serve as the brain's chemical messengers, converting and transmitting signals across the postsynaptic membrane (Teleanu et al. 2022). To send chemical messages efficiently, excitatory and inhibitory neurotransmitters combine to allow for the firing and releasing of chemical signals. Excitatory neurotransmitters are postsynaptic potentials that

increase the probability of surpassing the action potential threshold, which in turn increases the likelihood that the signal is transmitted (Purves et al. 2001). The postsynaptic membrane is depolarized by excitatory neurotransmitters, stimulating diffusion. In the human nervous system, the main excitatory neurotransmitter is glutamate. When glutamate receptors are activated, channels release sodium ( $Na^+$ ) and potassium ( $K^+$ ) ions. These positively-charged ions lower the negatively-charged postsynaptic current until it exceeds the action potential threshold, causing the neuron to fire and the message to be sent. In comparison, inhibitory neurotransmitters hyperpolarize the postsynaptic membrane potential, decreasing the likelihood of diffusion and inhibiting signals from traveling between neurons (Purves et al. 2001). Gamma-aminobutyric acid (GABA) is the human brain's primary inhibitory neurotransmitter, prevalent in around 20% to 44% of neurons in the brain (Petroff 2002). When GABA receptors in the brain are activated, chlorine ( $Cl^-$ ) ions make the negative current even more negative and thus further away from the action potential threshold. There are two types of GABA receptors:  $GABA_A$  receptors, which control rapid signals through hyperpolarization, and while  $GABA_B$  receptors, which control secondary messengers (Terunuma 2018). When glutamate and GABA neurotransmitters function correctly, they can sufficiently control neuronal excitability. However, during an ischemic stroke, the balance between glutamate and GABA is disrupted. The danger of an ischemic stroke is due to glutamate excitotoxicity, a type of cell death that results from an excessive amount of glutamate released from neurons (Belov Kirdajova et al. 2020). The purpose of this literature review is to analyze how an ischemic stroke impacts the levels of glutamate and GABA in the human brain. Additionally, this literature review examines the roles of glutamate and GABA in the recovery process of an ischemic stroke, in terms of restoring neurological function and creating long-term neuroplasticity.

### **The Onset of an Ischemic Stroke**

An ischemic stroke is devastating because of its ability to suddenly cause damage to neurons. As was confirmed by Sears and Hewett, the excitatory systems and inhibitory systems create an established stability in a healthy human brain. If an interruption in the neurological balance occurs, it is impossible to maintain a level of neuronal activity that could sustain functioning. As a result, vision, communication, and movement are severely disrupted when blood flow is lost. During an ischemic stroke, the lack of equilibrium is the main contributor of neurological damage. The first step of an ischemic stroke is the loss of blood flow, which deprives the brain of oxygen and glucose. According to Kaplan-Arabaci's examination of the mechanisms that cause an ischemic stroke, adenosine triphosphate (ATP) immediately depletes without blood and glucose (Kaplan-Arabaci et al. 2022). Furthermore, there is not enough energy to continuously support brain function, meaning that regulatory processes are disrupted as well. In turn, neurons of the brain lose control over their ability to monitor brain activity.

Since neurological activity cannot be controlled, the ion pump mechanism is significantly disrupted as well. Due to a lack of ATP, cells can no longer control the number of ions entering

the synaptic cleft. Additionally, the fact that negatively-charged ATP is missing means that there is a net increase in positive charge, causing depolarization (Owen et al. 2011). The depolarization is then bolstered with an influx of positively-charged sodium ( $Na^+$ ) and potassium ( $K^+$ ) ions (Kaplan-Arabaci et al. 2022). The significant number of positively-charged ions begin the irreversible changes that makes an ischemic stroke so dangerous. During normal neurological functioning, calcium ( $Ca^{2+}$ ) ions serve as secondary transmitters that report depolarization to neurons in other areas (Gleichmann and Mattson 2011). However, this process is also ATP-dependent, specifically the ability to reuptake calcium after being released. Without proper ATP levels due to the loss of blood flow, calcium cannot be removed, causing a significant number of calcium ions to enter the synapse. In addition to the role of calcium as a secondary transmitter, calcium ions also control neurotransmitter release across the synaptic membrane (Südhof 2012). When an ischemic stroke occurs, calcium ions thus cause an abnormally high amount of glutamate to flood into the synaptic membrane.

In order to control glutamate release in the brain so that it does not descend into excitotoxicity, there are three main receptors that regulate glutamate levels: N-methyl D-aspartate (NMDA),  $\alpha$ -amino-3-hydroxy-5-methyl-4-isoxazolepropionic acid (AMPA), and kainate (Kaplan-Arabaci et al. 2022). In a recent study, Wu and Tymianski discussed the effect of NMDA pathways on ischemic strokes. When no glutamate is released, NMDA receptors are blocked by magnesium ( $Mg^{2+}$ ) ions. As a result, there is no overload of positive ions and no depolarization of the synaptic membrane. However, the activation of such a significant amount of glutamate during an ischemic stroke causes AMPA receptors to remove the magnesium ions blocking the NMDA receptors (Wu and Tymianski 2018). The positive ions cause depolarization in the synaptic membrane, and more calcium ions flow into the cell. Furthermore, the cycle of calcium causing glutamate release, and the glutamate release in turn causing more calcium release, leads to a significantly high level of calcium in the brain. With such extreme levels of calcium, the ischemic stroke has caused irreversible effects. Since the ion pumps cannot function properly, calcium is continuously pumped into the cell. The calcium alters cell shape and function because enzymes that rely on calcium to function are stimulated. Mitochondria are also damaged, and they release apoptotic signals (Belov Kirdajova et al. 2020). Even though cell death by apoptosis occurs naturally, it is triggered abnormally and detrimentally during an ischemic stroke. The widespread cell death continues because glutamate can never be removed from the synapses. As the cycle repeats itself, more and more cells die from incorrect apoptotic signals. With a significant number of dead cells, the symptoms of an ischemic stroke ensue. Therefore, it is glutamate excitotoxicity that causes serious neurological damage and even death. A flow chart of glutamate excitotoxicity is displayed in Figure 1.

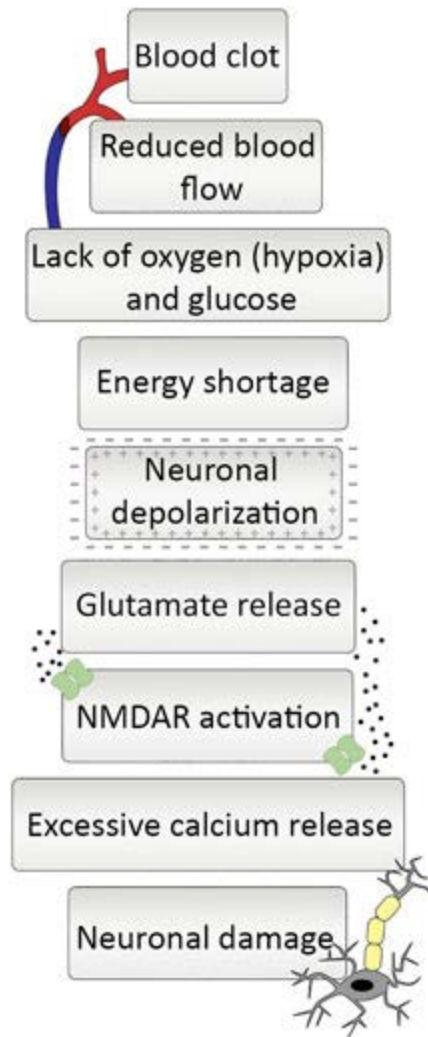

Fig 1: Beginning with the initial blood blockage, a flow chart of an ischemic stroke. (Kaplan-Arabaci et al. 2022)

During glutamate excitotoxicity, GABA neurotransmitters are completely absent from synapses because of high glutamate levels. Chlorine  $Cl^{1-}$  ions, which stimulate GABA release, are negatively charged, meaning that they are not released with an influx of positive ions. The sheer number of positively-charged ions make it impossible for GABA to be released. Since GABA is not released, there is an imbalance between glutamate and GABA in the synapse. With such an overwhelming amount of glutamate and a lack of GABA to inhibit neurological activity, glutamate levels cannot be controlled.

Directly after blood flow is lost to the brain during an ischemic stroke, the amount of glutamate is considerably higher than normal levels, while the amount of GABA is significantly lower than normal levels. In order to avoid further damage, glutamate levels must be mediated. Since GABA causes hyperpolarization of the synaptic membrane, inhibitory neurotransmitters

can counteract the excitatory glutamate neurotransmitters. As a result, GABA would be able to prohibit further excitotoxicity by inhibiting neurotransmitter release.

### **Ischemic Stroke Recovery**

GABA serves as a powerful neuroregulator after an ischemic stroke, specifically because it can counteract glutamate. Apoptosis caused by glutamate excitotoxicity is inhibited by the influx of  $GABA_A$  and  $GABA_B$  receptors (Li et al. 2020). With cell death halting, the remaining cells can stabilize themselves. Additionally, GABA allows ATP to return to normal, sustainable levels. As a result of GABA's regulatory effects and its ability to counteract glutamate, there is a significant increase in GABA neurotransmitters in the brain directly after a stroke.

As ischemic stroke victims begin recovery, the initial spike in glutamate levels has been completely removed. Since glutamate excitotoxicity has stopped, calcium flow has ceased. Instead, GABA has balanced out the glutamate levels. However, the previous glutamate levels were so high that GABA levels must also become significantly higher than stable amounts. Even though glutamate excitotoxicity caused the short-term damage of cell death, the increased GABA levels contribute to the long-term symptoms of ischemic strokes.

Since GABA levels are significantly high, the amount of GABA must be lowered to allow for long-term recovery. Decreasing GABA levels must also lead to an increase in glutamate levels, as glutamate contributes to key activity needed to restore neurological health. Glutamate also allows for long-term potentiation (LTP), which is the strengthening of neuronal connections through repeated firing of neurons (Alia et al. 2017). If the brain area affected by the ischemic stroke undergoes LTP, the damage caused by the stroke can be mitigated through neuroplasticity. In the brain, neuroplasticity is the ability to form new neural connections, which is essential for an ischemic stroke because the stroke destroyed vital neuronal connections (Kim et al. 2014). Through neuroplasticity, the brain can “rewire” itself to complete tasks in the same manner as before the stroke, often allowing for nearly complete recovery.

In the first month after a stroke, GABA uptake does not fully function. Healing from the effects of an ischemic stroke will not occur until GABA levels are lowered. There are two specific elements of GABA that must be modulated while overall GABA levels are lowered. To facilitate a deeper understanding of GABA levels, S. Thomas Carmichael examined GABA signaling in a comprehensive study on neurological recovery after an ischemic stroke. The first element of GABA and inhibition is the tonic current. GABA receptors called  $GABA_A$  receptors create and mediate a tonic current by sensing GABA neurotransmitters outside of the synapse. Tonic current controls the ability for the neuron to fire by controlling the charge of the synapse. The greater the tonic current, the more hyperpolarized the neuron, which makes the neuron less likely to fire. The lower the tonic current, the more depolarized the neuron, which makes the neuron more likely to fire (Carmichael 2012). Since GABA levels are so high approximately one month after a stroke, the tonic current is extremely high. As a result, neurons are hyperpolarized and GABA remains in the cell. To enable healing after an ischemic stroke, the tonic current must be decreased so that neurons are allowed to fire and form connections. The increase in neuronal

excitability thus allows for long-term potentiation and neuroplasticity to occur (Carmichael 2012).

Comparatively, phasic GABA, also called synaptic GABA, occurs when the synapse is depolarized and GABA is released. The depolarization of the membrane allows for neurons to fire and long-term potentiation to occur. Furthermore, an increase in phasic GABA allows for quicker recovery from an ischemic stroke (Hui et al. 2016). With GABA levels finally low enough to reach sustainable levels, neurological health has returned to a normal state (Kim et al. 2014). The roles of phasic and tonic GABA are shown in Figure 2.



Fig 2: The difference in the effects of phasic GABA and tonic GABA during ischemic stroke recovery (Hui et al. 2015).

Since decreasing tonic GABA and increasing phasic GABA allows for healing, pharmaceutical and medical treatments can be used to modulate neurotransmitter levels. New treatments are being examined that lower tonic GABA, and investigations are occurring on the effects of increasing phasic GABA. These developments would allow for more rapid recovery of physical and cognitive skills victims lost due to an ischemic stroke.

## Conclusion

The lack of neurotransmitter balance is the main factor that governs an ischemic stroke in relation to its severity, symptoms, and subsequent recovery capacity. Establishing neurotransmitter balance mitigates the effects of an ischemic stroke, but also allows for neuroplasticity and healing. Developing a greater understanding of the relationship between glutamate and GABA will allow for more effective treatment of ischemic strokes. Further research into the initial development of glutamate excitotoxicity may facilitate pharmaceutical and medical intervention that could prohibit fatality. Additionally, medication that controls and lowers GABA levels immediately after an ischemic stroke is gaining momentum, which may



allow for those suffering from the long-term effects of an ischemic stroke to improve their recovery outcomes.

## Works Cited

- Alia, Claudia, et al. "Neuroplastic Changes Following Brain Ischemia and Their Contribution to Stroke Recovery: Novel Approaches in Neurorehabilitation." *Frontiers in Cellular Neuroscience*, vol. 11, no. 76, 16 Mar. 2017, [www.frontiersin.org/articles/10.3389/fncel.2017.00076/full](http://www.frontiersin.org/articles/10.3389/fncel.2017.00076/full), <https://doi.org/10.3389/fncel.2017.00076>. Accessed 16 June 2024.
- Belov Kirdajova, Denisa, et al. "Ischemia-Triggered Glutamate Excitotoxicity from the Perspective of Glial Cells." *Frontiers in Cellular Neuroscience*, vol. 14, no. 51, 19 Mar. 2020, <https://doi.org/10.3389/fncel.2020.00051>.
- Carmichael, S. Thomas. "Brain Excitability in Stroke." *Archives of Neurology*, vol. 69, no. 2, 1 Feb. 2012, p. 161, <https://doi.org/10.1001/archneurol.2011.1175>.
- Gleichmann, Marc, and Mark P. Mattson. "Neuronal Calcium Homeostasis and Dysregulation." *Antioxidants & Redox Signaling*, vol. 14, no. 7, Apr. 2011, pp. 1261–1273, <https://doi.org/10.1089/ars.2010.3386>.
- Hiu, Takeshi, et al. "Enhanced Phasic GABA Inhibition during the Repair Phase of Stroke: A Novel Therapeutic Target." *Brain*, vol. 139, no. 2, 1 Feb. 2016, pp. 468–480, <https://doi.org/10.1093/brain/awv360>. Accessed 16 June 2024.
- Kaplan-Arabaci, Oykum, et al. "Glutamate Scavenging as a Neuroreparative Strategy in Ischemic Stroke." *Frontiers in Pharmacology*, Frontiers, 22 Mar. 2022, [www.frontiersin.org/journals/pharmacology/articles/10.3389/fphar.2022.866738/full#F1](http://www.frontiersin.org/journals/pharmacology/articles/10.3389/fphar.2022.866738/full#F1). Accessed 16 June 2024.
- Kim, Yu Kyeong, et al. "Functional Recovery after Ischemic Stroke Is Associated with Reduced GABAergic Inhibition in the Cerebral Cortex: A GABA PET Study." *Neurorehabilitation and Neural Repair*, vol. 28, no. 6, 1 July 2014, pp. 576–583, [pubmed.ncbi.nlm.nih.gov/24463186/](http://pubmed.ncbi.nlm.nih.gov/24463186/), <https://doi.org/10.1177/1545968313520411>. Accessed 16 June 2024.
- Li, Juan, et al. "The Effects of GABAergic System under Cerebral Ischemia: Spotlight on Cognitive Function." *Neural Plasticity*, vol. 2020, 28 Sept. 2020, pp. 1–9, <https://doi.org/10.1155/2020/8856722>. Accessed 16 June 2024.
- Moraes, Mariana de Almeida, et al. "Ischemic Stroke Mortality and Time for Hospital Arrival: Analysis of the First 90 Days." *Revista Da Escola de Enfermagem Da USP*, vol. 57, 2023, <https://doi.org/10.1590/1980-220x-reeusp-2022-0309en>.
- Patil, Smita, et al. *Frontiers in Medical Technology*, Frontiers, [www.frontiersin.org/articles/10.3389/fmedt.2022.748949/full](http://www.frontiersin.org/articles/10.3389/fmedt.2022.748949/full). Accessed 16 June 2024.
- Petroff, Ognen A. C. "Book Review: GABA and Glutamate in the Human Brain." *The Neuroscientist*, vol. 8, no. 6, Dec. 2002, pp. 562–573, <https://doi.org/10.1177/1073858402238515>.
- Purves, Dale, et al. "Excitatory and Inhibitory Postsynaptic Potentials." *Neuroscience. 2nd Edition*, 2001, [www.ncbi.nlm.nih.gov/books/NBK11117/#:~:text=At%20many%20other%20synapses%](http://www.ncbi.nlm.nih.gov/books/NBK11117/#:~:text=At%20many%20other%20synapses%20)

- 2C%20PSPs. Accessed 16 June 2024.
- Sears, Sheila Ms, and Sandra J. Hewett. “Influence of Glutamate and GABA Transport on Brain Excitatory/Inhibitory Balance.” *Experimental Biology and Medicine (Maywood, N.J.)*, vol. 246, no. 9, 1 May 2021, pp. 1069–1083, [pubmed.ncbi.nlm.nih.gov/33554649/](https://pubmed.ncbi.nlm.nih.gov/33554649/), <https://doi.org/10.1177/1535370221989263>. Accessed 16 June 2024.
- Sudhof, T. C. “Calcium Control of Neurotransmitter Release.” *Cold Spring Harbor Perspectives in Biology*, vol. 4, no. 1, 8 Nov. 2011, pp. a011353–a011353, <https://doi.org/10.1101/cshperspect.a011353>.
- Teleanu, Raluca Ioana, et al. “Neurotransmitters—Key Factors in Neurological and Neurodegenerative Disorders of the Central Nervous System.” *International Journal of Molecular Sciences*, vol. 23, no. 11, 25 May 2022, pp. 1–24, [www.ncbi.nlm.nih.gov/pmc/articles/PMC9180936/](https://www.ncbi.nlm.nih.gov/pmc/articles/PMC9180936/), <https://doi.org/10.3390/ijms23115954>. Accessed 16 June 2024.
- TERUNUMA, Miho. “Diversity of Structure and Function of GABA<sub>B</sub> Receptors: A Complexity of GABA<sub>B</sub>-Mediated Signaling.” *Proceedings of the Japan Academy, Series B*, vol. 94, no. 10, 11 Dec. 2018, pp. 390–411, <https://doi.org/10.2183/pjab.94.026>.
- Tsao, Connie W., et al. “Heart Disease and Stroke Statistics—2023 Update: A Report from the American Heart Association.” *Circulation*, vol. 147, no. 8, 25 Jan. 2023, [www.ahajournals.org/doi/10.1161/CIR.0000000000001123](https://www.ahajournals.org/doi/10.1161/CIR.0000000000001123), <https://doi.org/10.1161/cir.0000000000001123>. Accessed 16 June 2024.
- Wu, Qiu Jing, and Michael Tymianski. “Targeting NMDA Receptors in Stroke: New Hope in Neuroprotection.” *Molecular Brain*, vol. 11, no. 1, 13 Mar. 2018, [molecularbrain.biomedcentral.com/articles/10.1186/s13041-018-0357-8](https://molecularbrain.biomedcentral.com/articles/10.1186/s13041-018-0357-8), <https://doi.org/10.1186/s13041-018-0357-8>. Accessed 16 June 2024.

## Biological Applications of Graphene Family Nanomaterials By Eric Tam

### Abstract

The study and biological application of graphene family nanomaterials (GFNs) has grown in popularity over the past decade due to their practicality and unique properties. This article will be discussing the different types of GFNs, their unique physicochemical properties, utilities in a biological context, as well as identifying potential areas for future studies. The most frequently used GFN in biological systems is graphene oxide due to its biocompatibility. Graphene oxide, but also GFNs in general, have been successfully used in drug delivery, as cancer therapeutics, biologics delivery, and bioengineering. Specifically, GFNs have been used to bind to drugs such as SN-38, doxorubicin, camptothecin, curcumin, and 5-fluorouracil, facilitating the process of streamline delivery. They are also used in phototherapy, a type of cancer therapy, as a photothermal agent. GFNs have been found to bind to macromolecules such as siRNA and CRISPR/Cas 9 and are able to assist in biologics delivery. Lastly, GFNs are applicable to bioengineering, where biosensors and tissues are able to be synthesized. There needs to be more research done to ensure the complete safety of GFNs when introduced to the human body, as well as to improve efficacy of drug delivery and biocompatibility.

### Introduction

Nanoscience, the study of structures and particles on the nanometer scale, has been growing in awareness since the early 2000s, having a wide variety of applications in physics, materials science, chemistry, biology, computer science, and engineering (Bayda et al. 2019). Specifically, nanoscience has become a very relevant topic in the field of biology, directly applying to human health in the fields of drug delivery, cancer therapy, gene delivery, and bioengineering.

A large part of nanoscience hones in on nanoparticles, which are particles less than 100 nm large (Murthy 2007). Nanoparticles can be broken down into four categories based on their chemical composition, ranging from organic, inorganic, composite, and carbon-based. (Harish et al. 2022). Organic nanoparticles are derived from organic materials, such as polysaccharides, lipids, etc (Natesan and Kim 2022). One type of organic nanoparticle, called lipid nanoparticles, have been used to deliver a variety of therapeutics to the liver (Böttger *et al.* 2020). As of now, they have been widely optimized to deliver therapeutics to the liver, but not to other areas of the body. Inorganic nanoparticles do not contain carbon, and usually include a range of substances, such as elemental metals, metal oxides, and metal salts (Inmaculada López-Lorente and Valcárcel 2014). An application of inorganic nanoparticles are cadmium selenide quantum dots, which were the 2024 Nobel prize winner. They are currently extremely useful for biosensors, but are potentially toxic to humans (Hardman 2005). Composite nanoparticles are defined as the nanomaterials with composite structure that are made up of two or more components of nanoscale with special physical and chemical properties (Luo et al. 2014). Composite nanoparticles have a wide range of applications in gene and drug delivery, but are prone to

agglomeration and are difficult to manufacture (Hanemann and Vinga Szabó 2010). Lastly, Carbon-based nanoparticles have large carbon structures, such as fullerene, nanotubes, and graphene (Siqueira Jr. and Oliveira Jr. 2016). Carbon-based nanoparticles have the most potential for application in biology, as humans are made up of carbon, making the nanoparticles more likely to be biocompatible. Carbon-based nanoparticles are also extremely versatile, allowing for functionalization with various chemical groups (Alshangiti *et al.* 2023).

### **Graphene Family Nanomaterials**

One subsection of carbon-based nanoparticles are graphene family nanomaterials, which is the focus of this article. Nanomaterials are similar to nanoparticles, with the only condition being that nanomaterials require at least one dimension that is less than approximately 100 nanometers (“Nanomaterials” n.d.). In nature, carbon atoms form intricately bound networks that create graphite, and in some conditions, diamonds. The structure of graphite consists of multiple layers of graphene stacked on top of each other. Graphene is composed of a monolayer of carbon atoms that form a repeating hexagonal ring pattern, arranged in a planar honeycomb lattice due to the sp<sup>2</sup> hybridized properties of the carbon atom (Yusaf *et al.* 2022). The bonds holding together the carbon atoms are nonpolar, making the nanomaterials nonpolar. Due to the nonpolar properties, graphene will preferentially bind to nonpolar molecules (like certain drugs). Graphene is the precursor to other notable nanomaterials such as carbon nanotubes, fullerene, and graphene oxide.

Carbon nanotubes are formed when energy is applied to graphene that forces it into tubular structures. Some synthetic methods for creating carbon nanotubes include: electric arc discharge, laser ablation, and chemical vapor deposition (Navazi *et al.* 2023). The nanotubes are made up of rolled-up graphene sheets, where a single layer of graphene creates a single-walled carbon nanotube, while multiple layers create a multi-walled carbon nanotube (Moore, 2019). The size of carbon nanotubes typically range from 0.4 - 2 nm in diameter for single-walled carbon nanotubes and 2 - 100 nm for multi-walled carbon nanotubes (Malarkey and Parpura 2010). Functionalized carbon nanotubes have been shown to have little toxicity when entering cells (Liu *et al.* 2009). They are able to shuttle a variety of biological molecules, including small drug molecules, proteins, DNA/RNA, and other biomacromolecules (Liu *et al.* 2009). The carbon nanotubes are uptaken into the cell through endocytosis, and exit via exocytosis (Liu *et al.* 2009).

Another graphene nanomaterial derivative is fullerene. Fullerene is composed of 60, 70, or 84 carbon atoms that form a spherical shape with an average diameter of 1 nm (Budama-Kilinc *et al.* 2020). The resulting structure is a hollow sphere that resembles a soccer ball (also referred to as buckyballs). Utilizing a laser to vaporize graphite rods in an atmosphere of helium gas, chemists and their assistants were able to synthesize fullerene (Walton and Kroto 2024). Fullerene has multiple applications in biology including; protection of healthy cells against radiation when patients undergo radiotherapy, the delivery of peptides, the design of antiviral drugs, and photodynamic therapy as a cancer cell contrast agent in tumors.

The nanomaterials defined above have broad applications in material sciences, but given their nonpolar properties, become limited in utility when considering biological systems. These limitations can be circumvented by introducing polarity to these nanomaterials, by processes such as oxidation (Xu *et al.* 2018). Oxidizing graphene can produce graphene oxide, which consists of the same monolayer of carbon atoms forming a hexagonal ring pattern, but the difference is that graphene oxide contains functional groups with oxygen atoms, such as epoxide, carbonyl, carboxyl, and hydroxide (Figure 1) (Ray 2015). These functional groups serve a dual purpose; they also create reactive moieties that researchers can use to conjugate additional materials for their desired purpose (Tsagkalias and Dimitrios 2022). Some materials that have been appended to graphene oxide include amine groups, polyacrylamide (PAM), polyacrylic acid (PAA), and polyethylene glycol (PEG) (Liao *et al.* 2018). Graphene oxide nanoparticles are largely relevant in the field of biology today, with many applications to human health, specifically in drug delivery, cancer therapy, and CRISPR.

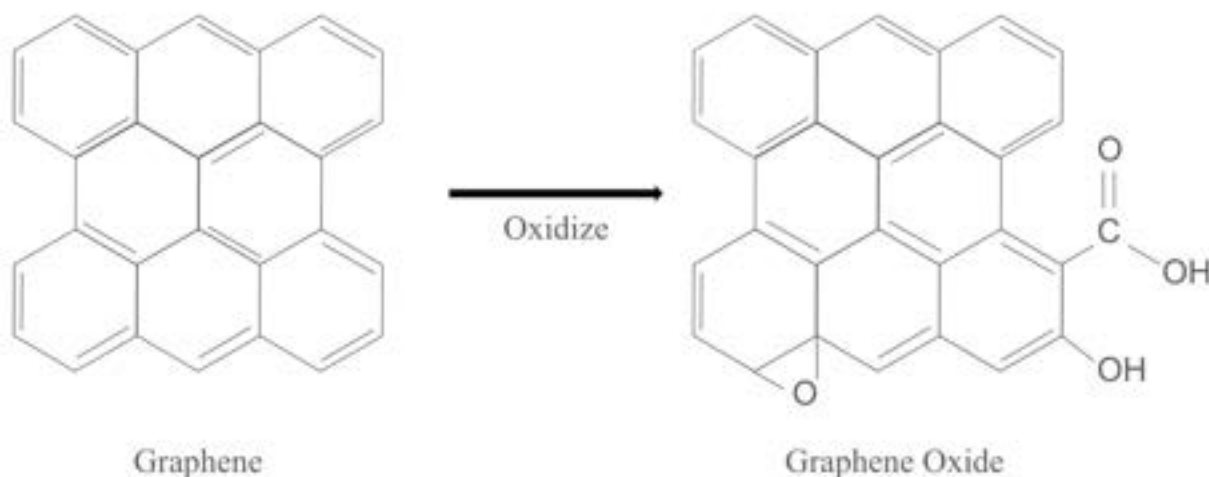

Figure 1. Different oxidation states of graphene.

### **Safety profile of Graphene Family Nanomaterials (GFNs)**

Before discussing the applications of GFNs as drug delivery vehicles, it is imperative to address safety concerns. There are some risks associated with using graphene family nanomaterials (GFNs) in biology. Previous studies have shown that non-polar GFNs have limited biocompatibility due to their propensity to aggregate and accumulate in specific tissues or cells (Ban *et al.* 2023). Furthermore, GFNs have the potential to bind lipid bilayers and to penetrate sensitive cell-cell junctions such as the blood brain barrier, the blood-testis, and blood-placenta barriers. Certain GFNs have been shown to accumulate in the spleen, kidney, and liver (Koyada and Orsu 2020). Studies have shown that the accumulation of GFNs in cells (or the extracellular matrix) can cause DNA damage, apoptosis, autophagy, necrosis, and epigenetic changes

(Lingling *et al.* 2016). These effects are highlighted when considering that GFNs were tested to accumulate in the lungs at a high level, retaining for 3 months (Ou *et al.* 2016).

Graphene nanomaterials have been demonstrated to bind to specific macromolecules, including lipids, nucleic acids, and proteins. Of concern from a safety profile is the binding of graphene nanomaterials to albumin proteins, which are proteins that regulate the transport of ligands, including bilirubin, ions, fatty acids and drugs in the body (Moman, 2022). GFNs have been demonstrated to bind to albumin proteins, with some experiments showing that GFNs have insignificant changes to the structure of the albumin protein, while others show that partial unfolding of the protein occurs (Taneva *et al.* 2021). Partial unfolding of the protein can lead to protein aggregation and cytotoxicity. In the future, it will be important to research the effects of GFNs binding to albumin proteins.

While GFNs can seem to be inherently toxic in nature, there are ways to mitigate the risks that come with utilizing GFNs. One method is through conjugation, through molecules such as PEG, PEGylated poly-L-lysine (PLL), poly( $\epsilon$ -caprolactone), polyvinyl alcohol, pluronic, amine, carboxyl, and dextran groups (Ou *et al.* 2016). Conjugating these molecules with GFNs decreases the toxicity and improves biocompatibility (Ou *et al.* 2016).

## **Biological Applications of Graphene Family Nanomaterials (GFNs)**

### **Drug Delivery**

When conjugated with biologically compatible adjuvants, GFNs become attractive drug delivery platforms due to their specific surface area and improved biocompatibility post-conjugation (Liu *et al.* 2013). There are multiple studies that have demonstrated that GFNs have a variety of biological applications including drug delivery, cancer therapy, and CRISPR. An example of a drug that has been proven to work with graphene nanoparticles is shown in a study by Liu and colleagues, where they tested the nanoparticles with the aromatic drug SN-38. SN-38 is water-insoluble, and was bound to the nanoparticles through Van der Waals interactions (Figure 2) (Liu *et al.* 2008). An interesting factor that was used in this study was polyethylene glycol (PEG), which was bound to the graphene oxide nanoparticles. This complex between the graphene oxide nanoparticles and PEG improved aqueous solubility, allowing for the water-insoluble SN-38 drug to successfully make it into the body without precipitating or being degraded by the immune system.

Another example of a hydrophobic drug that showed improved delivery with the use of GFNs is doxorubicin, a chemotherapeutic agent that intercalates with DNA. Unlike SN-38, doxorubicin contains specific functional groups that undergo protonation in acidic environments. Protonation weakens the interactions between the  $\pi$ - $\pi$  stacking and hydrophobic interactions between the doxorubicin and the graphene surface, which leads to a pH-dependent release of the drug (Zhu and Chen 2015). This pH-dependent release was also used for GFN delivery of various other drugs, such as camptothecin, curcumin, and 5-fluorouracil (Boddu *et al.* 2022). Using GFNs in these cases improved the delivery of the anticancer drugs mentioned above.

There have been multiple methods developed that have allowed researchers to release drugs from GFNs in a stimuli dependent manner (*reviewed by Khakpour et al. 2024*).

### **Cancer Therapy**

GFNs are actively used in cancer therapy, as they have a unique structure and desirable physicochemical properties. This can be seen through its ability to be covalently and noncovalently functionalized with anticancer drugs that target cancer cells and tissue (Patel et al. 2016). While chemotherapy is the most common treatment for cancer today, there are multiple drawbacks including severe side-effects, low therapeutic efficacy, multi-drug resistance, off-target effects, and more (Wang et al. 2022). Recent studies have demonstrated that graphene nanomaterials in the absence of drug molecules can themselves be used as cancer therapeutics (Wang et al. 2022).

A recent cancer therapy on the rise is phototherapy, for its therapeutic efficacy and reduced side-effects. One component of phototherapy, called photothermal therapy (PTT), relies on a photothermal agent that can adsorb laser energy and transfer it to heat under laser irradiation, resulting in local hyperthermia which can cause the death of tumor cells or bacteria (Figure 2) (Wang et al. 2022). For photothermal therapy, the efficiency of conversion is a key component, which is where GFNs come into play. Graphene nanomaterials exhibit great photothermal effect, indicating the potential as a photothermal agent for photothermal therapy (Wang et al. 2022). As GFNs prove to be promising as the agent for photothermal therapy, their use can rapidly become mainstream and result in a more effective cancer treatment.

### **Gene Delivery**

GFNs have recently been shown to be promising carriers for the delivery of DNA-based therapeutics. GFNs and DNA interact mainly through  $\pi$ - $\pi$  bonding (between sp<sup>2</sup> hybridized carbon monolayers and nucleic acids), a type of non-covalent bond (Wu et al. 2018). There are multiple types of nucleic acids that can be delivered to cells using GFNs. One example is siRNA, which stands for small interfering RNA. The main function of siRNA is to regulate the expression of genes by promoting targeted mRNA degradation for a gene of interest (Phillips 2008). Li and colleagues developed an siRNA delivery method utilizing graphene oxide nanoparticles, where the nanoparticle carriers were able to load siRNA to create a graphene oxide nanoparticle-siRNA complex. The GFN-siRNA delivery system successfully silenced the target gene in plant cells.

Another example is the delivery of plasmid DNA. Li and colleagues conducted a study that succeeded in delivering plasmid DNA to the nucleus that encoded for the CRISPR/Cas9 proteins. The CRISPR/Cas9 system works mainly through the CRISPR protein identifying the target nucleic acid sequence and Cas9 implementing the mutation. The plasmid DNA encoding for the CRISPR/Cas9 proteins was delivered by GFNs to animal cells, which was subsequently transcribed and translated, resulting in expression of functional CRISPR/Cas9 proteins that were able to mutate the target sequence (Li et al. 2023). The CRISPR/Cas9 system has been quite effective at mutating several viral genes, displaying great potential to be more effective than



antiviral drugs (Li et al. 2023). However, the transport of large Cas9 proteins requires an effective carrier, where GFNs, specifically graphene oxide nanoparticles, become a viable option.

### Bioengineering

In addition to serving as delivery vehicles for therapeutics and biologics, GFNs have also made an impact in bioengineering. Several groups have successfully characterized graphene-based biosensors capable of detecting small molecules such as glucose, nicotinamide, dinucleotide adenine, adenosine triphosphate, hydrogen peroxide, and estrogen (Dasari Shareena *et al.* 2018). Remarkably, graphene oxide based biosensors have yielded lower analyte detection limits, faster response time, higher sensitivity, and increased signal-to-noise ratios, compared to other standard biosensors (Dasari Shareena *et al.* 2018). GFNs have also seen specific applications in bioimaging (please look up which techniques are used specifically), specifically serving as a contrasting agent, but optimization is required to further enhance their utility with such techniques (Dasari Shareena *et al.* 2018). Lastly, GFNs have shown to be promising scaffolds for tissue engineering. GFNs have been used to develop lab-grown cardiac, neural, bone, cartilage, skeletal muscle and skin/adipose tissues (**Figure 2**) (Dasari Shareena *et al.* 2018).

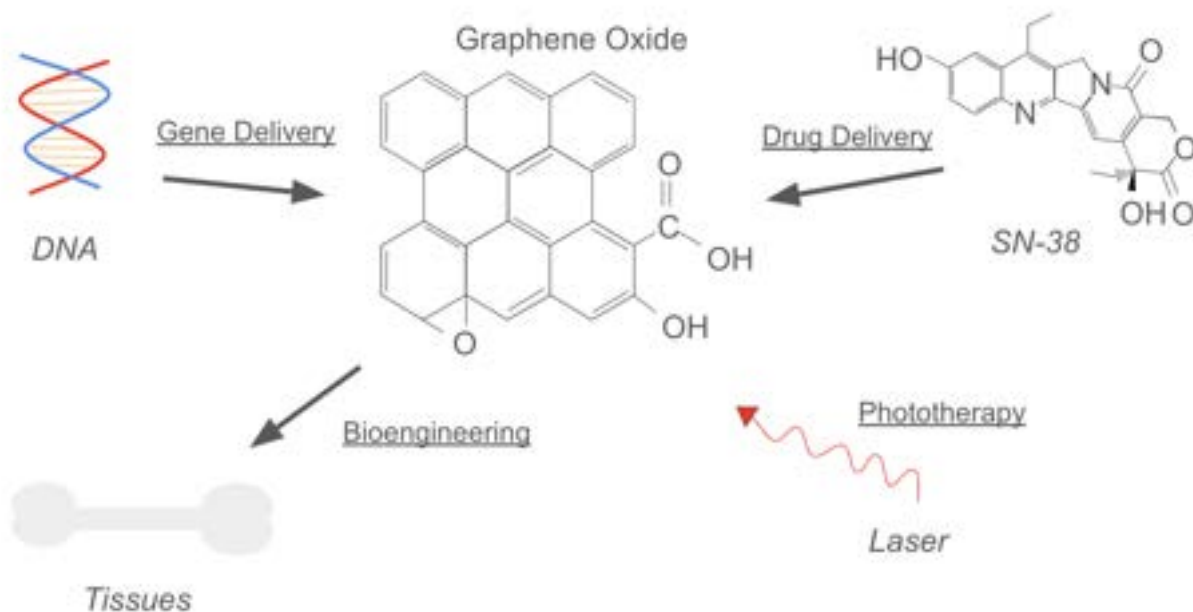

Figure 2. Various biological applications of graphene oxide including: binding to DNA and drugs (SN-38), serving as a scaffold for bioengineering applications, and an agent for phototherapy.

### Conclusion

In summary, this article summarizes the properties of graphene family nanomaterials and their biological applications. Graphene oxide has been found to be one of the most promising materials due to its polar nature, allowing it to be biocompatible in the body and used in different ways. GFNs as a whole have been proven to work with drugs, assisting in drug delivery into the body through examples such as SN-38. Additionally, GFNs have been shown to be effective at transporting nucleic acids into cells. GFNs have shown promise in cancer therapy, where it serves as a photothermal agent. Lastly, GFNs also have an impact on bioengineering, used to develop various types of tissues. GFNs, especially graphene oxide, have a lot of potential in various biological applications. Additional research should be conducted to ensure complete safety when utilizing GFNs so that they can be a new method that is better than the current ones. With GFNs, there is a great chance that drug delivery will become a more streamline process, CRISPR will become more accessible, and a more reliable cancer therapy will be fully developed.

## Works Cited

- Alshangiti, Dalal Mohamed, et al. "Revolutionizing Biomedicine: Advancements, Applications, and Prospects of Nanocomposite Macromolecular Carbohydrate-Based Hydrogel Biomaterials: A Review." *RSC Advances, U.S. National Library of Medicine*, 4 Dec. 2023, [www.ncbi.nlm.nih.gov/pmc/articles/PMC10694639/](http://www.ncbi.nlm.nih.gov/pmc/articles/PMC10694639/). Accessed 23 June 2024.
- Ban, Ge, et al. "Potential Biomedical Limitations of Graphene Nanomaterials." *International Journal of Nanomedicine, U.S. National Library of Medicine*, 30 Mar. 2023, [www.ncbi.nlm.nih.gov/pmc/articles/PMC10069520/#:~:text=Graphene%2Dfamily%20nanomaterials%20\(GFNs\),promising%20materials%20for%20biomedical%20applications](http://www.ncbi.nlm.nih.gov/pmc/articles/PMC10069520/#:~:text=Graphene%2Dfamily%20nanomaterials%20(GFNs),promising%20materials%20for%20biomedical%20applications.). Accessed 11 June 2024.
- Bayda, Samer, et al. "The History of Nanoscience and Nanotechnology: From Chemical-Physical Applications to Nanomedicine." *Molecules (Basel, Switzerland), U.S. National Library of Medicine*, 27 Dec. 2019, [www.ncbi.nlm.nih.gov/pmc/articles/PMC6982820/](http://www.ncbi.nlm.nih.gov/pmc/articles/PMC6982820/). Accessed 23 June 2024.
- Boddu, A., Obireddy, S. R., Zhang, D., Rao, K. K., and Lai, W.-F. (2022). "ROS-generating, pH-responsive and highly tunable reduced graphene oxide-embedded microbeads showing intrinsic anticancer properties and multi-drug co-delivery capacity for combination cancer therapy." *Drug Deliv.* 29, 2481–2490. doi:10.1080/10717544.2022.2100512. Accessed 17 June 2024.
- Böttger, Roland, et al. "Lipid-Based Nanoparticle Technologies for Liver Targeting." *Advanced Drug Delivery Reviews, Elsevier*, 20 June 2020, [www.sciencedirect.com/science/article/pii/S0169409X20300636](http://www.sciencedirect.com/science/article/pii/S0169409X20300636). Accessed 23 June 2024.
- Budama-Kilinc, Yasemin, et al. "Nanobiomaterials for Neural Regenerative Medicine." *Neural Regenerative Nanomedicine, Academic Press*, 18 Sept. 2020, [www.sciencedirect.com/science/article/abs/pii/B9780128202234000024](http://www.sciencedirect.com/science/article/abs/pii/B9780128202234000024). Accessed 11 June 2024.
- Dasari Shareena, Thabitha P., McShan, D., Dasmahapatra, A. K., and Tchounwou P. B. "A Review on Graphene-Based Nanomaterials in Biomedical Applications and Risks in Environment and Health." *Nano-Micro Lett.* (2018) 10:53, 21 May 2018, <https://link.springer.com/article/10.1007/s40820-018-0206-4>. Accessed 17 June 2024.
- Hanemann, Thomas, and Dorothée Vinga Szabó. "Polymer-Nanoparticle Composites: From Synthesis to Modern Applications." *Materials, MDPI*, 28 May 2010, [www.ncbi.nlm.nih.gov/pmc/articles/PMC5521756/](http://www.ncbi.nlm.nih.gov/pmc/articles/PMC5521756/). Accessed 23 June 2024.
- Hardman, Ron. "A Toxicologic Review of Quantum Dots: Toxicity Depends on Physicochemical and Environmental Factors." *Environmental Health Perspectives, U.S. National Library of Medicine*, 20 Sept. 2005, [www.ncbi.nlm.nih.gov/pmc/articles/PMC1367826/](http://www.ncbi.nlm.nih.gov/pmc/articles/PMC1367826/). Accessed 23 June 2024.
- Inmaculada López-Lorente, Ángela, and Miguel Valcárcel. "Analytical Nanoscience and

- Nanotechnology.” *Comprehensive Analytical Chemistry, Elsevier*, 25 Oct. 2014, [www.sciencedirect.com/science/article/abs/pii/B9780444632852000018](http://www.sciencedirect.com/science/article/abs/pii/B9780444632852000018). Accessed 24 May 2024.
- Koyyada, et al. “Safety and Toxicity Concerns of Graphene and Its Composites.” *Comprehensive Analytical Chemistry, Elsevier*, 16 Oct. 2020, [www.sciencedirect.com/science/article/abs/pii/S0166526X20300647#:~:text=GFNs%20have%20the%20potential%20to,spleen%2C%20liver%2C%20kidneys%20etc](http://www.sciencedirect.com/science/article/abs/pii/S0166526X20300647#:~:text=GFNs%20have%20the%20potential%20to,spleen%2C%20liver%2C%20kidneys%20etc). Accessed 03 June 2024.
- Liao, Chengzhu, et al. “Graphene Nanomaterials: Synthesis, Biocompatibility, and Cytotoxicity.” *International Journal of Molecular Sciences, U.S. National Library of Medicine*, 12 Nov. 2018, [www.ncbi.nlm.nih.gov/pmc/articles/PMC6274822/](http://www.ncbi.nlm.nih.gov/pmc/articles/PMC6274822/). Accessed 08 June 2024.
- Liu, Jingquan, et al. “Graphene and Graphene Oxide as New Nanocarriers for Drug Delivery Applications.” *Acta Biomaterialia, Elsevier*, 16 Aug. 2013, [www.sciencedirect.com/science/article/abs/pii/S174270611300408X](http://www.sciencedirect.com/science/article/abs/pii/S174270611300408X). Accessed 24 May 2024.
- Liu, Zhuang, et al. “Carbon Nanotubes in Biology and Medicine: In Vitro and in Vivo Detection, Imaging and Drug Delivery.” *Nano Research, U.S. National Library of Medicine*, 1 Feb. 2009, [www.ncbi.nlm.nih.gov/pmc/articles/PMC2824900/#:~:text=CNTs%20have%20been%20used%20to,cells%20through%20exocytosis%20%5B95%5D](http://www.ncbi.nlm.nih.gov/pmc/articles/PMC2824900/#:~:text=CNTs%20have%20been%20used%20to,cells%20through%20exocytosis%20%5B95%5D). Accessed 14 June 2024.
- Liu, Zhuang, et al. “PEGylated Nanographene Oxide for Delivery of Water-Insoluble Cancer Drugs.” *Journal of the American Chemical Society*, vol. 130, no. 33, 29 July 2008, pp. 10876–10877, doi:10.1021/ja803688x. Accessed 03 June 2024.
- Luo, Guangsheng, et al. “Composite Nanoparticles.” *Encyclopedia of Microfluidics and Nanofluidics*, 2014, pp. 1–9, doi:10.1007/978-3-642-27758-0\_243-3. Accessed 24 May 2024.
- Malarkey, Erik B, and Vladimir Parpura. “Carbon Nanotubes in Neuroscience.” *Acta Neurochirurgica, U.S. National Library of Medicine*, [www.ncbi.nlm.nih.gov/pmc/articles/PMC2908329/#:~:text=The%20size%20of%20CNTs%20typically,one%20to%20several%20hundred%20micrometers](http://www.ncbi.nlm.nih.gov/pmc/articles/PMC2908329/#:~:text=The%20size%20of%20CNTs%20typically,one%20to%20several%20hundred%20micrometers). Accessed 07 June 2024.
- Moman, Rajat N. “Physiology, Albumin.” *StatPearls [Internet]., U.S. National Library of Medicine*, 26 Dec. 2022, [www.ncbi.nlm.nih.gov/books/NBK459198/](http://www.ncbi.nlm.nih.gov/books/NBK459198/). Accessed 03 June 2024.
- Moore, Sarah. “How Are Carbon Nanotubes Made from Graphene?” *AZoNano*, 30 Aug. 2022, [www.azonano.com/article.aspx?ArticleID=5338#:~:text=The%20production%20of%20carbon%20nanotubes,which%20have%20slightly%20different%20properties](http://www.azonano.com/article.aspx?ArticleID=5338#:~:text=The%20production%20of%20carbon%20nanotubes,which%20have%20slightly%20different%20properties). Accessed 07 June 2024.
- Murthy, Shashi K. “Nanoparticles in Modern Medicine: State of the Art and Future Challenges.” *International Journal of Nanomedicine, U.S. National Library of Medicine*, [www.ncbi.nlm.nih.gov/pmc/articles/PMC2673971/](http://www.ncbi.nlm.nih.gov/pmc/articles/PMC2673971/). Accessed 24 May 2024.
- “Nanomaterials.” *National Institute of Environmental Health Sciences, U.S. Department of*

- Health and Human Services*, [www.niehs.nih.gov/health/topics/agents/sya-nano#:~:text=Nano%2D-sized%20particles%20exist%20in,less%20than%20approximately%20100%20nanometers](http://www.niehs.nih.gov/health/topics/agents/sya-nano#:~:text=Nano%2D-sized%20particles%20exist%20in,less%20than%20approximately%20100%20nanometers). Accessed 23 June 2024.
- Natesan, Vijayakumar, and Sung-Jin Kim. “The Trend of Organic Based Nanoparticles in the Treatment of Diabetes and Its Perspectives.” *Biomolecules & Therapeutics*, U.S. National Library of Medicine, 2023, [www.ncbi.nlm.nih.gov/pmc/articles/PMC9810454/#:~:text=The%20organic%2Dbased%20nanoparticles%20can,drug\)%20and%20thus%20their%20bioavailability](http://www.ncbi.nlm.nih.gov/pmc/articles/PMC9810454/#:~:text=The%20organic%2Dbased%20nanoparticles%20can,drug)%20and%20thus%20their%20bioavailability). Accessed 24 May 2024.
- Navazi, Zahra Ranjbar, et al. “Carbon Nanotubes: Superfabric Nanoscale Theranostic Materials.” *Inorganic Nanosystems*, Academic Press, 24 Mar. 2023, [www.sciencedirect.com/science/article/abs/pii/B9780323857840000042](http://www.sciencedirect.com/science/article/abs/pii/B9780323857840000042). Accessed 08 June 2024.
- Ou, Lingling, et al. “Toxicity of graphene-family nanoparticles: a general review of the origins and mechanisms.” *Particle and Fibre Toxicology*, vol. 13, no. 1, 31 Oct. 2016, doi:10.1186/s12989-016-0168-y. Accessed 03 June 2024.
- Patel, Sunny C, et al. “Graphene-Based Platforms for Cancer Therapeutics.” *Therapeutic Delivery*, U.S. National Library of Medicine, [www.ncbi.nlm.nih.gov/pmc/articles/PMC4976992/#:~:text=Graphene%20is%20a%20multifunctional%20carbon,tissue%20to%20improve%20treatment%20efficacies](http://www.ncbi.nlm.nih.gov/pmc/articles/PMC4976992/#:~:text=Graphene%20is%20a%20multifunctional%20carbon,tissue%20to%20improve%20treatment%20efficacies). Accessed 04 June 2024.
- Phillips, Theresa. “Small Non-coding RNA and Gene Expression.” *Nature News*, Nature Publishing Group, [www.nature.com/scitable/topicpage/small-non-coding-rna-and-gene-expression-1078/#:~:text=The%20duplex%20siRNAs%20are%20passed,RNA%20degradation%20and%20translational%20inhibition](http://www.nature.com/scitable/topicpage/small-non-coding-rna-and-gene-expression-1078/#:~:text=The%20duplex%20siRNAs%20are%20passed,RNA%20degradation%20and%20translational%20inhibition). Accessed 04 June 2024.
- “Questions and Answers about CRISPR.” *Broad Institute*, 17 Dec. 2014, [www.broadinstitute.org/what-broad/areas-focus/project-spotlight/questions-and-answers-about-crispr](http://www.broadinstitute.org/what-broad/areas-focus/project-spotlight/questions-and-answers-about-crispr). Accessed 24 May 2024.
- Ray, Sekhar C. “Application and Uses of Graphene Oxide and Reduced Graphene Oxide.” *Applications of Graphene and Graphene-Oxide Based Nanomaterials*, William Andrew Publishing, 20 Feb. 2015, [www.sciencedirect.com/science/article/abs/pii/B9780323375214000029](http://www.sciencedirect.com/science/article/abs/pii/B9780323375214000029). Accessed 07 June 2024.
- Siqueira Jr., J.R., and Osvaldo N. Oliveira Jr. “Carbon-Based Nanomaterials.” *Nanostructures*, William Andrew Publishing, 28 Oct. 2016, [www.sciencedirect.com/science/article/abs/pii/B9780323497824000097#:~:text=Fullerenes%2C%20nanotubes%2C%20and%20graphene%20are,a%20wide%20range%20of%20technologies](http://www.sciencedirect.com/science/article/abs/pii/B9780323497824000097#:~:text=Fullerenes%2C%20nanotubes%2C%20and%20graphene%20are,a%20wide%20range%20of%20technologies). Accessed 24 May 2024.
- Taneva, Stefka G. et al. “Insights into Graphene Oxide Interaction with Human Serum Albumin in Isolated State and in Blood Plasma.” *International Journal of Biological Macromolecules*, Elsevier, 2021, [www.sciencedirect.com/science/article/abs/pii/S0141813021001938](http://www.sciencedirect.com/science/article/abs/pii/S0141813021001938). Accessed 03 June 2024.
- Tsagkalias, Ioannis S, and Dimitrios S. Achillias. “Role of Functional Groups in the Monomer

- Molecule on the Radical Polymerization in the Presence of Graphene Oxide. Polymerization of Hydroxyethyl Acrylate under Isothermal and Non-Isothermal Conditions.” *Molecules (Basel, Switzerland)*, U.S. National Library of Medicine, 6 Jan. 2022, [pubmed.ncbi.nlm.nih.gov/35056660/#:~:text=Functional%20groups%20in%20a%20monomer,possible%20formation%20of%20side%20bonds](https://pubmed.ncbi.nlm.nih.gov/35056660/#:~:text=Functional%20groups%20in%20a%20monomer,possible%20formation%20of%20side%20bonds). Accessed 11 June 2024.
- Walton, David R.M., and Harold W. Kroto. “Fullerene.” *Encyclopædia Britannica*, *Encyclopædia Britannica, Inc.*, 18 May 2024, [www.britannica.com/science/fullerene](https://www.britannica.com/science/fullerene). Accessed 07 June 2024.
- Wang, Yan, et al. “Graphene-Based Nanomaterials for Cancer Therapy and Anti-Infections.” *Bioactive Materials*, U.S. National Library of Medicine, 5 Feb. 2022, [www.ncbi.nlm.nih.gov/pmc/articles/PMC8964986/#:~:text=Graphical%20abstract-,Graphene%2Dbased%20nanomaterials%20\(GBNMs\)%20has%20been%20thoroughly%20investigated%20and,unique%20structure%20and%20excellent%20properties](https://www.ncbi.nlm.nih.gov/pmc/articles/PMC8964986/#:~:text=Graphical%20abstract-,Graphene%2Dbased%20nanomaterials%20(GBNMs)%20has%20been%20thoroughly%20investigated%20and,unique%20structure%20and%20excellent%20properties). Accessed 24 May 2024.
- Wu, Xin, et al. “Graphene and Graphene-Based Nanomaterials for DNA Detection: A Review.” *Molecules (Basel, Switzerland)*, U.S. National Library of Medicine, 16 Aug. 2018, [www.ncbi.nlm.nih.gov/pmc/articles/PMC6222676/#:~:text=The%20interaction%20between%20graphene%20and,bases%20%5B84%2C85%5D](https://www.ncbi.nlm.nih.gov/pmc/articles/PMC6222676/#:~:text=The%20interaction%20between%20graphene%20and,bases%20%5B84%2C85%5D). Accessed 03 June 2024.
- Xu, Jingjing, et al. “Carbon Nanomaterials.” *Nano-Inspired Biosensors for Protein Assay with Clinical Applications*, Elsevier, 7 Sept. 2018, [www.sciencedirect.com/science/article/abs/pii/B9780128150535000015](https://www.sciencedirect.com/science/article/abs/pii/B9780128150535000015). Accessed 11 June 2024.
- Yusaf, Talal, et al. “A Comprehensive Review on Graphene Nanoparticles: Preparation, Properties, and Applications.” *MDPI, Multidisciplinary Digital Publishing Institute*, 28 Sept. 2022, [www.mdpi.com/2071-1050/14/19/12336](https://www.mdpi.com/2071-1050/14/19/12336). Accessed 24 May 2024.
- Zhu, Y. J., and Chen, F. (2015). “pH-responsive drug-delivery systems.” *Chemistry—An Asian J.* 10, 284–305. doi:10.1002/asia.201402715. Accessed 17 June 2024.

## The Role of Platinum in the Green Energy Revolution by Nicholas C. Burgess

### Abstract

Platinum is an important element needed for producing “green” hydrogen, hydrogen produced from renewable energy sources. This paper is a comprehensive overview of platinum, describing various factors from the geology of platinum to its use in energy technology. Platinum is a highly efficient catalyst used in electrolyzers to generate hydrogen from water and to build hydrogen fuel cells. Published theories describing the unique physics and chemistry of platinum in relation to interactions with hydrogen will be explored. The key advantages and disadvantages of platinum compared to alternative materials in the green hydrogen and fuel cell industry will be discussed. Geological occurrences, the global economics of the platinum supply chain, and geopolitical challenges which could result in future supply disruptions will be described.

### Introduction

Hydrogen has been used for many decades to power fuel cells to drive electrical motors. A major advantage of hydrogen power over internal combustion engines burning fossil fuels is that hydrogen fuel cells only emit water vapor, and no harmful CO<sub>2</sub> emissions (IEA). Therefore, hydrogen fuel cells will likely play a growing role in decarbonizing energy systems with the objective of minimizing humanity’s impact on climate change. Fuel cells have significant advantages over battery electric vehicles (BEVs) in heavy commercial vehicles such as tractors, busses, trucks, construction equipment and trains because hydrogen fuel cells are lighter and quick to re-fuel. Several methods are used to produce hydrogen, but only recently has hydrogen been produced at a commercial scale using renewable energy instead of fossil fuels. “Green hydrogen” is the common name for producing hydrogen from renewable energy, where solar, wind or hydropower is used as a source of electricity in electrolysis of water to produce hydrogen (Crownhart).

Historically, most commercial hydrogen production has been generated whereby the hydrocarbon, methane gas, is combined with high temperature steam to generate both hydrogen and CO<sub>2</sub> gas by a process known as steam-methane reforming (SMR). In 2019, ~75% of global hydrogen was being produced with this method (IEA). If the CO<sub>2</sub> is released into the atmosphere in the process, the resulting hydrogen is commonly called “gray hydrogen” (Crownhart). However, if the same SMR process is used, but the CO<sub>2</sub> is injected underground using carbon capture and storage (CCS) to minimize harmful CO<sub>2</sub> emissions which cause climate change; the resulting hydrogen is commonly called “blue hydrogen”<sup>(Crownhart)</sup>. Adding CCS to SMR plants to generate blue hydrogen leads to higher cost hydrogen but results in approximately 9% to 25% lower greenhouse gas emissions compared to gray hydrogen, depending on the efficiency of the processes (Howarth). In the most promising regions of the world, costs for blue hydrogen in 2019 were in the range of USD \$1.4–\$1.5/kg of hydrogen, making it one of the lowest cost hydrogen production methods that purposefully aims to reduce greenhouse gas emissions (Figure-1).

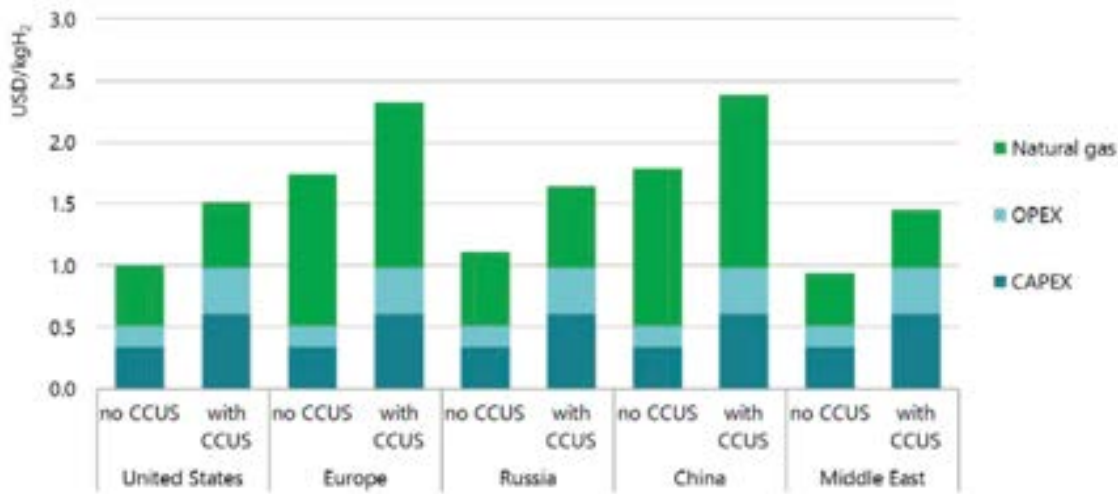

Figure 1: Hydrogen production costs using natural gas in different regions, 2018. (IEA)

A 2021 peer-reviewed paper by Howarth and Jacobson examined the lifecycle greenhouse gas emissions of blue hydrogen, accounting for emissions of both carbon dioxide and unburned fugitive methane (Howarth). They concluded that blue hydrogen is far from being low carbon, and its related greenhouse gas emissions are quite high, particularly when the release of fugitive methane is also accounted for (methane gas that escapes to the atmosphere from the total gas production and SMR process). This study quantified the surprisingly large contribution of leaking methane in the blue hydrogen supply chain. Because molecules of methane have a Global Warming Potential (GWP) approximately 86 times higher than CO<sub>2</sub>, the greenhouse gas footprint of blue hydrogen is more than 20% greater than burning natural gas. In this analysis, even coal and diesel oil burned for heat create lower greenhouse gas emissions than blue hydrogen (Howarth).

Coal can also be used as a hydrocarbon source for hydrogen production. In 2019 coal as a source accounted for ~23% of global hydrogen production due to the dominance of coal-gasification used to generate hydrogen in China (IEA). Hydrogen production from coal using gasification is an established technology which has been used in the chemical and fertilizer industries for making ammonia. When coal is used as a source to produce hydrogen the process is commonly called “brown hydrogen or black hydrogen” (Crownhart). In 2019, ~130 coal gasification plants were in operation around the globe, > 80% located in China. Hydrogen production using coal produces CO<sub>2</sub> emissions of about 19 metric tons of CO<sub>2</sub> per metric ton of hydrogen, which is twice the CO<sub>2</sub> emissions compared to gray hydrogen from SMR natural gas (IEA).



One problem with green hydrogen is its cost of production compared to gray or blue hydrogen. In 2023, the average cost of producing green hydrogen in the US was ~\$5/kg which is approximately double the cost of producing gray-hydrogen hydrogen with natural gas (USDE). However, government incentives and funding of research and development in the green hydrogen production sector in many nations aims to bring down the cost of green hydrogen production. A US Department of Energy initiative called the “Hydrogen Shot” is funding research and development of new technologies with the goal of reducing the cost of green hydrogen to less than \$1/kg by 2032 to increase the use of green hydrogen in the USA (USDE).

### Role in Addressing Climate Change

The increase in the Earth’s global average surface temperatures has been measured as roughly 1° C since the pre-industrial era, defined as 1850-1900 in NOAA’s record. This may seem to be a small magnitude of warming, but a massive amount of heat energy needs to be added to the Earth’s atmosphere to raise the average temperature even by 1° C because of the tremendous size and heat capacity of the global oceans (R. Lindsey). This global warming has been largely driven by human emissions of greenhouse gasses, with CO<sub>2</sub> being the major contributor to this climate change. According to observations by the NOAA Global Monitoring Lab, CO<sub>2</sub> was responsible for approximately two-thirds of the total heating influence of all human-produced greenhouse gasses as of 2021 (Figure-2).

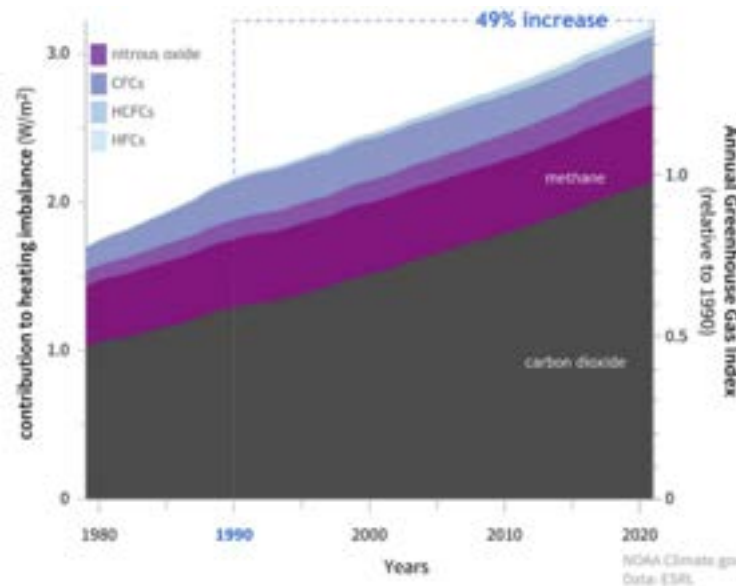

Figure 3: Heating influence caused by human-produced greenhouse gasses: CO<sub>2</sub> (gray), methane (dark purple), NO<sub>2</sub> (medium purple), CFCs (lavender), HCFCs (blue), and HFCs (light blue). CO<sub>2</sub> is the largest contributor to the Earth’s heating imbalance. (NOAA)

Measurements of CO<sub>2</sub> in the Earth's atmosphere have been accurately and continuously measured starting in 1958 at the Mauna Loa Observatory in Hawaii; the average annual CO<sub>2</sub> concentration has risen from 318 ppm in 1958 to 421 ppm in 2023 (NOAA2). In the 1960s, the Earth's growth rate of atmospheric CO<sub>2</sub> was roughly 0.8± 0.1 ppm / year. Over the next fifty years, the annual CO<sub>2</sub> concentration growth rate tripled, reaching 2.4 ppm / year by the 2010s (NOAA2). The annual rate of increase in atmospheric CO<sub>2</sub> over the past 60 years is 100 times faster than previous natural increases, including those that led to the end of the last ice age 11,000 years ago (NOAA2).

Carbon dioxide is produced by many complex processes, but burning fossil fuels (coal, natural gas, and oil) which are composed of hydrocarbon molecules containing carbon that plants pulled out of the atmosphere through photosynthesis over millions of years is the largest contributor to the ongoing CO<sub>2</sub> buildup in the atmosphere (NOAA). Burning hydrocarbons and activities such as deforestation and farming have contributed to increasing CO<sub>2</sub> emissions into the Earth's atmosphere. The similarity of increases in global atmospheric carbon dioxide concentration compared to annual CO<sub>2</sub> emissions since 1750 provides a convincing argument that human induced emissions are the primary cause of the accelerating CO<sub>2</sub> buildup in the atmosphere. The net increase in CO<sub>2</sub> and the resulting global warming due to the greenhouse effect has created a major incentive for sustainable technologies that are needed to decrease the emissions of CO<sub>2</sub> into the atmosphere (NOAA). It will be necessary to reduce CO<sub>2</sub> emissions with an estimated 80% reduction by 2050, to stabilize the carbon dioxide concentration of the Earth's atmosphere at a concentration of 450 ppm by 2050 which is consistent with the objective of limiting the global average temperature increase to +2°C in the year 2100 (Reverdiau). The development of new types of vehicles powered by electric technologies is one way to meet this climate goal. There are currently three such technologies: Battery Electric Vehicles (BEVs), Fuel Cell Electric Vehicles (FCEVs) and Plug-in Hybrid Electric Vehicles (PHEVs).

While the use of hydrogen fuel cells does not generally contribute to greenhouse gas emissions, to date the production of most hydrogen is based on steam methane reforming of natural gas, resulting in significant CO<sub>2</sub> emissions (IEA). Hydrogen can be extracted from fossil fuels, biomass, or water. Approximately 2% of global total primary energy demand is used to produce hydrogen today (IEA). Natural gas is currently the main source of hydrogen production, and steam methane reformers are the major method to produce hydrogen for the ammonia, methanol, and oil refinery industries. Natural gas accounts for approximately 75% of global hydrogen production, which is approximately around 70 million metric tons of hydrogen. 6% of global natural gas demand is consumed for this hydrogen production (IEA). Gray hydrogen based on SMR is the cheapest way to produce hydrogen today, but the associated greenhouse gas emissions are high, at 13.7 kg CO<sub>2</sub> for every 1 kg of hydrogen produced (Howarth). Coal is the second-largest source for hydrogen production today; coal is the source for ~23% of global hydrogen production and consumes ~2% of global coal demand (Howarth). Oil and electricity account for the remainder of hydrogen production. Most hydrogen production today generates significant CO<sub>2</sub> emissions because it depends largely on fossil fuel sources. This results in total

CO<sub>2</sub> emissions of 830 million metric tons per year, equivalent to the combined CO<sub>2</sub> emissions of Indonesia and the United Kingdom (IEA).

Green hydrogen produced from renewable energy technologies such as wind, solar, and hydropower present an opportunity for hydrogen to be used without any CO<sub>2</sub> emissions. However, one key challenge for green hydrogen is to lower the cost of production to match lower cost methods of producing hydrogen from hydrocarbons. Green hydrogen production costs vary greatly depending on the location as illustrated in the 2019 IEA report. Some regions have advantageous conditions for these renewable energy sources. In 2019 the cost of hydrogen production made from electricity with combined solar and wind power varied from USD \$1.6/kg H<sub>2</sub> to over \$40 /kg H<sub>2</sub> (IEA).

Hydrogen is a suitable solution to replace a significant percentage of fossil fuels in heavy industries and commercial transportation, but the global production and distribution system is currently limited, and hydrogen is mostly not produced with renewable energy. The World Bank forecasts that green hydrogen will not surpass hydrogen generated from hydrocarbons until 2041 (Moreira and Laing). Platinum is the standard element required as a catalyst for both green hydrogen production using electrolyzers and for consuming hydrogen in fuel cells, but platinum is expensive and future platinum ore mined from a limited number of geological deposits, creates possible geopolitical supply risks. Alternative catalyst materials to platinum have not yet been commercially successful.

## **History of Hydrogen Use**

### **Early Hydrogen Production and the Origins of Green Hydrogen**

Hydrogen has been part of the energy industry for a long time. The first laboratory water electrolysis and fuel cells captured the imagination of engineers and science fiction writers like Jules Verne in the 1800s (DOE). Hydrogen was used as a fuel in the first internal combustion engines 200 years ago. Hydrogen gas lifted balloons in the 1700s and 1800s, and hydrogen was a major component of rocket fuel in NASA's missions to the moon in the 1960s and 1970s. Hydrogen is a key molecule in ammonia fertilizer made from natural gas and, earlier, from electricity and water hydrolysis. This chemical fertilizer has maintained enough crops to feed a rapidly growing world for the last 100 years. Hydrogen has also been a key part of the energy industry since the 1960s, when its use became a standard in oil refining to produce fuels, plastics, and other petrochemicals (DOE). The demand for hydrogen for various purposes has steadily been growing since the 1970's, but today most hydrogen is used in the petroleum refining process to produce fuels such as gasoline and diesel (IEA).

In the 1920s, British scientist and Marxist author J.B.S. Haldane introduced the concept of renewable hydrogen in his paper, *Science and the Future*, by writing, "There will be great power stations where during windy weather, the surplus power will be used for the electrolytic decomposition of water into oxygen and hydrogen." (DOE). In 1990, the first solar powered hydrogen production plant was built for research and testing in Germany at Solar-Wasserstoff-Bayern. In the same year, the U.S. Congress passed the Spark M. Matsunaga

Hydrogen, Research, Development and Demonstration Act to fund hydrogen research and development in the US (DOE). Many new green hydrogen plants are planned across the globe, from Europe, Australia, Africa, Kazakhstan, and the Middle East (FuelCellWorks). Several recently announced projects claim to be the world’s largest green hydrogen project; one of these is the NEOM plant under construction in western Saudi Arabia. When completed, the project will mitigate the impact of 5 million metric tons of carbon emissions per year (NEOM).

### History of Fuel Cells

In 1839, Swiss chemist Christian Friedrich Schoenbein discovered the fuel cell effect by combining hydrogen and oxygen gasses to produce water and an electric current. In 1849, English scientist Sir William Grove “The Father of the Fuel Cell” demonstrated a fuel cell at a practical scale when he built and demonstrated an invention dubbed “the gas battery” (DOE). In 1959, Francis T. Bacon of Cambridge University built the first practical hydrogen-air fuel cell. The 5-kilowatt system was used to power a welding machine. Later in 1959, Harry Karl Ihrig built the first fuel cell vehicle which powered a small tractor. Hydrogen fuel cells, based on the 1959 Bacon design, have been used by NASA space flights to make on-board electricity, heat, and water for astronauts. In 1994, Daimler Benz demonstrated the NECA-I, its first hydrogen fuel cell passenger vehicle (DOE).

### Electrolysis in Hydrogen Production

One way of producing hydrogen is through an electrochemical process called electrolysis of water. During the electrolysis process, an electric current is used to separate water molecules into its basic elements, hydrogen and oxygen (IEA). One important advantage of the electrolysis method is that there are no CO<sub>2</sub> emissions. The electrolysis reaction with the thermodynamic energy values is described in Equation-1. When the electric current is derived from a renewable source such as solar power, wind turbine, or hydroelectric power, it is known as green hydrogen (Crownhart).

Three main electrolysis technologies are used to produce hydrogen from water: alkaline electrolysis, proton exchange membrane (PEM) electrolysis, and solid oxide electrolysis cells (SOECs) (IEA). The technical and economic characteristics of each method are summarized in Table-1. This paper focuses on PEM electrolysis, but a general description of the other two methods follows.

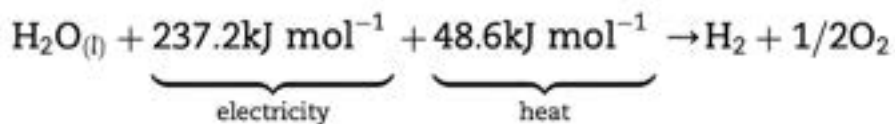

Equation 1: Hydrolysis reaction with the thermodynamic energy values. (Carmo)

Three main electrolysis technologies are used to produce hydrogen from water: alkaline electrolysis, proton exchange membrane (PEM) electrolysis, and solid oxide electrolysis cells

(SOECs) (IEA). The technical and economic characteristics of each method are summarized in Table-1. This paper focuses on PEM electrolysis, but a general description of the other two methods follows.

<b>Table-1 Techno-economic characteristics of different eletrolyzer technologies (2019)</b>			
	<b>Alkaline electrolyzer</b>	<b>PEM electrolyzer</b>	<b>SOEC electrolyzer</b>
Electrical efficiency (% LHV)	63 - 70	56 - 60	74 - 81
Operating Pressure (bar)	30-Jan	30 - 80	1
Operating temperature (deg C)	60 - 80	50 - 80	650 - 1,000
Stack lifetime (operating hours)	60,000 - 90,000	30,000 - 90,000	10,000 - 30,000
Load range (% relative to nominal load)	10 - 110	0 - 160	20 - 100
Plant footprint (sqm/kWe)	0.095	0.048	NA
Electrical efficiency (% LHV)	63 - 70	56 - 60	74 - 81
CAPEX (USD/kWe)	500 - 1,400	1,100 - 1,800	2,800 - 5,800

Table 1: Techno-economic characteristics of different electrolyzer technologies. CAPEX refers to capital expenditures, the funds used to acquire and maintain the asset. (IEA)

Alkaline electrolysis is a technology which has been used commercially for over 100 years in the fertilizer and chlorine industries for hydrogen production. Many large alkaline electrolyzers with a capacity of up to 165 megawatts were built in the last century in countries with large hydropower electrical supplies such as Canada, Egypt, India, Norway and Zimbabwe (IEA). Most of these older, large alkaline electrolysis facilities were decommissioned when the alternative methods of natural gas and steam methane reforming for hydrogen production became common in the 1970s. Alkaline electrolysis has a relatively low installation cost compared to other technologies because precious materials such as platinum are not required.

However, there are three major drawbacks often associated with alkaline electrolyzers: low partial load range, limited current density, and low operating pressures. The first issue can create a serious safety issue at low loads, where the oxygen production rate decreases, thus drastically increasing the hydrogen concentration to dangerous levels which could result in an explosion. An example of a problematic alkaline electrolysis facility is Sinopec's 260MW Kuqa facility, one of the world's largest green hydrogen projects that was commissioned in northwest China in 2023. Its electrical power comes from a large solar energy facility. Unfortunately, its alkaline electrolyzers have been operating at less than one third of its installed capacity due to various factors, including missing safety features and lower efficiencies than originally designed. When the input electric power supply drops below 50%, the electrolyzers stop producing hydrogen completely, causing reliability and safety issues related to renewable-energy fluctuations (Insight).

SOECs are the least developed electrolysis technology, and as of 2019 SOECs have still not been used at a commercial scale (IEA). SOECs use ceramics as the electrolyte which lowers the material costs, and they do not require platinum group elements. SOECs work at high

temperatures and are highly efficient. Because they use steam for electrolysis, they need a heat source. SOECs can be operated in reverse mode as a fuel cell (IEA). In this mode, these devices convert hydrogen back into electricity, which means SOECs could provide balancing services to the electric grid if combined with hydrogen storage. The main drawback of SOECs has been durability because the internal materials degrade under high operating temperatures (IEA).

### **Proton Exchange Membrane (PEM) Electrolysis**

PEM electrolyzers were originally invented in the 1960s by General Electric Company to solve some of the problems of alkaline electrolyzers. The PEM method uses purified water as an electrolyte solution, so PEM does not need to recover or recycle the potassium hydroxide electrolyte solution that is necessary with alkaline electrolyzer technology (IEA). PEM systems are smaller, making them more suitable for most applications. PEM can produce highly compressed hydrogen gas for production and storage at refueling stations (IEA). PEM also offers flexible operation, and their operating range can quickly go from zero to full production. However, PEM electrolyzers require expensive platinum and iridium electrode catalysts and costly membrane materials, and their lifetime is currently shorter than that of alkaline electrolyzers. Their overall costs are currently higher than those of alkaline electrolyzers, so PEM has been less widely deployed, but PEM technology is rapidly growing today due to its compatibility with renewable energy sources (IEA).

Carmo, et. al. published a 2013 comprehensive review on PEM water electrolysis, including how this type of electrolyzer works, a history of research and development, and a detailed summary of various published literature on PEM electrolyzer research. It focused on various attempts to improve the effectiveness, durability, and lower the cost of PEM systems (Carmo). In a PEM electrolyzer, platinum and iridium are used as catalysts at the cathode and anode respectively. These catalysts are applied directly with several different methods to a thin membrane acting as a solid polymer electrolyte. Figure-4 is a schematic illustration of the components and functions of a typical PEM Electrolyzer. PEM electrolysis technology offers advantages over the other two electrolyzer technologies because PEM devices are compact and more able to operate under the intermittent nature of electricity from wind or solar sources, so PEM offers the performance and durability necessary for commercial scale green hydrogen systems (Carmo).

The solid polymer electrolyte concept in PEM electrolyzers was idealized by Grubb, where a solid sulfonated polystyrene membrane was used as an electrolyte (Grubb). This concept is referred to as proton exchange membrane or polymer electrolyte membrane (PEM) water electrolysis, and less frequently as solid polymer electrolyte (SPE) water electrolysis (Carmo). In PEM electrolysis, a thin (~100  $\mu$ m) perfluoro sulfonate polymer membrane (PFSA) is used as a solid electrolyte. This is a class of synthetic polymers with ionic properties that are called ionomers (Carmo). The commercially branded Nafion membrane, invented in the late 1960s by Dr. Walther Grot of DuPont Company, is one of the main types of materials used due to its excellent chemical and thermal stability, mechanical strength, and high proton conductivity

(Carmo). However, this material has two key disadvantages, cost and disposal. Nafion disposal is environmentally challenging because it contains fluorine (Carmo).

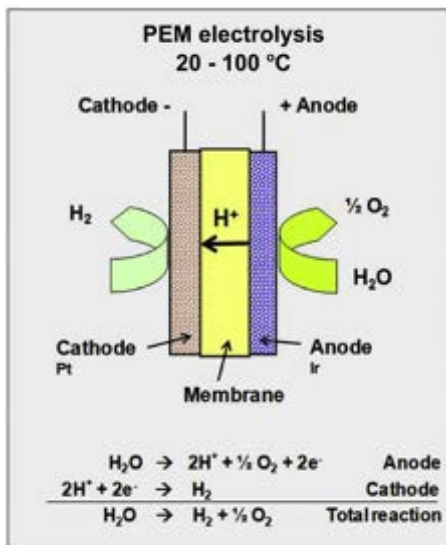

Figure 1: Schematic of the operating principle of a PEM water electrolysis cell (Carmo).

Carmo, et. al. 2013 describes concisely how a PEM water electrolyzer functions. In PEM water electrolyzers, water is supplied into the anode side of the cell, where oxygen evolution reaction (OER) takes place. The water travels via small channels in the separator plates and diffuses through the current collector. The water then reaches the catalyst layer, where the molecules are split into electrons, oxygen, and protons. The oxygen gas flows back through the catalyst layer and current collector to the separator plates in the opposite direction from the flow of water, and then the oxygen leaves the cell. The electrons travel from the catalytic layer, through the current collector, then through the separator plates, and then the electrons go to the cathode side. The protons leave the anode catalytic layer through the ionomer, reaching the membrane and passing through to the cathode side. After reaching the catalytic layer these protons will combine with electrons to form hydrogen gas molecules. The hydrogen gas then flows across the cathode current collector and the cathode separator plate, and finally hydrogen leaves the cell (Carmo). After 50 years of research, PEM electrolysis technology is still dependent on costly Nafion membranes, iridium for the anode, platinum for the cathode, and titanium for the current collectors and separator plates (Carmo). However, this situation can be attributed to the fact that not much research was done on PEM water electrolysis until the late 1990s (Carmo). The widespread concern about climate change, however, has generated new interest for PEM electrolysis to produce green hydrogen; evidence for this interest is seen in the rapid growth in recent publications on PEM electrolysis.

Since 1990, there has been a rapid increase in new PEM electrolysis installations. Now, PEM accounts for the largest growth in new electrolyzer technology. Figure-5 illustrates the

development of new electrolyzer capacity additions for energy projects globally. Prior to 2015, most new built electrolyzers were based on alkaline technology. However, between 2015 and 2019, as the number of electrolyzer projects rapidly grew, PEM systems became the dominant type of newly built electrolyzer technology globally. PEM technology has been chosen for 90% of the 100 new electrolyzer projects built during the most recent five-year period. Most new green hydrogen electrolyzer projects are being built in Europe, but similar facilities have also been announced in Australia, China and the Americas (IEA). Over the last 20 years, the average capacity of new electrolyzers has increased from 0.1 MWe to 1.0 MWe indicating a shift from small, demonstration facilities to commercial-scale plants. The growing economies of scale will contribute to lower unit capital costs in USD/kW and increase the supply of hydrogen sourced from PEM electrolyzers (IEA).

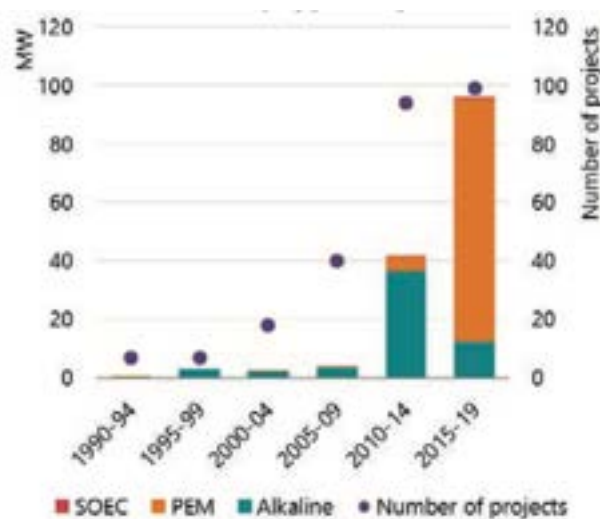

Figure 5: Development of electrolyzer capacity additions for energy purposes and their average unit size, 1990–2019. (IEA)

## Fuel Cells

Proton exchange membrane fuel cells (PEMFCs) dominate the transportation fuel cell market, and platinum is the catalyst material used for both anode and cathode inside these fuel cells (Price). A fuel cell’s technology is essentially the inverse of an electrolyzer, generating electricity through an electrochemical reaction of hydrogen and oxygen (Figure-6). The anode splits the dihydrogen into electrons and two protons. The protons then pass through a porous, electrolyte membrane driven by the oxidative potential of free oxygen from the injected air, while the electrons are forced through a circuit generating an electrical current which can be used to power an electrical motor (Price).

Hydrogen gas is fed to the anode where it adsorbs onto the catalyst surface. The adsorbed hydrogen atoms each lose an electron and are released from the metal surface as protons. The electrons flow to the cathode as current through an external circuit and the protons flow across the PEM towards the cathode. Air is fed to the cathode and oxygen is adsorbed onto the catalyst



surface. This bound oxygen is subsequently protonated by incoming  $H^+$  and reduced by incoming electrons to produce water, which is then released from the catalyst surface. This water is forced to exit the fuel cell by the hydrophobic nature of the surrounding media (Holton), so water vapor is emitted as exhaust.

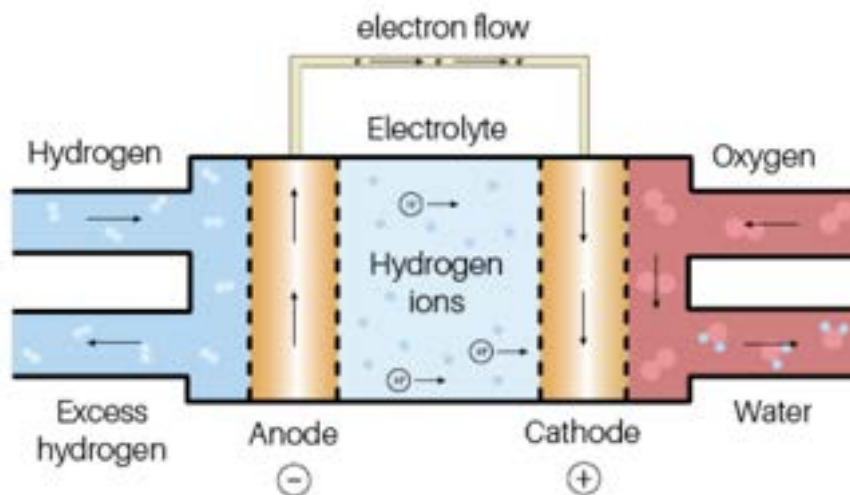

Figure 13: Schematic of proton exchange membrane (PEM) fuel cell. (Price)

A 2013 paper by Holton and Stevenson describes how PEMFCs work to generate electric power from hydrogen and various issues which make platinum and its alloys the best available materials to use for hydrogen fuel cells (Holton). This paper documents why platinum is the only element which can meet the performance requirements while avoiding slow reaction kinetics, proton exchange membrane (PEM) system degradation due to hydrogen peroxide ( $H_2O_2$ ) formation, and catalyst degradation due to metal leaching. A PEMFC electrochemically reacts hydrogen with oxygen to produce electricity with water as its only emission. These fuel cells can be used for transportation with no carbon dioxide emissions, so they have become more interesting as climate change concerns have grown in recent years (Holton). Even when hydrogen is produced from fossil fuels such as blue-hydrogen, the high efficiency of fuel cells relative to internal combustion engines still offers the potential for reduced  $CO_2$  emissions (CONCAWE). PEMFCs have been the main type of fuel cells used in the transportation market for numerous reasons. They have a unique set of advantages for cars, trucks, and heavy vehicles, including a low working temperature ( $80^\circ C$ ) so they can be started quickly; a high energy density; robust and simple mechanics; ability to run on pure hydrogen, resulting in zero  $CO_2$  emissions; and use of ambient air for the oxygen supply (Holton).

PEMFCs currently use platinum as the catalyst at both the cathode and the anode, so these fuel cells have the potential to create considerable demand for platinum (The Fuel Cell Industry Review 2012). A recent US Department of Energy analysis indicates that platinum represents approximately 17% of the total cost of an 80 kW PEMFC system using 2012 technology at commercial scale production (Holton). Because platinum is a costly material, research is being conducted to develop substitute catalysts based on less expensive metals.

Platinum is used as the catalyst for both the hydrogen oxidation reaction (HOR) occurring at the anode and the oxygen reduction reaction (ORR) at the cathode (Holton). In most PEMFCs, the platinum catalyst is deposited as small particles on the surface of somewhat larger carbon particles that act as a support matrix (Holton). At the anode, hydrogen flows into the fuel cell and reaches the platinum anode where the HOR takes place. Here the hydrogen adsorbs onto the surface of the platinum electrode, breaking the hydrogen–hydrogen bond to give adsorbed atomic hydrogen. Subsequent loss of an electron from each adsorbed hydrogen molecule leads to hydrogen leaving the surface as protons ( $H^+$ ).

The 2013 review by Holton and Stevenson also describes how the kinetics of the HOR on a platinum anode are very fast, so voltage losses are very small. As the HOR is fast, the focus of catalyst improvement has always been on the cathode process (Holton). The ORR that occurs at the cathode is more complicated and characterized by slow reaction kinetics (Holton). The ORR is the most difficult challenge for PEMFCs because the catalyst material must be stable under very corrosive conditions at a fuel cell cathode. It also must be chemically active enough to be able to activate oxygen, and the cathode material must allow the release of the produced water from the catalyst's surface to release catalytic sites once the reaction is complete. Due to the difficulties of the ORR, the cathode requires a higher concentration of platinum, more than several times that of the anode (Holton). More than half of the voltage loss for a PEMFC system occurs at the cathode (Holton).

### **Platinum as a Catalyst**

The 2012 review of PEMFCs by Holton and Stevenson (Holton) focuses on the fundamental requirements for an idealized PEMFC electrode material and evaluates the performance of pure platinum compared to other pure metals and discusses other alternatives to improve fuel cell catalysts. Figure-7 illustrates that platinum has the highest activity of all bulk metals for metal hydrogen bonding energy; this is one of the major reasons that PEM fuel cells and electrolyzers use platinum as a catalyst.

The electrode coating at the anode in PEM electrolyzers needs to be highly resistant to corrosion while supporting sufficient electrochemical activity, and iridium is one of the very few metals that meets these criteria (Price). The porous transport layer of a PEM electrolyzer requires significant amounts of titanium-based materials coated with platinum (Price). The 2013 review by Holton and Stevenson concluded that the great value of platinum as a catalyst in PEMFC systems is that it outperforms all other catalysts in each of three key areas: activity, selectivity and stability. Of all transition metals, platinum is the most ideal catalyst for both the HOR and ORR in PEM fuel cells (Holton).

Platinum performance as a catalyst in fuel cells can also be improved by an order of magnitude if its electronic properties are fine-tuned by combining platinum with other metals as alloys. It is the performance of these modified platinum-alloy PEM fuel cells that represents the benchmark with which other new materials must compete (Holton). Research into alternative metals to replace platinum for PEMFC systems using cheaper metals has not yet discovered a

better material (Holton). Alternative systems containing other metals have fundamental limitations such as a lack of activity, poor selectivity leading to hydrogen peroxide formation, or catalyst degradation caused by a lack of stability under harsh fuel cell operating conditions (Holton).

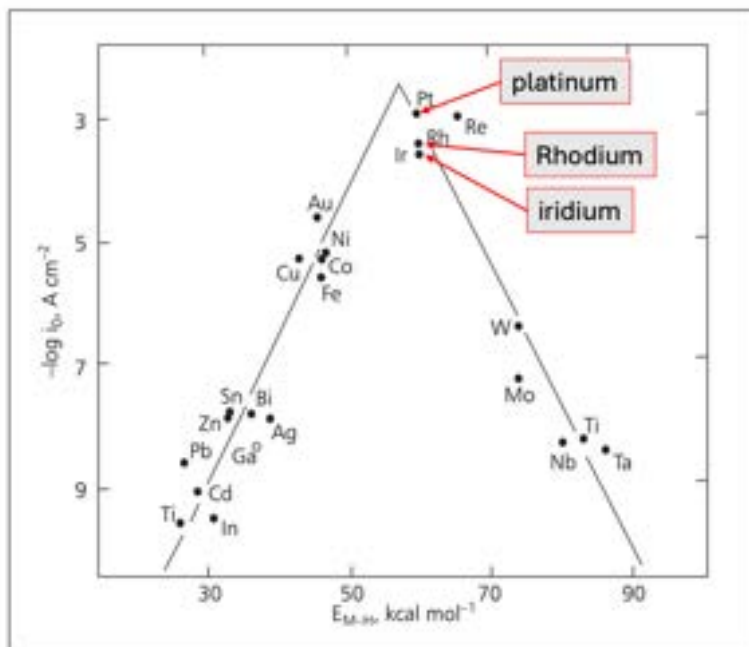

Figure 14: Exchange current densities for cathodic hydrogen evolution vs. the bonding adsorption strength of intermediate metal-hydrogen bond formed during the reaction itself; three PEM metals are highlighted at the top of the chart, with platinum at the top. (Holton)

Jaouen, et.al., 2018 reviewed the status, concepts and challenges to discover catalysts free of platinum group metals for building better and cheaper PEMFCs (Jaouen). A major challenge for the development of PEMFC technology is to replace platinum with platinum-free catalysts that perform in fuel cells with comparable activity and stability. The priority objective is the substitution of cathode catalysts used in the oxygen reduction phase, which account for more than 80% of platinum in current PEMFCs (Jaouen). Jaouen, et.al., 2018 conclude that major breakthroughs have been achieved over the last decade in the design of catalysts based on Earth-abundant metals for catalyzing the ORR or HOR that are compatible with PEMFC technology and operate with overpotential requirements similar to those of conventional platinum catalysts (Jaouen). The paper describes some advantages of these platinum-free alternatives, which can be less sensitive to poisoning, when the catalyst material degrades over time due to the harsh physical and chemical operating conditions. However, the authors also describe two key ongoing challenges that need to be overcome for any platinum substitute: 1. The electrochemical activities of substitutes are still lower than those of optimized platinum

catalysts, and 2. The stability and durability of the catalyst materials during real world fuel cell operating conditions are still not high enough for commercial purposes.

### **Global Economics of the Platinum Supply Chain**

Most PEM electrolyzer and fuel cell devices require platinum and iridium. Both metals are critical raw materials needed for hydrogen-based energy systems. Supply and demand of platinum group metals (PGM) are described in a 2023 report: Scoping Report on the Material Requirements for a UK Hydrogen Economy (Price). Platinum and iridium are two of the six platinum group metal (PGM) elements, which also include palladium, ruthenium, rhodium, and osmium. These six noble metallic elements occur together on the periodic table of elements because they have similar chemical and physical properties, and they usually occur together in the same mineral ore deposits. Platinum or palladium are often the main metals being mined commercially, and the other PGM metals are considered by-products that contribute small amounts to the producer's revenues. Often, PGM metal ores are produced as byproducts of gold, nickel, or copper mining (Mungall). Increased demand for the minor PGM metals like iridium will contribute to higher prices. However, the primary producers (mining companies) will not produce more for fear of eroding the price of the main commodity, platinum (Price).

Depending on the composition of the ore that is mined, platinum is either considered a primary or secondary metal. In South Africa, the largest platinum producing nation, platinum is the primary metal mined. Iridium is produced as a by-product of platinum mining and processing operations in South Africa, and iridium volumes accounted for only 5% of platinum volumes mined (N. E. Idoine). Because platinum is such a critical raw material in green hydrogen production and in fuel cells, it is important to understand recent trends that impact the price of platinum and iridium, including factors that impact both the supply and demand of these precious metals. The price of platinum fluctuates higher and lower due to global supply and demand in a similar manner to other raw materials and commodities, but platinum has always been a precious metal which is difficult to find in sufficiently high concentration ores to justify mining (Price). For many decades, Platinum mining has been highly geographically concentrated in South Africa, with two other countries, Russia and Zimbabwe, making up most remaining global platinum ore supplies (Figure-8). South Africa dominates the supply of platinum, maintaining production levels of between 112,000 and 142,000 kg per year over the last five years (N. E. Idoine). This platinum is mostly produced from several different mines within the world's largest platinum ore deposit called the "Bushveld complex" discovered north of Johannesburg in 1924 (Mungall).

### **Platinum Supply, Geology, and Mining**

Platinum production is supplied from two basic sources, ore that is mined from the ground, and recycling of platinum from existing devices such as vehicle catalytic converters and other machinery (IEA). Approximately 173,700 kg of platinum was produced globally by mining operations in 2022 (N. E. Idoine). 73% of platinum came from South Africa in that year (Price).

The other major producing nations are Russia which produced 12% of global platinum; Zimbabwe produced 9%, and North America produced 4% of the world’s mined platinum (Price). The British Geological Survey (BGS) published a report on the global supply of various critical minerals for the period 2018-2022 (N. E. Idoine).

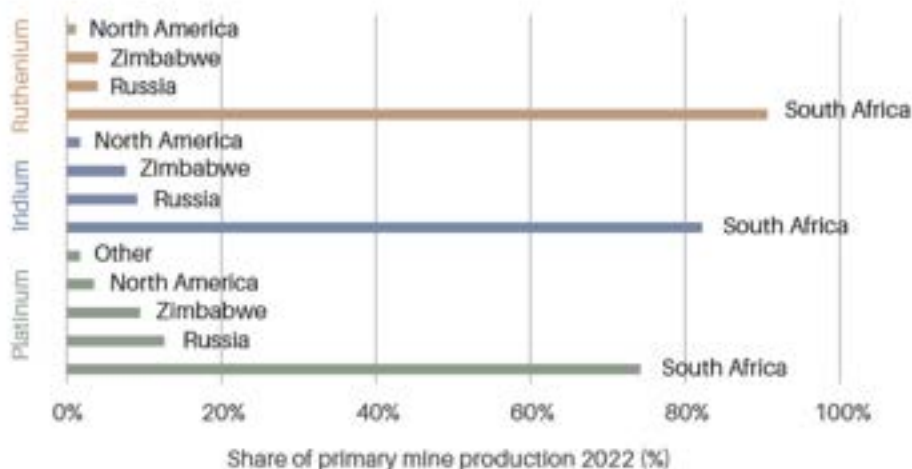

Figure 16: Share of mined platinum, iridium and ruthenium production in 2022 (Price)

The textbook, *Exploration for Platinum Group Elements*, published by the Mineralogical Association of Canada (Mungall) is a thorough and detailed work describing the geological origins of platinum, its geochemistry, types of ore deposits, and case-histories of the largest platinum ore discoveries. Most of the world’s supply of platinum and platinum group elements (PGE) is produced from magmatic ores derived from basaltic magmas (Mungall). Platinum is originally formed in a variety of intrusive igneous rocks. The tectonic origins can be mid-ocean ridges or igneous intrusions related to mantle plumes and subduction zones. Platinum is typically formed in ultramafic rocks or hydrothermal rocks, which are high in magnesium and low in silica. These platinum bearing rocks include peridotite, pyroxenite, and dunnite and are typically found in areas of ancient continental crust or in ophiolite complexes (BGS). PGE metals also share with copper, gold, and silver (Cu, Ag, Au) a tendency to prefer the formation of covalent bonds with sulfur instead of ionized bonds with oxygen; this behavior puts PGE metals in the group of “chalcophile” (copper-loving) elements.

### Production Through Recycling

Platinum is one of the most highly recycled precious metals (Figure-9). Primary production from mining represents only 35% of future supply, while 65% of platinum comes from recycling processes (Moreira and Laing). Platinum is recycled from used or discarded devices, jewelry, electronics, automobiles, medical equipment, etc. There are two types of recycling of platinum: open-loop and closed-loop processes (Price). Open-loop (secondary) recycling is the process that results in platinum available to new consumers. Closed-loop recycling takes place when industrial users of platinum such as glass making and fuel refining

continuously recycle and reuse platinum within the same facility, so this recycled volume of platinum is not available to other consumers. Open-loop recycling was responsible for 22% (48,000 kg) of global supplies of platinum in 2022 (Price).

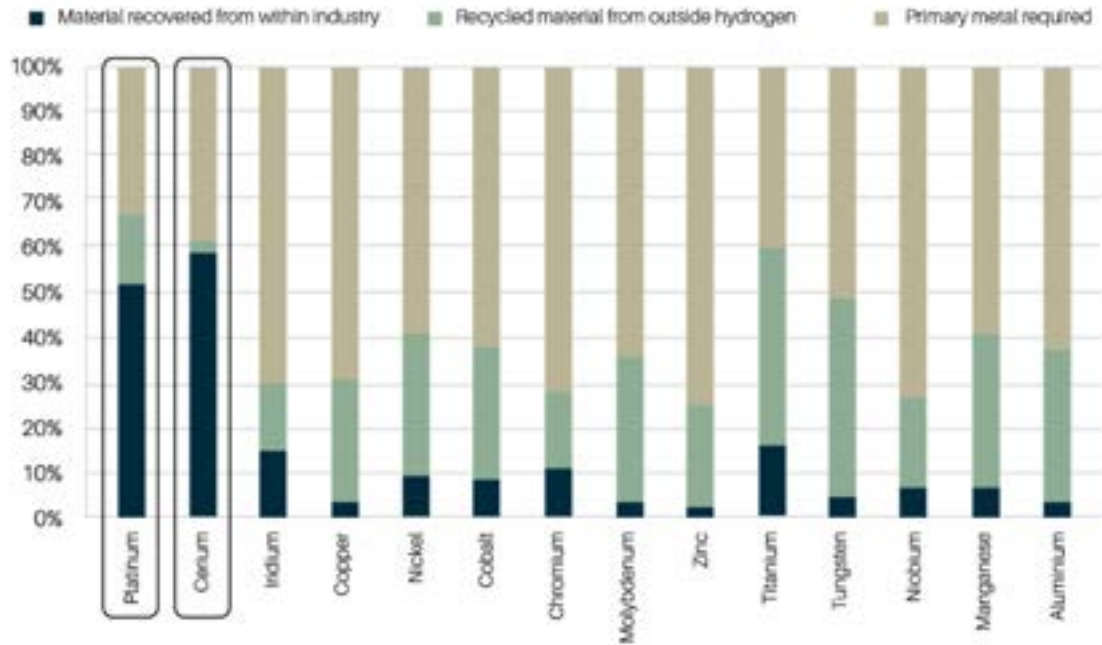

Figure 9: Sourcing rates of various metals - recovery, recycling, or mining (Moreira and Laing)

### Platinum Demand

In 2022, the global hydrogen sector accounted for 2,740 kg of platinum demand which is only 1% of total worldwide platinum demand (Price). In recent years, the top three industries creating demand for platinum are automobile emissions catalysts, jewelry, and industrial chemicals. The largest sector demand for platinum is from the automobile catalytic converter market which accounted for 43% of global platinum demand in 2022 (Price); the second largest sector demand comes from the jewelry business at 24% (Price). As of 2022, 12% of global platinum demand comes from the industrial chemical industry for production of silicone, nitric acid, and crude oil synthesis refining for fuel production (Price). Platinum’s biocompatible characteristics mean that it is also useful in a variety of medical and dental procedures as well as in the pharmaceutical industry for cancer medications (Price).

Future demand for platinum and iridium is highly uncertain and complex because some industries related to hydrogen are ramping up while other industries, related to the traditional gasoline and diesel vehicles catalytic converters, are predicted to decrease as electric vehicles and fuel cell vehicles displace internal combustion engines. A 2022 World Bank forecast for the demand of platinum and iridium linked to PEM electrolyzers illustrates the range of uncertainty of future, cumulative demand from 2022-2050 from hydrogen production technology (Figure-10). This forecast illustrates that the growth in global demand for iridium from

construction of new electrolyzers is predicted to be much higher than the growth in demand for platinum in most scenarios.

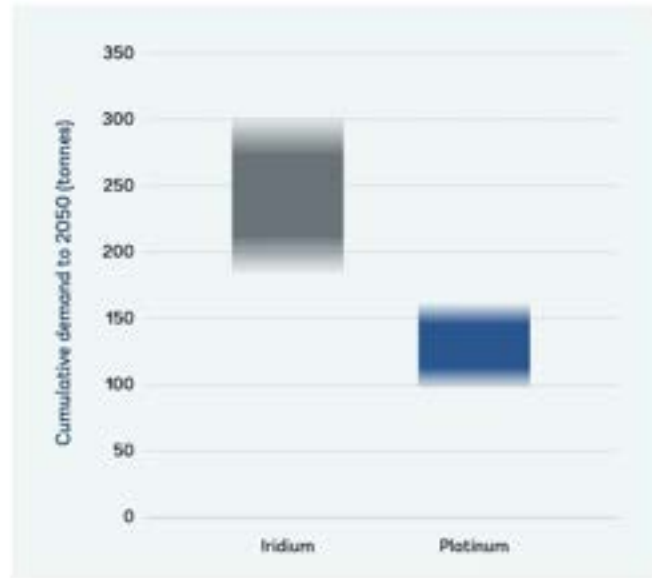

Figure 10: Projected range of cumulative gross demand up to 2050 for platinum and iridium from hydrogen production. (Moreira and Laing).

This World Bank report also forecasts that the cumulative demand for platinum related to hydrogen consumption will be dominated by PEM fuel cells and that the demand for platinum coming from hydrogen fuel cell manufacturing over the same period through 2050 is predicted to be much higher than the demand caused by electrolyzers in the hydrogen production business. These forecasts of future demand are based on many uncertain economic and technical factors, so the range on the charts reflect the World Bank’s view of uncertainty in their forecasts (Moreira and Laing).

Figure-11 illustrates the World Bank’s 2022 forecast for future platinum demand from mining sources due to the hydrogen sector until 2050 in 5-year increments. The future increase in demand for platinum from the hydrogen sector is predicted to peak in 2030’s at 60 metric tons annually and fall off after 2040 (Moreira and Laing). This represents a large increase in the percentage of globally produced platinum required for the hydrogen sector over the next decade. By 2040 the World Bank forecasts global platinum demand from the hydrogen sector to reduce to 10 metric tons annually, approximately the same demand as in the 2021-2025 period (Moreira and Laing).

Figure-12 illustrates the forecast of future primary demand (from mining sources) of platinum and iridium caused by the hydrogen sector until 2050 (Moreira and Laing). The predicted growth in demand for iridium will be larger than platinum in most scenarios, so it is likely that iridium will be even more critical than platinum in the future of green hydrogen production.

Considering the World Bank’s published forecasts for platinum demand from both hydrogen production and hydrogen consumption, the consumption side of the future hydrogen economy, especially PEM fuel cells, will dominate the future demand of platinum in the green energy industry. PEM fuel cell demand for platinum is likely to be approximately 40 times higher than demand created by PEM electrolyzers (Moreira and Laing).

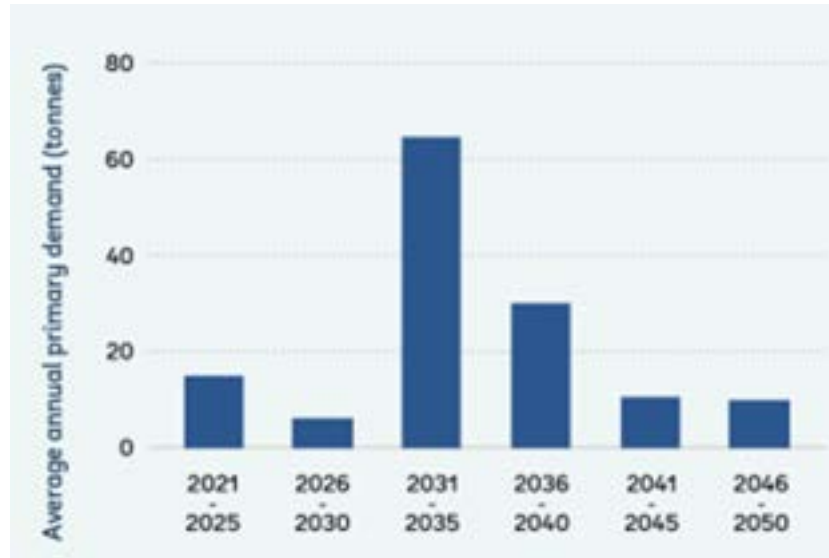

Figure 11: Projected time path for net demand for primary platinum sources (mining) from the hydrogen sector through 2050 in 5-year increments. (Moreira and Laing)

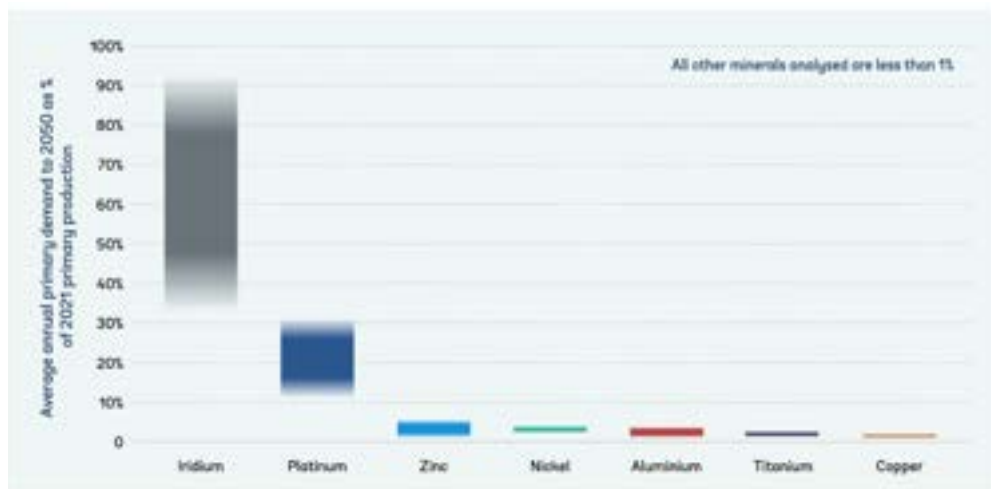

Figure 12: Projected average annual primary demand for metals (from mining sources) from the hydrogen sector to 2050 as a percentage of current primary production. (Moreira and Laing)



## Discussion

There is substantial information in the literature about the beneficial material properties of platinum as a catalyst in hydrogen energy systems compared to alternative materials. Research into alternative metals could optimize for the areas where platinum is deficient, but the current state of technology suggests that platinum is still the best catalyst option for producing hydrogen from renewable energy and for consuming hydrogen with fuel cells. Researchers have also been continually optimizing the use of platinum in hydrogen energy systems by alloying platinum with other metals to minimize the amount of platinum required for PEM electrolyzers and fuel cells.

Challenges related to platinum supply should not be ignored, including limited mining locations, processing and supply chain complexities, and competing demand for platinum and iridium from other industries. Alternative supply pathways for platinum need to be explored if platinum is to remain the metal of choice in the future with respect to use in hydrogen energy systems. The World Bank forecasts a 30% - 60% spike in global platinum demand from primary mining sources between 2030 and 2040. Unless additional primary platinum supplies become available, this could cause a strain on the supply of platinum during this period. In 2022, more than half of global platinum supply was met from recycling of discarded equipment, so recycling is an important aspect of platinum supplies; compared to other precious metals and critical materials. The dependence of recycling in the platinum supply chain could create a dilemma in the future, if recycling does not continue to produce a similar percentage of global supplies.

As many national and local governments adopt stricter regulations, limiting CO<sub>2</sub> emissions from industry and transportation, hydrogen produced from renewable energy sources will play an increasingly important role in meeting ever stricter emissions reduction targets. Blue hydrogen produced from natural gas sources has proven to be controversial because although its CO<sub>2</sub> emissions are captured and stored underground, the total greenhouse gas emissions, including methane leaks, have been demonstrated by some researchers to be as high as from simply burning fossil fuels such as natural gas, diesel, or even coal (Howarth). Therefore, an emphasis is now being placed on green hydrogen, which produces far lower greenhouse gas emissions. Despite the uncertainty in the pace of adoption of hydrogen systems in the energy transition, PEM fuel cells and electrolyzers will likely play a key role in future reductions of CO<sub>2</sub> emissions from many hard to decarbonize industries and heavy vehicle transportation.

Iridium is a byproduct of primary platinum mining and processing, so the only way to increase iridium supplies is by producing more platinum. An economic dilemma could be created if platinum is produced in larger quantities than demanded in the pursuit of larger iridium production. In this scenario, platinum prices would drop, and this could cause a disincentive for platinum mining triggered by a greater demand for iridium vs. platinum used in PEM electrolyzers. At times when this scenario becomes a reality, producers and consumers of PGM metals should prepare for potential price instability of platinum and iridium.

Geopolitical considerations are an important issue which add to the uncertainty of future platinum supplies. 85% of platinum is produced in only two nations, South Africa and Russia, so

any political or economic disturbance in either of these countries could cause platinum and iridium supply disruptions. Russia has a long history of international sanctions imposed on its businesses. Economic sanctions often result in unanticipated negative side-effects such as supply disruptions of exported commodities (UKTreasury). South Africa is even more important as a primary source of platinum because 73% of global mined platinum comes from this nation. Unfortunately, South Africa has recently experienced frequent electrical power outages. South African PGM output in 2023 was 6 per cent below producers' initial guidance and one of the worst years in the past two decades. Electrical power blackouts are expected to continue until the South African government solves the electrical power problems by investing in maintenance and modernization (Bloomberg).

Several factors contribute to creating an incentive for research into platinum alternatives: geopolitical uncertainty, growing demand from the hydrogen sector, and the fact that platinum is costly to mine and process. Alternative catalysts for fuel cells and electrolyzers will add value if they can be improved to perform as well as platinum or iridium in the future. It is crucial that recycling continues to play a major role in the future because recycling is currently a larger source of platinum production than supplies from mining. Eventually future platinum supply growth will rely on geologists to discover new sources of platinum ore in the rocks of the Earth.

### **Concluding Remarks**

This review highlights the role of platinum in the advancement of green hydrogen technologies, specifically with respect to hydrogen production from renewable energy sources and hydrogen consumption in PEM fuel cells. These hydrogen technologies are a crucial component of the energy transition which is needed to minimize the greenhouse gas emissions causing climate change. The geology of platinum has resulted in mining production from a small number of locations, concentrating platinum sources in only three nations and creating potential geopolitical risks that could impact the supply chain and economics of platinum. Surprisingly, more than half of platinum demand is met through recycling, so recycling will continue to play an important role as demand for platinum related to the hydrogen sector is expected to peak by 2040. Upon reviewing various peer-reviewed publications, it becomes evident that platinum is the superior catalyst in the production and utilization of green hydrogen. Despite these advantages, challenges such as the high cost of platinum, the geopolitics of future platinum supply, and sustainability of both primary platinum mining and recycling persist. This suggests that further research into promising alternatives such as alloys of platinum or new catalyst materials is warranted.

## Works Cited

- Bloomberg. "South Africa's Top Miner Fears Blackouts Will Threaten Platinum Supply." *The National*, 27 Jan. 2023, [www.thenationalnews.com/business/economy/2023/01/27/south-africas-top-miner-fears-blackouts-will-threaten-platinum-supply/](http://www.thenationalnews.com/business/economy/2023/01/27/south-africas-top-miner-fears-blackouts-will-threaten-platinum-supply/).
- Carmo, Marcelo, et al. "A Comprehensive Review on PEM Water Electrolysis." *International Journal of Hydrogen Energy*, vol. 38, no. 12, Apr. 2013, pp. 4901–4934, <https://doi.org/10.1016/j.ijhydene.2013.01.151>.
- Collins (l\_collins), Leigh. "EXCLUSIVE | World's Largest Green Hydrogen Project "Has Major Problems due to Its Chinese Electrolysers": BNEF." *Hydrogen News and Intelligence | Hydrogen Insight*, 11 Dec. 2023, [www.hydrogeninsight.com/production/exclusive-worlds-largest-green-hydrogen-project-has-major-problems-due-to-its-chinese-electrolysers-bnef/2-1-1566679](http://www.hydrogeninsight.com/production/exclusive-worlds-largest-green-hydrogen-project-has-major-problems-due-to-its-chinese-electrolysers-bnef/2-1-1566679).
- CONCAWE, et al. *Well-To-Wheels Analysis of Future Automotive Fuels and Powertrains in the European Context Version 2c Version 2c*. 2008.
- Crownhart, Casey. "When Hydrogen Will Help Climate Change—and When It Won't." *MIT Technology Review*, 24 Feb. 2024, [www.technologyreview.com/2023/02/23/1069086/when-hydrogen-will-help-climate-change-and-when-it-wont/](http://www.technologyreview.com/2023/02/23/1069086/when-hydrogen-will-help-climate-change-and-when-it-wont/). Accessed 17 June 2024.
- DOE. "A History of Hydrogen Timeline Fact Sheet." *Mwcog.org*, 2021, [www.mwcog.org/file.aspx?&A=zkpV0NhzZDWLPqP7LLLYTPZMIgxuq1QGhT8%2BMkINPbo%3D](http://www.mwcog.org/file.aspx?&A=zkpV0NhzZDWLPqP7LLLYTPZMIgxuq1QGhT8%2BMkINPbo%3D).
- FuelCellsWorks. "Nine of the Largest Green Hydrogen Projects 2022 - FuelCellsWorks." *9 of the Largest Green Hydrogen Projects.*, 12 May 2022, [fuelcellsworks.com/news/nine-of-the-largest-green-hydrogen-projects-2022/](http://fuelcellsworks.com/news/nine-of-the-largest-green-hydrogen-projects-2022/).
- GeologyScience. "Platinum (Pt) Ore | Minerals, Formation, Occurrence, Deposits." *Geology Science*, 12 Apr. 2023, [geologyscience.com/ore-minerals/platinum-ore/](http://geologyscience.com/ore-minerals/platinum-ore/).
- Grubb, W. T. "Ionic Migration in Ion-Exchange Membranes." *The Journal of Physical Chemistry*, vol. 63, no. 1, Jan. 1959, pp. 55–58, <https://doi.org/10.1021/j150571a015>. Accessed 28 Mar. 2023.
- Holton, Oliver T., and Joseph W. Stevenson. "The Role of Platinum in Proton Exchange Membrane Fuel Cells." *Platinum Metals Review*, vol. 57, no. 4, 1 Oct. 2013, pp. 259–271, <https://doi.org/10.1595/147106713x671222>. Accessed 20 Oct. 2020.
- Howarth, Robert W., and Mark Z. Jacobson. "How Green Is Blue Hydrogen?" *Energy Science & Engineering*, vol. 9, no. 10, 12 Aug. 2021, [onlinelibrary.wiley.com/doi/full/10.1002/ese3.956](http://onlinelibrary.wiley.com/doi/full/10.1002/ese3.956), <https://doi.org/10.1002/ese3.956>.
- "Hydrogen Gas Supplier | Liquid Hydrogen | Air Products." *Www.airproducts.com*, [www.airproducts.com/gases/hydrogen](http://www.airproducts.com/gases/hydrogen).
- Jaouen, Frédéric, et al. "Toward Platinum Group Metal-Free Catalysts for Hydrogen/Air Proton-Exchange Membrane Fuel Cells." *Johnson Matthey Technology Review*, vol. 62,

- no. 2, 1 Apr. 2018, pp. 231–255, <https://doi.org/10.1595/205651318x696828>. Accessed 17 Nov. 2020.
- L, Jennifer. “DOE Sets Eyes on Cutting Clean Hydrogen Cost, \$1/Kilo by 2031.” *Carbon Credits*, 10 May 2024, [carboncredits.com/doe-sets-eyes-on-cutting-clean-hydrogen-cost-1-kilo-by-2031/#:~:text=The%20DOE%20aims%20to%20significantly](https://carboncredits.com/doe-sets-eyes-on-cutting-clean-hydrogen-cost-1-kilo-by-2031/#:~:text=The%20DOE%20aims%20to%20significantly). Accessed 17 June 2024.
- Lindsey, Rebecca. “Climate Change: Annual Greenhouse Gas Index | NOAA Climate.gov.” *Climate.gov*, 17 June 2022, [www.climate.gov/news-features/understanding-climate/climate-change-annual-greenhouse-gas-index](https://www.climate.gov/news-features/understanding-climate/climate-change-annual-greenhouse-gas-index).
- . “Climate Change: Atmospheric Carbon Dioxide.” *Climate.gov*, NOAA, 9 Apr. 2024, [www.climate.gov/news-features/understanding-climate/climate-change-atmospheric-carbon-dioxide](https://www.climate.gov/news-features/understanding-climate/climate-change-atmospheric-carbon-dioxide).
- Lindsey, Rebecca, and Luann Dahlman. “Climate Change: Global Temperature.” *Climate.gov*, NOAA, 18 Jan. 2024, [www.climate.gov/news-features/understanding-climate/climate-change-global-temperature](https://www.climate.gov/news-features/understanding-climate/climate-change-global-temperature).
- Matthey, Johnson. ““*The Fuel Cell Industry Review 2012*. ”” *Platinum Metals Review*, vol. 56, no. 4, 1 Oct. 2012, pp. 272–273, <https://doi.org/10.1595/147106712x657535>. Accessed 10 Aug. 2022.
- “MineralsUK | the British Geological Survey’s Centre for Sustainable Mineral Development.” *www2.Bgs.ac.uk*, [www2.bgs.ac.uk/mineralsuk/home.html?\\_ga=2.72835610.860442341.1712925766-715231059.1712925766](https://www2.bgs.ac.uk/mineralsuk/home.html?_ga=2.72835610.860442341.1712925766-715231059.1712925766). Accessed 17 June 2024.
- Moreira, Susana , and Tim Laing. “Sufficiency, Sustainability, and Circularity of Critical Materials for Clean Hydrogen.” *Hydrogen Council*, 14 Dec. 2022, [hydrogencouncil.com/en/sufficiency-sustainability-and-circularity-of-critical-materials-for-clean-hydrogen/](https://hydrogencouncil.com/en/sufficiency-sustainability-and-circularity-of-critical-materials-for-clean-hydrogen/). Accessed 17 June 2024.
- Mungall, J. E., and A. J. Naldrett. “Ore Deposits of the Platinum-Group Elements.” *Elements*, vol. 4, no. 4, 1 Aug. 2008, pp. 253–258, <https://doi.org/10.2113/gselements.4.4.253>. Accessed 17 June 2019.
- N. E., Idoine. *World Mineral Production*. 2018.
- NEOM. “NGHC - NEOM Green Hydrogen Company.” *NGHC*, May 2024, [nghc.com](https://nghc.com). Accessed 17 June 2024.
- Price, F. “Scoping Report on the Material Requirements for a UK Hydrogen Economy.” *British Geological Survey*, 21 June 2023, [www.bgs.ac.uk/news/scoping-report-on-the-material-requirements-for-a-uk-hydrogen-economy/#:~:text=Given%20the%20targets%20the%20UK](https://www.bgs.ac.uk/news/scoping-report-on-the-material-requirements-for-a-uk-hydrogen-economy/#:~:text=Given%20the%20targets%20the%20UK). Accessed 17 June 2024.

- Reverdiau, Geoffrey, et al. “Will There Be Enough Platinum for a Large Deployment of Fuel Cell Electric Vehicles?” *International Journal of Hydrogen Energy*, vol. 46, no. 79, Nov. 2021, pp. 39195–39207, <https://doi.org/10.1016/j.ijhydene.2021.09.149>.
- Sawada, S., et al. “Solid Polymer Electrolyte Water Electrolysis Systems for Hydrogen Production Based on Our Newly Developed Membranes, Part I: Analysis of Voltage–Current Characteristics.” *Progress in Nuclear Energy*, vol. 50, no. 2-6, Mar. 2008, pp. 443–448, <https://doi.org/10.1016/j.pnucene.2007.11.029>.
- UKTreasury. “UK and U.S. To Clamp down Harder on the Trade of Russian Metals.” *GOV.UK*, 12 Apr. 2024, [www.gov.uk/government/news/uk-and-us-to-clamp-down-harder-on-the-trade-of-russian-metals](http://www.gov.uk/government/news/uk-and-us-to-clamp-down-harder-on-the-trade-of-russian-metals).
- WorldBank. “Sufficiency, Sustainability, and Circularity of Critical Materials for Clean Hydrogen.” *World Bank*, 2022, [www.worldbank.org/en/topic/energy/publication/sufficiency-sustainability-and-circularity-of-critical-materials-for-clean-hydrogen](http://www.worldbank.org/en/topic/energy/publication/sufficiency-sustainability-and-circularity-of-critical-materials-for-clean-hydrogen).

# Can We Predict Ozone Loss from Wildfires Using Satellite Products?

Asura, Xinyu Tian

## Abstract

Stratospheric ozone is so important that it protects life on Earth from ultraviolet light. However, aerosols and ozone-depleting substances released by wildfires reduce stratospheric ozone levels, which in turn affects life on Earth. The 2019/2020 Australian wildfires lasted for six months (started in September 2019 and burned until February 2020). Here, I compare NASA's Aura Microwave Limb Sounder (MLS) and MERRA-2 reanalysis records for 2017, 2018, 2019, and 2020. Shortly after increased levels of carbon monoxide were observed, MERRA-2 reanalysis showed much lower levels of stratospheric ozone in 2020 than in 2017-2019. Carbon monoxide can be used as an indicator for predicting lower stratospheric ozone, i.e., the level of carbon monoxide rises and the concentration of ozone in the stratosphere falls. Therefore, satellites can be used to estimate changes in ozone levels by measuring changes in the concentration of carbon monoxide in the atmosphere or the stratosphere.

Keywords Ozone depletion · Carbon monoxide · Australian Wildfires · Satellite products

## 1. Introduction

People care about the stratospheric ozone layer because it blocks UV radiation from the Sun which protects life on the Earth. Stratospheric ozone depletion has implications for the health of humans, animals, and plants. Reduced stratospheric ozone levels can lead to an increase in skin diseases, cataracts, and a reduction in the capacity of the immune system. UV radiation negatively impacts the bioactivity of organisms, and the ability of plants to photosynthesize and may lead to genetic mutation or recombination in plants. For example, the UV-B radiation affects the photosynthesis of phytoplankton. Phytoplankton are active in the euphotic zone, which is the most vulnerable zone to UV-B radiation, resulting in reduced survival of phytoplankton and other microorganisms. The reduction of phytoplankton and other microorganisms due to increased UV radiation will affect the entire marine food chain and even the food web (Heggin, 2022).

Numerous studies have pointed out that wildfires destroy the stratospheric ozone layer by releasing water and aerosols (Salawitch, 2022) , (Bernath, Peter F., et al., 2022). The presence of water and aerosols from wildfires can directly or indirectly cause ozone loss. However, ozone loss due to the emitting of particles and pollutants such as CFCs that are released into the atmosphere can cause big problems. For CFCs, they introduce chlorine into the stratosphere. When chlorine is in the atmosphere, it can combine an oxygen atom which is within an ozone molecule:  $O_3 + Cl \rightarrow ClO + O_2$ . Then chlorine will attach an oxygen atom to produce a new chlorine molecule again:  $O + ClO \rightarrow Cl + O_2$ . In this process, a single chlorine atom acts as a catalyst and can break down about 100,000 ozone molecules per chlorine atom (Friedland, Andrew, and Rick Relyea, 2015). Wildfires emit smoke and aerosol precursors which will provide a surface on which chemical reactions can happen. The particles convert reservoir chlorine to active chlorine that catalytically destroys ozone, which is the process same as CFCs

destroy the ozone process. (Allen, Bob, 2017). These deep-convective events inject wildfire emissions and tropospheric directly into the stratosphere. The injection of moist and ozone-depleted air causes a reduction in stratospheric ozone. Wildfires will also inject aerosols and form pyro-cumulonimbus clouds (pyroCb). They are explosive storm clouds formed by smoke and heat from wildfires, often rising into the upper troposphere or lower stratosphere (Glossary of Meteorology, 2021). This property allows them to inject smoke and aerosols into the lower stratosphere during wildfires, and a single pyroCb can inject particles such as dust up to 10 miles into the lower stratosphere and drift for over a year (Brian Dunbar, and Bob Allen, 2023). The particles convert reservoir chlorine to active chlorine that catalytically destroys ozone, which is the process same as CFCs destroy the ozone process.

The 2019-20 Australian wildfires (ANY) began in September 2019 and burned until February 2020. Peak fire activity occurred between December 2019 and January 2020. By 7 January 2020, the smoke travelled approximately 12,000 km across the South Pacific Ocean to Chile and Argentina (SBS News, 2020). Pyro-cumulonimbus (pyroCb) deep convective events were observed over the ANY fires. Hence, many studies have focused on the problem of the relationships between ozone depletion and wildfires (Salawitch, 2022) · (Bernath, Peter F., et al., 2022) · (Yu, Pengfei, et al., 2021) · (Santee, M. L., et al., 2021).

\ While there has been some research on forest wildfires that has focused on the effects of nitrogen oxides, and chlorine-containing compounds on changes in stratospheric ozone levels, few researchers have considered predictions of ozone depletion from remote sensing of fire activity proxies like carbon monoxide (CO). I seek to lay the groundwork for predicting ozone depletion in advance through satellite measurements of CO levels in the atmosphere. My research will allow for the use of satellites to predict future ozone reductions.

## **2. Results**

During the 2019-20 Australian Wildfires, it emits a lot of CO into the atmosphere. As can be seen in Figure 1, between late 2019 and early 2020, in the southern hemisphere mid-latitude (between 20°S and 60°S) region at a pressure of 100 hPa, there was a large increase in stratospheric carbon monoxide levels due to the Australian wildfires.

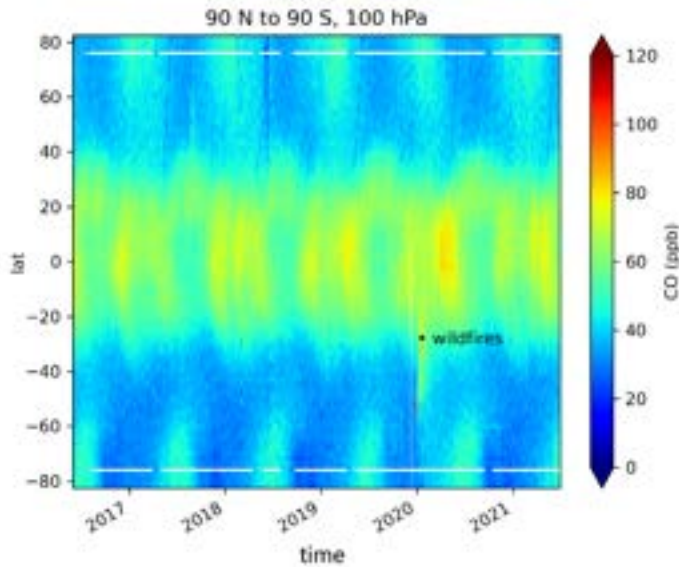

Figure 1. The CO concentration between 2017 to 2021 and the 2019/2020 Australian wildfire (30°S).

As can be seen in Figure 2, around September 2019, carbon monoxide emissions exceeded 2017, 2018, and 2020. From September 2019, CO started rising. This is consistent with the September 2019 start of the Australian wildfires. Carbon monoxide emissions peaked in early 2020 (from December 2019 to January 2020), which is consistent with the carbon monoxide massive January peak. At the January peak in 2020, wildfire emissions of carbon monoxide were 27.45% higher than the average of 2017, 2018, and 2019. Then, the carbon monoxide emissions in 2020 slowly declined.

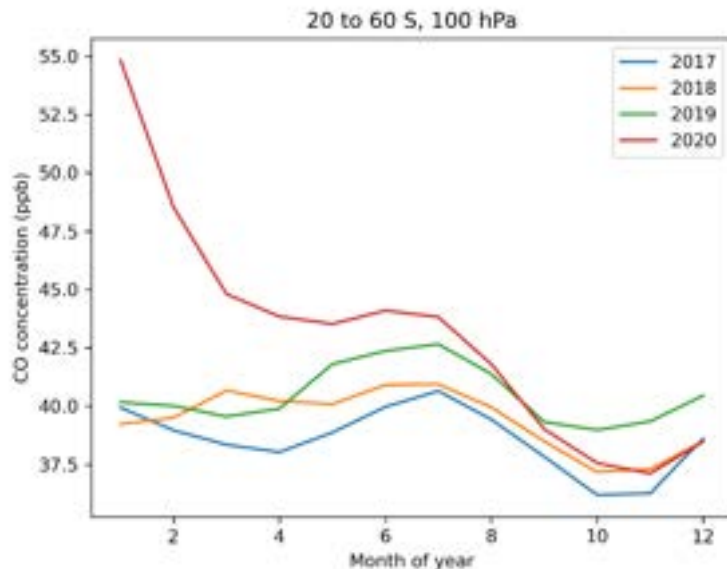

Figure 2. Carbon monoxide concentrations at mid-latitudes (20°S to 60°S).

Shortly after the CO enhancement, MERRA-2 reanalysis displays southern hemisphere midlatitude and polar ozone depletion (Figure 2). Because aerosols and other ozone-depleting



substances emitted by wildfires do not destroy ozone immediately, the reduction in stratospheric ozone levels would follow a drastic change in carbon monoxide levels.

As can be seen in Figure 3, stratospheric ozone declines in the late 2020 to the beginning of 2021. It can also be seen from Figure 4 that ozone levels in the stratosphere (50 hPa) from 20°S to 60°S begin to decline after October 2019, resulting in a decrease in total ozone levels in 2020.

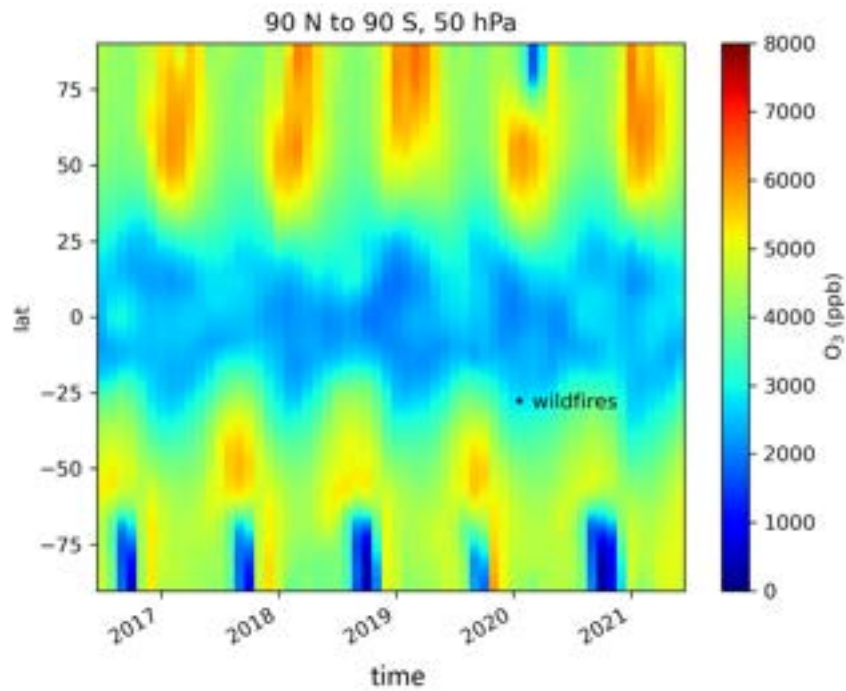
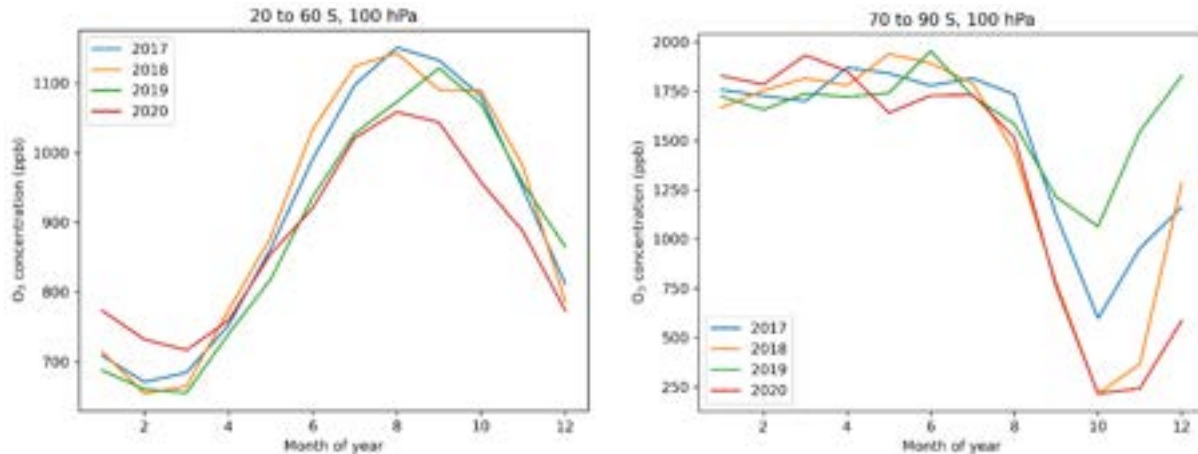

Figure 3. The Ozone concentration between 2017 to 2021 and the 2019/2020 Australian wildfire (30°S).

For stratospheric ozone levels in the mid-latitudes (Figure 4.a), overall ozone levels in 2020 are lower than in 2017, 2018 and 2019 due to the 2019-20 Australian wildfires' large emissions of aerosols and particles that destroyed the ozone layer.



**Figure 4. (a)** Ozone concentrations at mid-latitudes (30°S to 60°S). **(b)** Ozone concentrations at polar region(70°S to 90°S).

Figure 4.b shows that ozone levels in the polar region at 100 hPa in all four years, 2017, 2018, 2019 and 2020, start to decline around August. This is due to the fact that ozone levels decline every spring (from around August to around November) in the Southern Hemisphere.

Figures 4.a and 4.b show that around August, atmospheric ozone concentrations decrease not only in the polar regions but also in the mid-latitudes. This is due not only to the large amount of ozone-depleting substances emitted into the atmosphere by the Australian wildfires but also to the fact that ozone-depleting air over the polar regions spreads away from the poles during and after each winter and spring seasons, thus reducing average ozone at non-polar latitudes.

### 3. Discussion

Large wildfires, such as ANY, inject large amounts of aerosols and other ozone-depleting substances resulting in stratospheric ozone depletion that contributed to ozone levels in 2020 that were lower than in 2017-2019. Due to the complex nature of wildfire emissions to the stratosphere, a proxy for fire emission to the stratosphere, such as CO, would allow for useful predictive capabilities. However, the increase in stratospheric CO levels at mid-latitudes indicates that CO emissions peaked in mid-January 2020 (Figure 2), and a decrease in stratospheric ozone levels in 2020 was detected by MERRA-2 reanalysis shortly thereafter. This means that an increase in CO concentration means a decrease in ozone concentration, and vice versa. From the above statement, we were able to predict changes in ozone levels in the atmosphere -- particularly in the stratosphere -- from the levels of carbon monoxide released by the Australian wildfires.

The case study of the 2019-20 Australian wildfires and the analysis of data from NASA's Aura Microwave Limb Sounder (MLS) and MERRA-2 reanalysis demonstrates that satellites can be used to predict stratospheric ozone loss after or during wildfires from stratospheric carbon monoxide levels. Wildfires emit many ozone-depleting substances into the stratosphere, as well

as carbon monoxide into the atmosphere. When carbon monoxide concentrations increase at the time of a wildfire, this is often indicative of a decline in stratospheric ozone concentrations at a later time. A decline in stratospheric ozone levels (which would lead to an increase in the intensity of UV radiation entering the atmosphere) can impact not only humans but also the biosphere as a whole. Therefore, predicting stratospheric ozone reduction by detecting carbon monoxide concentrations emitted by wildfires and analysing the catastrophe would be beneficial to the entire biosphere.

In this study, I demonstrated the possibility of using CO remote sensing as a proxy for wildfire emission to the stratosphere to predict future reductions in ozone levels. I will look into some research and keep an eye on the ongoing news of satellites predicting ozone to advance my research. I will also collect more data, especially expand my data period, to get more data to analyse. My experiment will fill the gap in atmospheric chemistry in terms of predicting ozone reduction from satellite data, which will be more conducive for people to take precautionary measures based on the predicted ozone reduction, which will contribute to the health of human beings as well as the stability of the ecosystem.

#### **4. Data and Methods**

My database is derived from satellite databases published by the National Aeronautics and Space Administration (NASA). I use the CO database from the Aura MLS measurements. Specifically, I primarily use the CO database from the Aura MLS measurements and the ozone database from the MERRA-2 reanalysis. These data were captured by NASA's Aura satellite between 2016 and 2021. I filtered the database data to focus on changes in stratospheric levels of carbon monoxide and ozone in the region between 30°S and 60°S and the polar regions.

The CO data is and is filtered according to the recommendations put forth in the MLS Aura Version 5.0x Level 2 and 3 data quality and description document. Version 5.0x features of the CO database are centred on the upper mesosphere, and the difference in a priori accuracy between v5.0x CO and v4.2x is smaller (1.5 times larger at 0.046 hPa, 1.5 times larger at 0.01 hPa, and 2 times larger at 0.01 hPa). Horizontal smoothing has been improved in v5.0x at and above 0.01 hPa to maintain the stability of the retrieval. In addition, the vertical range of the search has been extended to 0.00046 hPa (Livesey, N. J., et al., 2008) (Pumphrey, H. C., et al., 2007)

Level 4 MERRA-2 data were used for stratospheric ozone concentrations. MERRA-2 is an intermediate reanalysis (reanalysis is the process of reprocessing meteorological data using a data system) that improves upon MERRA, where aerosol data assimilation, the representation of ozone, and the use of precipitation observations. In particular, aerosol data assimilation, the representation of ozone, and on the use of precipitation observations to force the land surface have successfully provided multidecadal reanalysis for the global data assimilation system (Gelaro, Ronald, et al., 2017).

#### **5. Acknowledgments**

I would like to give special thanks to my supervisor: Corey Pedersen. He has helped me a lot by providing me with databases, finding papers that fit my topic, and helping me gain a deeper understanding of the subject matter. This research would not have been possible without my supervisor, Corey Pedersen. Thank you again for your help!

## Works Cited

- Allen, Bob. "Atmospheric Aerosols: What Are They, and Why Are They so Important?" *NASA*, 7 Aug. 2017, [www.nasa.gov/centers/langley/news/factsheets/Aerosols.html#:~:text=The%20interaction%20of%20chemicals%20on%20the%20surface%20of,is%20a%20prime%20contributor%20to%20stratospheric%20ozone%20destruction](http://www.nasa.gov/centers/langley/news/factsheets/Aerosols.html#:~:text=The%20interaction%20of%20chemicals%20on%20the%20surface%20of,is%20a%20prime%20contributor%20to%20stratospheric%20ozone%20destruction). Accessed 25 Aug. 2023.
- Bernath, Peter F., et al. "Wildfire Smoke Destroys Stratospheric Ozone." *Science*, vol. 375, no. 6586, American Association for the Advancement of Science, Mar. 2022, pp. 1292–95, doi:10.1126/science.abm5611.
- Brian Dunbar, and Bob Allen. "NASA - Fire-Breathing Storm Systems." *NASA*, 19 Oct. 2010, [www.nasa.gov/topics/earth/features/pyrocb.html](http://www.nasa.gov/topics/earth/features/pyrocb.html). Accessed 25 Aug. 2023.
- Chu, Jennifer. "Study: Smoke Particles From Wildfires Can Erode the Ozone Layer." *Phys.org*, MIT News, 8 Mar. 2023, [phys.org/news/2023-03-particles-wildfires-erode-ozone-layer.html#:~:text=A%20wildfire%20can%20pump%20smoke%20up%20into%20the,the%20Earth%20from%20the%20sun%27s%20damaging%20ultraviolet%20radiation](https://phys.org/news/2023-03-particles-wildfires-erode-ozone-layer.html#:~:text=A%20wildfire%20can%20pump%20smoke%20up%20into%20the,the%20Earth%20from%20the%20sun%27s%20damaging%20ultraviolet%20radiation). Accessed 25 Aug. 2023.
- Friedland, Andrew, and Rick Relyea. "Stratospheric Ozone Depletion." *Environmental Science for AP®*, 2nd ed., New York, United States of America, Macmillan Higher Education, 2015, pp. 538–40.
- Gelaro, Ronald, et al. "The Modern-Era Retrospective Analysis for Research and Applications, Version 2 (MERRA-2)." *Journal of Climate*, vol. 30, no. 14, American Meteorological Society, July 2017, pp. 5419–54, doi:10.1175/jcli-d-16-0758.1.
- Hegglin, Michaela I. "Health and Environmental Effects of Ozone Layer Depletion | US EPA." *US EPA*, 27 Sept. 2022, [www.epa.gov/ozone-layer-protection/health-and-environmental-effects-ozone-layer-depletion](http://www.epa.gov/ozone-layer-protection/health-and-environmental-effects-ozone-layer-depletion). Accessed 23 Aug. 2023.
- Livesey, N. J., et al. "Validation of Aura Microwave Limb Sounder O<sub>3</sub> and CO Observations in the Upper Troposphere and Lower Stratosphere." *Journal of Geophysical Research*, vol. 113, no. D15, American Geophysical Union, Mar. 2008, doi:10.1029/2007jd008805.
- Pumphrey, H. C., et al. "Validation of Middle-atmosphere Carbon Monoxide Retrievals From the Microwave Limb Sounder on Aura." *Journal of Geophysical Research*, vol. 112, no. D24, American Geophysical Union, Dec. 2007, doi:10.1029/2007jd008723.
- "Pyrocumulonimbus - Glossary of Meteorology." *Glossary of Meteorology*, 1 Mar. 2021, [glossary.ametsoc.org/wiki/Pyrocumulonimbus](http://glossary.ametsoc.org/wiki/Pyrocumulonimbus). Accessed 25 Aug. 2023.
- Salawitch, R. J., and L. McBride. "Australian Wildfires Depleted the Ozone Layer." *Science*, vol. 378, no. 6622, American Association for the Advancement of Science, Nov. 2022, pp. 829–30, doi:10.1126/science.add2056.
- Santee, M. L., et al. "Prolonged and Pervasive Perturbations in the Composition of the Southern Hemisphere Midlatitude Lower Stratosphere From the Australian New Year's Fires."

*Geophysical Research Letters*, vol. 49, no. 4, American Geophysical Union, Feb. 2022, doi:10.1029/2021gl096270.

SBS News. “Australia Bushfire Smoke Travels 12,000 Kms to Chile.” *SBS News*, Jan. 2020, [www.sbs.com.au/news/dateline/article/australia-bushfire-smoke-travels-12-000-kms-to-chile/7zzmpw2k2](http://www.sbs.com.au/news/dateline/article/australia-bushfire-smoke-travels-12-000-kms-to-chile/7zzmpw2k2).

Yu, Pengfei, et al. “Persistent Stratospheric Warming Due to 2019–2020 Australian Wildfire Smoke.” *Geophysical Research Letters*, vol. 48, no. 7, American Geophysical Union, Apr. 2021, doi:10.1029/2021gl092609.

## Force Lab by Nandini Kolli, Kelley Ann Bethoney

### Abstract

This research explores how athletes from different sports apply contrasting amounts of force while completing three of the same movements. The procedure used in this study relies on the Vernier Go Direct Hand Dynamometer, which is used to calculate the grip strength/force that the athletes showed while completing all three movements. The major results of the study showed that athletes who played tennis exhibited higher force than athletes in squash and ping pong. In conclusion, the research strives to expand on how class 3 levers show the wide range of motion athletes can demonstrate while playing their respective sports.

### Introduction

The purpose of this research is to understand how force is exerted on certain arm groups while athletes perform specific movements of their sport. The lab is carried out by 9 student-athletes who participate in sports such as ping pong, tennis, and squash. Each student-athlete will complete the same series of motions: up and down, starting from the side of the body and completing the motion up and over the opposite shoulder, and having the arm start straight up and finish the motion by the opposite leg. As the students complete these motions, they will be holding a Vernier Go Direct Hand Dynamometer with the same force as they would hold their racquets, paddles, etc. The hand dynamometer can measure grip strength and pinch strength by holding the sensor in a vertical position. The strength can be measured by applying pressure for a series of short time periods (*Learning Visualized with the Vernier Go Direct Hand Dynamometer*) The force applied will differ based on each sport due to the differing levels of pressure they apply to their respective apparatus. The movements the student-athletes will complete in this lab are class 3 levers. Class 3 levers are defined as where the fulcrum is on one end and the force is applied to the middle and the weight is on the other end (“Types Of Lever - Examples, Mechanism, Application, Definition”). In this lab, the fulcrum is the elbow, the force is what will be calculated when the students complete the motions, and the weight is the hand dynamometer.

### Methods and Materials

Vernier Go Direct Hand Dynamometer (1), iPhone (1), Vernier Graphical Analysis Software (1), Notebook (1), Pencil (1), Calculator (1)

To start, download Vernier Graphical Analysis Software on iPhone. Charge Vernier Hand Dynamometer for 2 hours before collecting data. Once charged, turn on the dynamometer and press the Bluetooth button. When the button blinks red, connect to the iPhone on Vernier Graphical Analysis Software. Open a New Experiment and ask the participant to hold the hand dynamometer the same way and with the same grip they would hold their respective apparatus in their sport. Give the hand dynamometer to participate and ask them to complete Movement 1 (up and down). Start the timer for 15 seconds and press collect on the Vernier Graphical Analysis

Software app to start collecting data. Once 15 seconds pass, press stop on app and save the graph to files. Ask the participant to complete Movement 2 (starting from the side of the body and finishing over the opposite shoulder. Start the timer for 15 seconds and press collect on the Vernier Graphical Analysis Software app. Once 15 seconds pass, press stop on the app and save graph to files. Ask participant to complete Movement 3 (have arm start straight up and finish movement by opposite leg). Start timer for 15 seconds and press collect on Vernier Graphical Analysis app. Once 15 seconds pass, press stop on app and save graph to files. Repeat procedure for each participant for their respective sport. After collecting data, review each graph and for each movement and write down in notebook the force (in newtons) for 1-10 seconds. After, it is written down collect the average of the force for the movement. Repeat step for all other movements for other sports.

Table 1. Average Force (N) for Squash from Three Athletes for Three Movements

Participants	Average: Up and Down (N)	Average: Side to Down (N)	Average: Up to Down (N)
Individual 1	2.52	5.04	4.9
Individual 2	3.34	6.22	6.54
Individual 3	21.29	12.04	15.82

Table 2. Average Force (N) for Tennis from Three Athletes for Three Movements

Participants	Average: Up and Down (N)	Average: Side to Down (N)	Average: Side to Down (N)
Individual 1	42.5	41.34	35.32
Individual 2	19.25	22.31	17.08
Individual 3	9.32	11.1	10.74

Table 3. Average Force (N) for Ping Pong from Three Athletes for Three Movements



Participant	Average: Up and Down (N)	Average: Side to Down (N)	Average: Side to Down (N)
Individual 1	12.95	16.8	15.94
Individual 2	13.07	-0.04	0.26
Individual 3	4.53	9.96	7.7

Chart 1. Graph of Average Force Calculated for Three Movements in Squash, Tennis, and Ping Pong.

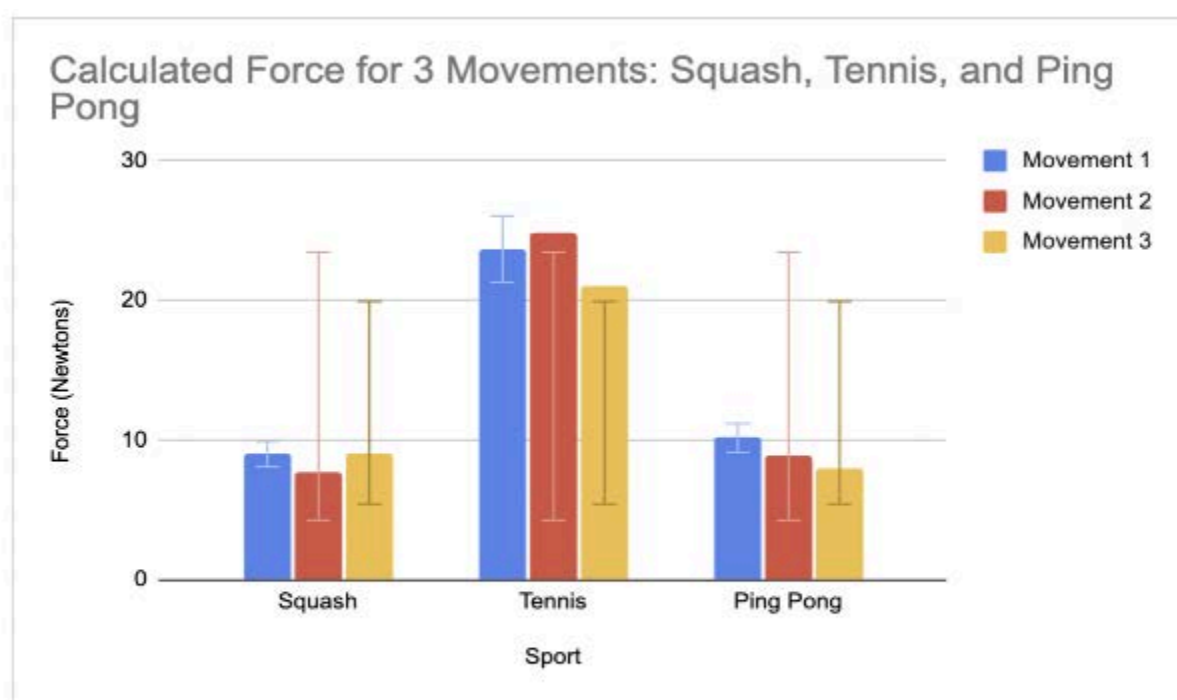

Figure 1. Vernier Graphical Analysis Graph for Movement 1

Figure 1. Vernier Graphical Analysis Graph for Movement 1

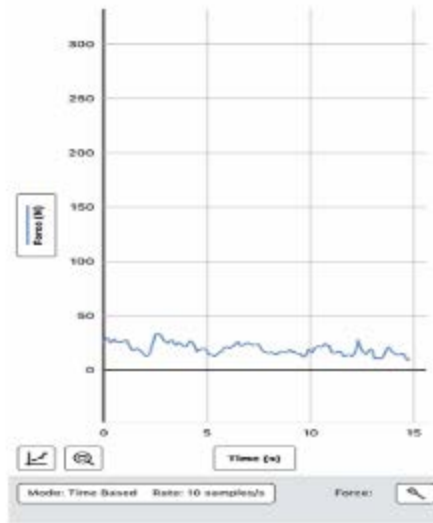

Figure 2. Vernier Graphical Analysis Graph for Movement 2

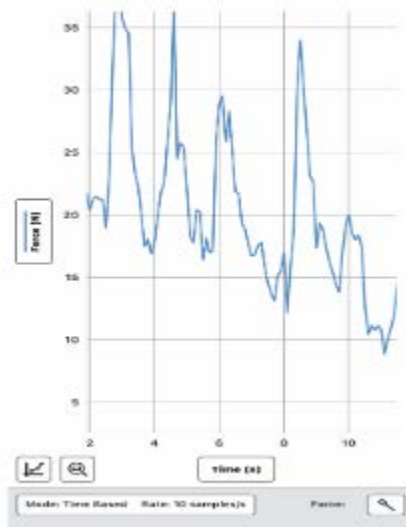
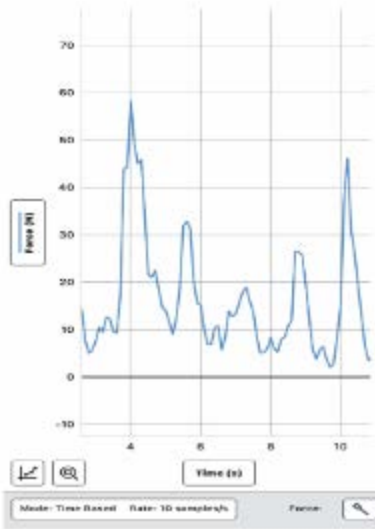

Figure 3. Vernier Graphical Analysis Graph for Movement 3



## Results

For movement 1 (up and down), the data showed that the average for squash had the lowest force(N) among the averages for tennis and ping pong. The average force recorded for squash was recorded at 9.01 N, while the average for tennis was 23.69 N, and ping pong was at 10.18 N. For movement 2 (starting from the side of the body and finishing over the opposite shoulder), similarly, for movement 1, tennis has the highest force compared to squash and ping pong, with ping pong being the second highest. The average force recorded for tennis in movement 2 was 24.91 N, ping pong at 8.9 N, and squash having an average force of 7.76 N. For movement 3 (arm starting straight up and finishing by the opposite leg, tennis once again had the highest overall average force recorded at 21.04 N. Contrastingly, squash has the second highest average force for movement two which was 9.08 N. Leaving ping pong with an average force of 7.96 N for movement 2.

## Discussion/Conclusion

The results of my lab showed a clear distinction between the average force calculated in tennis compared to ping pong and squash. For all three movements, tennis had the highest calculated average force overall. For Movements 1 and 2, the average calculated force was tennis, ping pong, and squash. However, for Movement 3, squash had a higher average calculated force than ping pong. The results do not align with the assumption that tennis and squash have similar average forces compared to ping pong. Squash and tennis have similar apparatus and use the same movements in their sport. Additionally, a ping pong paddle does not require much force or grip strength because the ping pong ball is very light compared to a tennis ball or a squash ball, leading to the assumption that the data collected for ping pong is faulty. Furthermore, each movement was designed to portray a change in the average force calculated. The force was calculated using Newton's which measures acceleration, mass, and speed

(“Newton Unit | Overview, Conversion & Examples - Lesson.”). For example, Movement 1 is not likely to have a higher calculated force than Movements 2 and 3 in the case of Squash because Movements 2 and 3 should require more force as the individual is moving their arms from up to down and vice versa. Overall, my data expressed the average calculated force for three sports for three movements. Although some data may be deemed to be imperfect the purpose of the lab was to understand how a Class 3 Lever is used by athletes performing specific movements of their sport which provides a larger understanding of how athletes are completing commonly disregarded motions while playing and providing them an in-depth explanation of how the force of the relationship between the fulcrum and load in a Class 3 lever describes the ability for a large range of movement with relatively low effort and how it alters based on different movements in different sports.

### Works Cited

*Learning Visualized with the Vernier Go Direct Hand Dynamometer* | NSTA.

<https://www.nsta.org/blog/learning-visualized-vernier-go-direct-hand-dynamometer>.

Accessed 23 May 2024.

“Types Of Lever - Examples, Mechanism, Application, Definition.” *BYJUS*,

<https://byjus.com/physics/types-of-lever/>. Accessed 23 May 2024.

“Newton Unit | Overview, Conversion & Examples - Lesson.” *Study.Com*,

<https://study.com/learn/lesson/newton-overview-measurement-unit-force.html>. Accessed

23 May 2024.

# **An Examination in the Components of Music as it Relates to the Efficacy of Music Therapy**

## **by Luke Xu**

### **Abstract**

Music therapy is a centuries-old technique used to treat a wide variety of disorders and diseases. Multiple studies have indicated the effectiveness of music therapy in alleviating symptoms while having virtually no observed adverse effects. Yet, little is known about the mechanisms that enable its function. Existing research has indicated that the perceived pleasantness of a piece of music affects an individual's psychological response to that music, so perhaps differences in the components of music will affect the success of music-based interventions. Therefore, this paper aims to identify how four components of music (rhythmicity, tempo, genre, and lyrical content) contribute to the efficacy of music therapy. We postulate that changing these parameters would likely affect the efficacy of musical interventions. The best choice of repertoire may vary and should be adapted to best suit each specific patient's needs. Ultimately, additional research must be conducted regarding music selection to maximize the efficacy of music therapy.

### **Introduction**

Music therapy (MT) has been around for millennia and has demonstrated its strength as an extremely powerful tool for treating patients with various neurological and psychological diseases (Kamioka et al.; Thaut). The Egyptians first wrote about the healing properties of music in 1500 BC (O'Kelly). Later, the ancient Greek connected music and its influence upon a person's character and manners; up to and through the Middle Ages, Greek theories continued to dominate the practice of medicine (Thaut). Although today's rapidly evolving technology-based world has completely reshaped the scientific community's approach to healthcare and treatment, music continues to play a crucial role in supplementing existing treatment plans. In its current form, music therapy is the clinical use of music-based interventions, alone or in conjunction with pharmacological interventions, to achieve the treatment or mitigation of symptoms ("What Is Music Therapy?"; Giovagnoli et al.). Multiple studies have indicated the effectiveness of MT in improving a wide variety of symptoms in patients with brain disorders, such as depressive symptoms, gait issues in Parkinson's disease, and social functioning in schizophrenia, all while having little to no observed adverse effects or rejection by patients (Kamioka et al.).

Yet, little is known about the mechanisms behind MT that make it so effective. Clements-Cortes and Bartel proposed a multi-layer approach to understanding the mechanisms of music therapy (Clements-Cortes and Bartel), where the largest and most dominant layer is the "learned cognitive response". This phenomenon suggests that an emotional response is associated with some piece of music as a learned response to cultural or societal influences (Clements-Cortes and Bartel). These emotional responses then activate the second layer, which acts on neural circuits (Clements-Cortes and Bartel). The neural circuits act on more neural circuits, comprising the third layer (Clements-Cortes and Bartel). Finally, the fourth layer

stimulates cellular-level responses (Clements-Cortes and Bartel). Research shows that the level of dissonance (perceived pleasantness) in music affects the levels of brain activity in different regions of the brain (Koelsch), indicating that the choice of music used during MT affects the individual's psychological response to that piece of music. So then a question remains: how does the choice of music presented to the patient during MT influence the outcome and efficacy of the treatment? In this review, we will examine how the different attributes of music contribute to the efficacy of music therapy treatment.

## **Results**

### **I. Rhythmicity and Tempo**

Rhythmicity is one of the most fundamental components of music that catches our attention and makes music possible (Honing; Levitin et al.). Rhythm is the ordered characteristic of succession in music, and tempo is the speed at which that music is performed (Casseday et al.). Three of the seven psychological mechanisms for the arousal of emotion in music listeners proposed by Juslin are directly influenced by rhythm and tempo (Juslin). Two are of note for their roles in MT: rhythmic entrainment, a gradual adjustment and synchronization of internal bodily rhythms towards an external rhythm, and musical expectancy, a reaction to musical structure and its expected repetition and continuation, or lack thereof (Juslin et al.; Juslin). The effects of rhythmic entrainment extend to the inferior colliculus (IC), where Tierney and Kraus demonstrated spikes in EEG activity in response to auditory stimuli in 124 tested high school students with normal hearing thresholds and brainstem responses (Tierney and Kraus). The IC is a major auditory hub of the brain that processes auditory signals and transmits/receives information to and from other parts of the brain, such as the cerebellum (Thaut et al.; Casseday et al.). The cerebellum acquires sensory information from pathways like the IC, and generates motor output; thus, rhythmic entrainment aids in sensorimotor synchronization tasks (Thaut et al.; Grahn et al.). Indeed, a trial conducted by Calabrò et al. combined rhythmic auditory stimulation (RAS), consisting of music superimposed with a high beat, with daily treadmill walking in 50 patients aged 62-81 years for 8 weeks (Calabrò et al.). Patients who underwent the treatment plan demonstrated higher scores for gait characteristics and self-confidence in walking ability compared to the control group, suggesting that patients with walking irregularities may benefit from RAS treatment (Calabrò et al.). However, a study conducted by Leow et al. showed that a RAS tempo unsuitable for the patient conversely decreased step stability (Leow et al.). Particularly, rhythmic stimuli create stable time scales for the brain to anticipate and use to prepare for movement (musical expectancy) (Thaut et al.). During the selection of music experiences, each individual patient's optimal "tempo" must be taken into consideration; if the patient is unable to follow along with or anticipate the beat, either because it is too fast, too slow, or is without a clear pulse, gait characteristics can worsen (Leow et al.; Calabrò et al.).

Music therapy may also play a major role in the treatment of Autism Spectrum Disorder (ASD). The primary effects of ASD are deficits in social communication, repetitive behaviors/restricted interests, and sensory deficits (Marquez-Garcia et al.; Berger). MT has been

shown to be superior to standard care and ‘placebo’ therapy in improving communication skills, behavior, and socio-emotional reciprocity for ASD patients (Geretsegger et al.), likely because MT recruits motor regions while listening to music (Chen et al.). Overy and Turner confirm that musical rhythm is not only interconnected with movement but also strongly related to language and its execution in speaking (Overy and Turner). In a study conducted by Kornysheva et al. of 18 healthy participants aged 22-29, fMRI imaging indicated that rhythmic stimuli improved premotor cortex activity if the tempo was at the speed the subjects preferred versus tempo that was not preferred (Bharathi et al.; Kornysheva et al.). This suggests that tempo may be an important attribute of music. Berger conducted an experiment with 6 ASD children aged 8-12 during which the subjects participated in rhythmic exercises with musical instruments at a tempo of 60 beats per minute (bpm) (Berger). Results from that study indicate that the slow tempo interventions were able to reduce anxiety and repetitive behaviors, likely because the slow tempo enables focus and calm in persons with ASD (Berger). The success of the results could have been different if the study was conducted with fast music that did not promote calmness because tempo affects arousal of the listener (Husain et al.). In addition to tempo, rhythmic entrainment can effectively aid in stimulating speech, motor, and language networks in ASD (Bharathi et al.), thereby suggesting that both rhythm and tempo play a large role in the effectiveness of MT. Entrainment is a critical component of communication but requires careful selection. Borrie and Liss conducted tests where 29 neurologically healthy individuals listened to pre-recorded sentences from either healthy controls or speakers with dysarthria, a motor speech disorder that results in slurred or stuttered speech and irregular volume (Borrie and Liss). They found that interactants modified their speaking to more closely align with the rate and pitch variations of the disordered speech (Borrie and Liss). In other words, the subjects’ speech worsened because it became more similar to the dysarthric speech. This suggests that an improper selection of musical attributes—for example, if the rhythmic or musical samples selected feature unstable rhythms or unsuitable tempo—could lead to worsening speech patterns.

Within RAS and music therapy, whether in Parkinson’s, Autism Spectrum Disorder, or any other brain disorder, rhythm and tempo must be carefully considered during the selection of music experiences. We see that rhythmicity and tempo affects the efficacy of music therapy, since a successful outcome relies on having a stable and salient rhythm of appropriate speed for the specific intervention.

## **II. Genre**

All music can be categorized into a genre, a broad grouping of traits such as style, form, or traditions. Depending on the traits of each genre, music can elicit different emotions in the listener, suggesting its possibility as a use for emotion regulation (Cook et al.) in emotional dysregulation disorders like anxiety. Anxiety can refer to a range of related phenomena, but one perspective defines it as an emotional state disorder caused by excessive worry, uncertainty/fear of the future, or an immediate perceived risk (Grupe and Nitschke; Abuse). Anxiety is further separated into two categories: state anxiety, a fleeting emotional state, and trait anxiety, which is



part of an individual's personality and usually underlies state anxiety (Farmer; Leal et al.). We will focus on state anxiety in this section because MT generally improves levels of state anxiety but not trait anxiety (Bahadir-Yilmaz; Biller et al.). Since music is a multipurpose coping strategy that can aid in regulating emotion and preventing the onset of anxiety (Farmer), perhaps the outcome of MT may be influenced by different musical genres. Kupeli and Gülnahar tested Turkish patients aged 18-30 who underwent wisdom teeth removal and found that between Western classical music, local cultural music, soft rock, and no music (control group), Western classical music was most effective in reducing dental anxiety (Kupeli and Gülnahar). This result suggests that specific genres of music appear to be more effective than others in producing the desired music intervention outcomes. However, Labbe et. al conducted a study of 56 persons of mostly Caucasian descent but some of African-American, Asian, or "other" ethnicity (Labbé et al.). They concluded that Western classical music does indeed reduce anxiety and promote relaxation, but so does music preferred by and chosen by the listener (Labbé et al.). The genre is likely not as important as the patient deeming the music to be relaxing and enjoyable. Indeed, a systematic review found that the genre and duration of music did not influence the effectiveness of music intervention in anxiety and pain reduction, so long as the music was soothing to the listener (Nilsson). Western classical music appears to be universally soothing (Diler Aydin; Trappe and Voit), which may explain its effectiveness in various studies regarding MT. However, these results still indicate that the influence of genre on MT effectiveness likely varies per patient because musical preference and emotional response to different genres of music are subjective (Yang et al.). Therefore, we suggest that doctors and researchers should select music based on their patients' genre preferences.

### **III. Lyrics**

Apart from musical elements, choosing music with lyrics may also convey meaning which may improve outcomes for patients after lyrical analysis intervention. The American Music Therapy Association (AMTA) defines lyric analysis (LA) as a psychosocial MT treatment used to assist patients in identifying personal issues, exploring emotions, and relating to the experiences of others (Miller). Multiple studies have implicated the effectiveness of LA in improving self-esteem and decreasing feelings of fear/distrust among patients with a variety of disorders and mental illnesses (Jurgensmeier; Silverman, "Effects of Lyric Analysis Interventions on Treatment Motivation in Patients on a Detoxification Unit: A Randomized Effectiveness Study"; Jones; Baker). According to a survey sent out to AMTA members who identified as having worked with patients in the "Mental Health" population, one of the rationales behind selecting a song was the issues presented within the lyrics of the songs (Silverman, "The Use of Lyric Analysis Interventions in Contemporary Psychiatric Music Therapy: Descriptive Results of Songs and Objectives for Clinical Practice"). Particularly, discussion around lyrics that resonated with patients may have helped them work through negative feelings or reinforced positive ones (Jones). A study also found that lyrics belonging to various genres of music differed in how likely that music was to inspire prosocial behavior (Ballard et al.). The feelings affected by LA

interventions may, therefore, vary depending on the topics contained within the lyrics of the selected repertoire. Furthermore, the music accompanying such lyrics also affects their interpretation (Thompson and Russo; Baker). Sung lyrics were judged to be more meaningful than spoken lyrics for familiar music (Thompson and Russo), indicating that the presence of musical elements influences and enhances the emotional response to lyrics. Music appears to add a secondary, deeper layer to the meaning and interpretation of lyrics; it adds emotional backing and heightens the climax/resolution of lyrics (Baker). It can also assist in decoding the lyrical material by clarifying the emotion and intention of the lyrics through elements like mood and key, or simply convey a message that words could not due to limitations in language (Baker). It is clear that the lyrical content and the musical accompaniment both work in tandem during lyrical analysis to treat patients' emotional states. Because variations in lyrics and music may produce different responses, the selection of repertoire could be tailored to address issues specific to each patient for maximum efficacy in treatment.

## **Discussion**

This research paper found that some aspects of music like rhythmicity and lyrics appeared to have a direct correlation with efficacy of music intervention treatment, while other aspects like genre had less effect. Our findings indicated that, overall, the selected repertoire should be adapted to suit the patient. During gait rehabilitation, the music should have a strong and stable beat at walking speed for the patient to follow, while anxiety reduction treatments should aim to place the patient in a relaxed and content state. In known MT treatments outside of those discussed in this paper, the same likely holds true. In pain relief, for example, the patients' preferred music helps distract them from pain (Hauck et al.). It should be noted, however, that in some cases music therapy cannot be the sole intervention used to alleviate symptoms (Yi et al.). A study evaluating the efficacy of depression treatment in abduction survivors found that while music therapy was successful in treatment of depression, cognitive behavioral therapy was nonetheless more effective in comparison (Yi et al.). For the more severe cases, MT interventions are best paired with an established pharmacological intervention to improve overall treatment results (Degli Stefani and Biasutti; Giovagnoli et al.). Although music therapy has already been established as an effective alternative treatment tool, few research studies have been conducted comparing different music selections during the intervention process. More research must be done to understand the mechanisms behind its function and how to better utilize MT to achieve desired effects, including what music to use, how best to administer it, and in which cases it can be used as a standalone treatment. Understanding how different aspects of music, such as rhythmicity, lyrics, genre, and tempo may affect MT intervention outcomes is the first step in designing future controlled studies on this topic.

## **Conclusion**

Music therapy is an age-old technique used to treat a variety of disorders and diseases with little to no side effects. It plays an important role in modern clinical treatments, yet only

recently have we started to understand the mechanisms behind which music therapy works and how to use it most effectively. An essential component of MT treatment is the music used within interventions, and this paper identifies several components of music that may affect MT treatment efficacy. Variations in a few components of music like rhythm, tempo, genre, and lyrical content appear to affect the efficacy of MT treatment. Understanding the components that affect MT is the first step to personalizing music therapy, enabling us to target each individual's needs.

## Works Cited

- Abuse, Substance. *Table 3.15, DSM-IV to DSM-5 Generalized Anxiety Disorder Comparison*. Substance Abuse and Mental Health Services Administration (US), 2016, <https://www.ncbi.nlm.nih.gov/books/NBK519704/table/ch3.t15/>.
- Bahadir-Yilmaz, Emel. "Effect of Executive Music Therapy on State and Trait Anxiety Levels of Patients in a Psychiatric Ward: A Quasi-Experimental Study." *Perspectives in Psychiatric Care*, vol. 57, no. 1, Jan. 2021, pp. 98–104, <https://doi.org/10.1111/ppc.12530>.
- Baker, Felicity A. "What about the Music? Music Therapists' Perspectives on the Role of Music in the Therapeutic Songwriting Process." *Psychology of Music*, vol. 43, no. 1, Jan. 2015, pp. 122–39, <https://doi.org/10.1177/0305735613498919>.
- Ballard, Mary E., et al. "Genre of Music and Lyrical Content: Expectation Effects." *The Journal of Genetic Psychology*, vol. 160, no. 4, Dec. 1999, pp. 476–87, <https://doi.org/10.1080/00221329909595560>.
- Berger, Dorita S. "Pilot Study Investigating the Efficacy of Tempo-Specific Rhythm Interventions in Music-Based Treatment Addressing Hyper-Arousal, Anxiety, System Pacing, and Redirection of Fight-or-Flight Fear Behaviors in Children with Autism Spectrum Disorder (ASD)." *Journal of Biomusical Engineering*, vol. 2, 2012, pp. 1–15, <https://doi.org/10.4303/jbe/m110902>.
- Bharathi, Geetha, et al. "The Potential Role of Rhythmic Entrainment and Music Therapy Intervention for Individuals with Autism Spectrum Disorders." *Journal of Exercise Rehabilitation*, vol. 15, no. 2, Apr. 2019, pp. 180–86, <https://doi.org/10.12965/jer.1836578.289>.
- Biller, J. D., et al. "The Effect of 'Happy' Versus 'Sad' Music and Participation on Anxiety12." *Journal of Music Therapy*, vol. 11, no. 2, July 1974, pp. 68–73, <https://doi.org/10.1093/jmt/11.2.68>.
- Borrie, Stephanie A., and Julie M. Liss. "Rhythm as a Coordinating Device: Entrainment with Disordered Speech." *Journal of Speech, Language, and Hearing Research: JSLHR*, vol. 57, no. 3, June 2014, pp. 815–24, [https://doi.org/10.1044/2014\\_JSLHR-S-13-0149](https://doi.org/10.1044/2014_JSLHR-S-13-0149).
- Calabrò, Rocco Salvatore, et al. "Walking to Your Right Music: A Randomized Controlled Trial on the Novel Use of Treadmill plus Music in Parkinson's Disease." *Journal of Neuroengineering and Rehabilitation*, vol. 16, no. 1, June 2019, p. 68, <https://doi.org/10.1186/s12984-019-0533-9>.
- Casseday, John H., et al. "The Inferior Colliculus: Past, Present, and Future." *The Inferior Colliculus*, edited by Jeffery A. Winer and Christoph E. Schreiner, Springer New York, 2005, pp. 626–40, [https://doi.org/10.1007/0-387-27083-3\\_22](https://doi.org/10.1007/0-387-27083-3_22).
- Chen, Joyce L., et al. "Listening to Musical Rhythms Recruits Motor Regions of the Brain." *Cerebral Cortex*, vol. 18, no. 12, Dec. 2008, pp. 2844–54, <https://doi.org/10.1093/cercor/bhn042>.
- Clements-Cortes, Amy, and Lee Bartel. "Are We Doing More Than We Know? Possible Mechanisms of Response to Music Therapy." *Frontiers of Medicine*, vol. 5, Sept. 2018, p.

- 405345, <https://doi.org/10.3389/fmed.2018.00255>.
- Cook, Terence, et al. "Music as an Emotion Regulation Strategy: An Examination of Genres of Music and Their Roles in Emotion Regulation." *Psychology of Music*, vol. 47, no. 1, Jan. 2019, pp. 144–54, <https://doi.org/10.1177/0305735617734627>.
- Degli Stefani, Mario, and Michele Biasutti. "Effects of Music Therapy on Drug Therapy of Adult Psychiatric Outpatients: A Pilot Randomized Controlled Study." *Frontiers in Psychology*, vol. 7, Oct. 2016, p. 1518, <https://doi.org/10.3389/fpsyg.2016.01518>.
- Diler Aydin, Suzan Yildiz. "Effect of Classical Music on Stress among Preterm Infants in a Neonatal Intensive Care Unit." *HealthMED*, vol. 6, no. 9, 2012, [https://www.researchgate.net/publication/286851898\\_Effect\\_of\\_classical\\_music\\_on\\_stress\\_among\\_preterm\\_infants\\_in\\_a\\_neonatal\\_intensive\\_care\\_unit](https://www.researchgate.net/publication/286851898_Effect_of_classical_music_on_stress_among_preterm_infants_in_a_neonatal_intensive_care_unit).
- Farmer, Savacia. *The Effects of Music Genre on Anxiety and Cognitive Task Performance*. 2020. Barry University, Master of Science, <https://www.proquest.com/openview/b46b0cc9e9326810ef9c188eefa76e72/>.
- Geretsegger, Monika, et al. "Music Therapy for People with Autism Spectrum Disorder." *Cochrane Database of Systematic Reviews*, vol. 2014, no. 6, June 2014, p. CD004381, <https://doi.org/10.1002/14651858.CD004381.pub3>.
- Giovagnoli, Anna Rita, et al. "Combining Drug and Music Therapy in Patients with Moderate Alzheimer's Disease: A Randomized Study." *Neurological Sciences: Official Journal of the Italian Neurological Society and of the Italian Society of Clinical Neurophysiology*, vol. 39, no. 6, Mar. 2018, pp. 1021–28, <https://doi.org/10.1007/s10072-018-3316-3>.
- Grahn, Jessica A., et al. "fMRI Investigation of Cross-Modal Interactions in Beat Perception: Audition Primes Vision, but Not Vice Versa." *NeuroImage*, vol. 54, no. 2, Jan. 2011, pp. 1231–43, <https://doi.org/10.1016/j.neuroimage.2010.09.033>.
- Grupe, Dan W., and Jack B. Nitschke. "Uncertainty and Anticipation in Anxiety: An Integrated Neurobiological and Psychological Perspective." *Nature Reviews. Neuroscience*, vol. 14, no. 7, July 2013, pp. 488–501, <https://doi.org/10.1038/nrn3524>.
- Hauck, Michael, et al. "The Influence of Music and Music Therapy on Pain-Induced Neuronal Oscillations Measured by Magnetencephalography." *Pain*, vol. 154, no. 4, Apr. 2013, pp. 539–47, <https://doi.org/10.1016/j.pain.2012.12.016>.
- Honing, Henkjan. "Without It No Music: Beat Induction as a Fundamental Musical Trait." *Annals of the New York Academy of Sciences*, vol. 1252, Apr. 2012, pp. 85–91, <https://doi.org/10.1111/j.1749-6632.2011.06402.x>.
- Husain, Gabriela, et al. "Effects of Musical Tempo and Mode on Arousal, Mood, and Spatial Abilities." *Music Perception*, vol. 20, no. 2, Dec. 2002, pp. 151–71, <https://doi.org/10.1525/mp.2002.20.2.151>.
- Jones, Jennifer D. "A Comparison of Songwriting and Lyric Analysis Techniques to Evoke Emotional Change in a Single Session with People Who Are Chemically Dependent." *Journal of Music Therapy*, vol. 42, no. 2, Summer 2005, pp. 94–110, <https://doi.org/10.1093/jmt/42.2.94>.

- Jurgensmeier, Barbara. *The Effects of Lyric Analysis and Songwriting Music Therapy Techniques on Self-Esteem and Coping Skills Among Homeless Adolescents*. 2012. University of Kansas, <https://kuscholarworks.ku.edu/handle/1808/10764>.
- Juslin, Patrik N. "From Everyday Emotions to Aesthetic Emotions: Towards a Unified Theory of Musical Emotions." *Physics of Life Reviews*, vol. 10, no. 3, Sept. 2013, pp. 235–66, <https://doi.org/10.1016/j.plprev.2013.05.008>.
- . "What Makes Music Emotionally Significant? Exploring the Underlying Mechanisms." *Psychology of Music*, vol. 42, no. 4, July 2014, pp. 599–623, <https://doi.org/10.1177/0305735613484548>.
- Kamioka, Hiroharu, et al. "Effectiveness of Music Therapy: A Summary of Systematic Reviews Based on Randomized Controlled Trials of Music Interventions." *Patient Preference and Adherence*, vol. 8, 2014, p. 727, <https://doi.org/10.2147/PPA.S61340>.
- Koelsch, Stefan. "A Neuroscientific Perspective on Music Therapy." *Annals of the New York Academy of Sciences*, vol. 1169, no. 1, July 2009, pp. 374–84, <https://doi.org/10.1111/j.1749-6632.2009.04592.x>.
- Kornysheva, Katja, et al. "Tuning-in to the Beat: Aesthetic Appreciation of Musical Rhythms Correlates with a Premotor Activity Boost." *Human Brain Mapping*, vol. 31, no. 1, Jan. 2010, pp. 48–64, <https://doi.org/10.1002/hbm.20844>.
- Kupeli, Ilke, and Yakup Gülnahar. "Comparing Different Music Genres in Decreasing Dental Anxiety in Young Adults Who Underwent Third Molar Surgery in Turkey: Randomized Controlled Trial." *Journal of Oral and Maxillofacial Surgery: Official Journal of the American Association of Oral and Maxillofacial Surgeons*, vol. 78, no. 4, Apr. 2020, pp. 546.e1–546.e7, <https://doi.org/10.1016/j.joms.2019.11.029>.
- Labbé, Elise, et al. "Coping with Stress: The Effectiveness of Different Types of Music." *Applied Psychophysiology and Biofeedback*, vol. 32, no. 3-4, Dec. 2007, pp. 163–68, <https://doi.org/10.1007/s10484-007-9043-9>.
- Leal, Pollyana Caldeira, et al. "Trait vs. State Anxiety in Different Threatening Situations." *Trends in Psychiatry and Psychotherapy*, vol. 39, no. 3, Aug. 2017, pp. 147–57, <https://doi.org/10.1590/2237-6089-2016-0044>.
- Leow, Li-Ann, et al. "Individual Differences in Beat Perception Affect Gait Responses to Low- and High-Groove Music." *Frontiers in Human Neuroscience*, vol. 8, Oct. 2014, p. 811, <https://doi.org/10.3389/fnhum.2014.00811>.
- Levitin, Daniel J., et al. "The Psychology of Music: Rhythm and Movement." *Annual Review of Psychology*, vol. 69, Jan. 2018, pp. 51–75, <https://doi.org/10.1146/annurev-psych-122216-011740>.
- Marquez-Garcia, Amparo V., et al. "Music Therapy in Autism Spectrum Disorder: A Systematic Review." *Review Journal of Autism and Developmental Disorders*, vol. 9, no. 1, Mar. 2022, pp. 91–107, <https://doi.org/10.1007/s40489-021-00246-x>.
- Miller, Karen. "A Quick Reference Guide to Lyric Analysis." *American Music Therapy Association*, 2019, <https://amtapro.musictherapy.org/?p=2231>.

- Nilsson, Ulrica. "The Anxiety- and Pain-Reducing Effects of Music Interventions: A Systematic Review." *AORN Journal*, vol. 87, no. 4, Apr. 2008, pp. 780–807, <https://doi.org/10.1016/j.aorn.2007.09.013>.
- O'Kelly, Julian. "Music Therapy in Palliative Care: Current Perspectives." *International Journal of Palliative Nursing*, vol. 8, no. 3, Mar. 2002, pp. 130–36, <https://doi.org/10.12968/ijpn.2002.8.3.10249>.
- Overy, Katie, and Robert Turner. "The Rhythmic Brain." *Cortex; a Journal Devoted to the Study of the Nervous System and Behavior*, vol. 45, no. 1, Jan. 2009, pp. 1–3, <https://doi.org/10.1016/j.cortex.2008.11.002>.
- Silverman, Michael J. "Effects of Lyric Analysis Interventions on Treatment Motivation in Patients on a Detoxification Unit: A Randomized Effectiveness Study." *Journal of Music Therapy*, vol. 52, no. 1, Feb. 2015, pp. 117–34, <https://doi.org/10.1093/jmt/thu057>.
- . "The Use of Lyric Analysis Interventions in Contemporary Psychiatric Music Therapy: Descriptive Results of Songs and Objectives for Clinical Practice." *Music Therapy Perspectives*, vol. 27, no. 1, Jan. 2009, pp. 55–61, <https://doi.org/10.1093/mt/27.1.55>.
- Thaut, Michael H. "Music as Therapy in Early History." *Progress in Brain Research*, vol. 217, Elsevier, 2015, pp. 143–58, <https://doi.org/10.1016/bs.pbr.2014.11.025>.
- . "Neurobiological Foundations of Neurologic Music Therapy: Rhythmic Entrainment and the Motor System." *Frontiers in Psychology*, vol. 5, 2014, p. 1185, <https://doi.org/10.3389/fpsyg.2014.01185>.
- Thompson, W., and F. Russo. "The Attribution of Meaning and Emotion to Song Lyrics." *Polskie Forum Psychologiczne*, vol. 9, no. 1, 2004, pp. 51–62, <https://doi.org/10.32920/ryerson.14639358>.
- Tierney, Adam, and Nina Kraus. "The Ability to Move to a Beat Is Linked to the Consistency of Neural Responses to Sound." *The Journal of Neuroscience: The Official Journal of the Society for Neuroscience*, vol. 33, no. 38, Sept. 2013, pp. 14981–88, <https://doi.org/10.1523/JNEUROSCI.0612-13.2013>.
- Trappe, Hans-Joachim, and Gabriele Voit. "The Cardiovascular Effect of Musical Genres." *Deutsches Arzteblatt International*, vol. 113, no. 20, May 2016, pp. 347–52, <https://doi.org/10.3238/arztebl.2016.0347>.
- "What Is Music Therapy?" *American Music Therapy Organization*, 2005, <https://www.musictherapy.org/about/musictherapy/>.
- Yang, Yi-Hsuan, et al. "Music Emotion Recognition: The Role of Individuality." *Proceedings of the International Workshop on Human-Centered Multimedia*, Association for Computing Machinery, 2007, pp. 13–22, <https://doi.org/10.1145/1290128.1290132>.
- Yi, Cao, et al. "Cognitive Behavior, Art, and Music Therapies Intervention for Treating the Depression of Children: A Randomized Control Trial." *Psychiatry Research*, vol. 333, Mar. 2024, p. 115716, <https://doi.org/10.1016/j.psychres.2024.115716>.

## Quantum Mechanics and the Wave Function by Dhairya Jaswani

### Abstract

This paper attempts to explain some fundamental concepts and properties of wave functions in quantum mechanics, such as what they represent and real-world examples of them. In terms of mathematical background, this paper assumes that readers have some understanding of complex numbers, calculus, and probability before reading. The paper gives a brief overview of the development of quantum mechanics, then focuses on wave functions in quantum mechanics, and situations in which they are used. It covers eigenfunctions, eigenvalues, and operators in quantum mechanics, then introduces the Schrodinger Equation and an application of it in the infinite square well. The paper also briefly discusses some real-world applications and uses of wave functions as well as quantum mechanics in general, such as quantum computing and transistors.

### Introduction

In the words of Richard P. Feynman, "If you think you understand quantum mechanics, you do not understand quantum mechanics." Quantum mechanics is in no way a simple topic, but it certainly is interesting. In quantum mechanics, things are probabilistic. This is much different from what is usually seen on the scale of larger objects in which everything is deterministic and can be modeled and predicted almost exactly. The probabilistic nature of systems on extremely small scales, the scale described by quantum mechanics, can be modeled by something known as a wave function. Wave functions are an essential part of quantum mechanics and are the basis for what sets quantum mechanics apart from classical mechanics.

Quantum mechanics is a relatively new field, as it appeared in the early 1900s, compared to the well-known classical mechanics being hundreds of years old. One of the reasons it has taken longer for quantum mechanics to surface and develop, along with more obvious factors like other discoveries and technological advancements leading up to it, is that people were very hesitant to accept it. The new and strange behaviors exhibited by quantum mechanical objects were just too much of a change from the classical mechanics that people knew and could observe. An example of this was shown by Albert Einstein, who famously said, "God does not play dice," when referring to the uncertainty described by quantum mechanics. This new notion that quantum mechanics provided, one that stated that things acted on probability, was one that many scientists of the time simply could not accept. However, as time passed and more experiments and research occurred, this strange behavior of objects on the smallest scales became no longer a theory, but a reality.

Quantum mechanics is something that may seem daunting to many who are just starting to explore it. Many people may see strange symbols being used and think quantum mechanics must be far too complicated, while others simply decide for themselves that it is impossible to understand. And while it is true that getting a deep understanding of quantum mechanics is something only a handful of people have managed to achieve, parts of it are much simpler than



they may initially appear. Some of the most important aspects of quantum mechanics can be understood, at least to a certain extent, with just the knowledge of complex numbers and calculus. It is this level of understanding of quantum mechanics, specifically with wave functions, that this paper aims to instill.

### **A Brief History of Quantum Mechanics**

Quantum mechanics was first born with Max Planck, who introduced the idea that light is emitted in chunks of energy that are quantized and discrete, rather than being continuous. He stated that these chunks come in energies equal to integer multiples of a constant multiplied by the frequency of light. This constant was  $h$ , now known as Planck's constant. It is often helpful to use the reduced Planck's constant  $\hbar$ , which is equal to  $\frac{h}{2\pi}$ . This created two equivalent equations for these energy chunks,  $E = h\nu$  and  $E = \hbar\omega$ , where  $\nu$  is the frequency, and  $\omega$  is angular frequency.<sup>[1]</sup> Because of how small these energy chunks are, however, the energy usually appears continuous. This helped to solve a problem at the time known as the "*blackbody radiation*" problem, in which the view of light energy being continuous seemed to allow for some objects to emit an infinite amount of radiative energy. This was nicknamed the "Ultraviolet Catastrophe," and was predicted by the Rayleigh-Jeans Law, the primary model at the time for describing the intensity of radiation in relation to the temperature and frequency. The Rayleigh-Jeans Law predicted that as the wavelength approached the ultraviolet end of the spectrum, the radiation intensity would explode to infinity.<sup>[2]</sup> Planck's discovery of these energy chunks solved that problem and created a much better model for the radiation.

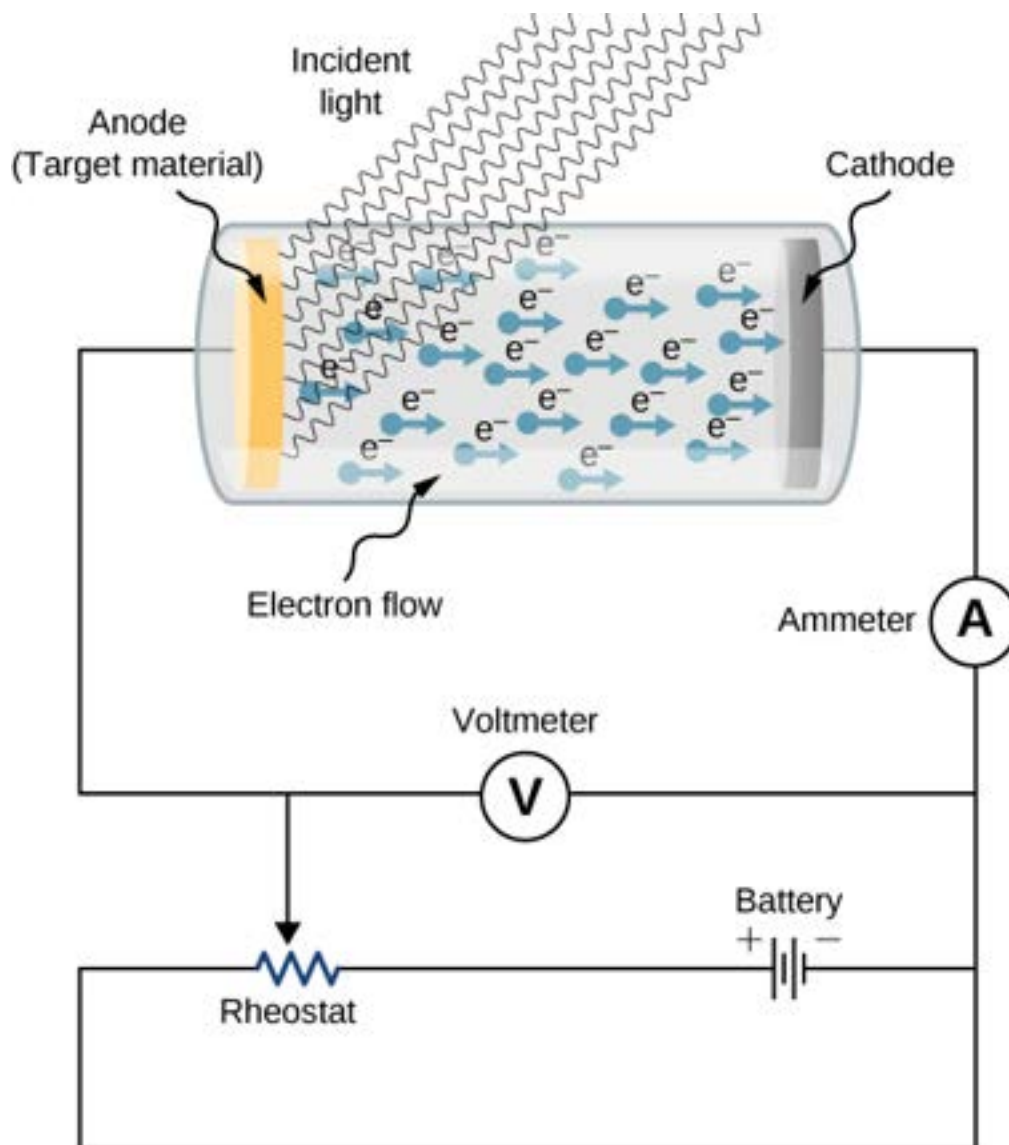

Figure 1: A representation of the setup used in experiments on the photoelectric effect. Light is targeted at the target material where electrons are stuck, and high enough frequency light will cause electrons to be ejected and move to the cathode, creating a current. Credit: Citation [4].

A few years later, in 1905, Einstein interpreted these chunks of light energy as particles, now called photons. This was as a result of the experiments conducted on the photoelectric effect.<sup>[1]</sup> The photoelectric effect was seen in an experiment which showed that light waves with shorter wavelengths, and thus higher energy, were able to knock electrons off of a material. In the most prominent version of the experiment (see Figure 1), a voltage difference is created between two plates by connecting them to a battery. Electrons are stuck to one of the plates, the “emitter plate.” When no light or low energy light is shone on the emitter plate, no electrons are knocked off and passed between the plates, so there is no current. However, higher energy

(which is directly proportional to frequency) light is able to force some electrons off the emitter plate and onto the other one, allowing a current to flow.<sup>[3]</sup>

Experiments conducted with the photoelectric effect revealed results that contradicted predictions made based on the assumption that light was a wave. For example, a model that treated light as a wave would predict that increasing the intensity and amplitude of the light would increase the kinetic energy of the electrons emitted, while a higher frequency would lead to a higher electron emission rate with constant energy, also leading to a higher observed current. However, the results for the experiment actually showed the opposite. A higher intensity and amplitude of the light led to an increase in electron emissions but no change in energy, while higher frequency light resulted in higher kinetic energy of the electrons but the same rate of emission. Einstein realized that these results were consistent with what would be predicted if light was instead a beam of particles, and these particles are now known as photons. This also revealed that the total energy of the photon is equal to the kinetic energy of the electron emitted (each electron absorbs the energy of just one photon) plus the work function, which is the threshold energy needed to emit an electron at all, and varies depending on the metal. This is modeled in the equation

$$E_{\text{photon}} = KE_{\text{electron}} + \phi \quad (1)$$

where  $\phi$  is the work function. The energy of the photon was also shown to be described by Planck's equation  $E = h\nu$ , but while Planck had earlier believed it was simply a property of the problem he was working with, Einstein realized that this property of quantized energy chunks was inherent to light itself.

Neils Bohr conducted important work in establishing a model for the atom that incorporated quantum mechanical properties. He created a model that satisfied and correctly explained properties that had been observed, such as the quantization of energy. However, his model also included features that were much different than what classical mechanics would predict. For one, the Bohr model said that the electron could jump between energy states, for example from the ground state to excited states.<sup>[5]</sup> This could be done by the absorption of a photon for a jump to a higher energy state, and the emission of a photon for a jump to a lower state (see Figure 2). The energy of these photons were equivalent to the difference in energy of the two energy states, and given  $E = h\nu$  for photons, the frequency of the photon could then be calculated. The photon emissions from such energy jumps lead to atomic spectra, one of the best known being the Balmer Series of visible light emissions, which results from electrons jumping to the  $n = 2$  energy state from higher states of a hydrogen atom. While it was true that his model only worked for hydrogen or hydrogen-like atoms with one electron, it still provided important ideas and insights for a complete and conclusive model. Features of his model also led to the observation that electrons displayed both wave-like and particle-like properties in differing scenarios, and this idea would be built upon in future experiments.<sup>[1]</sup>

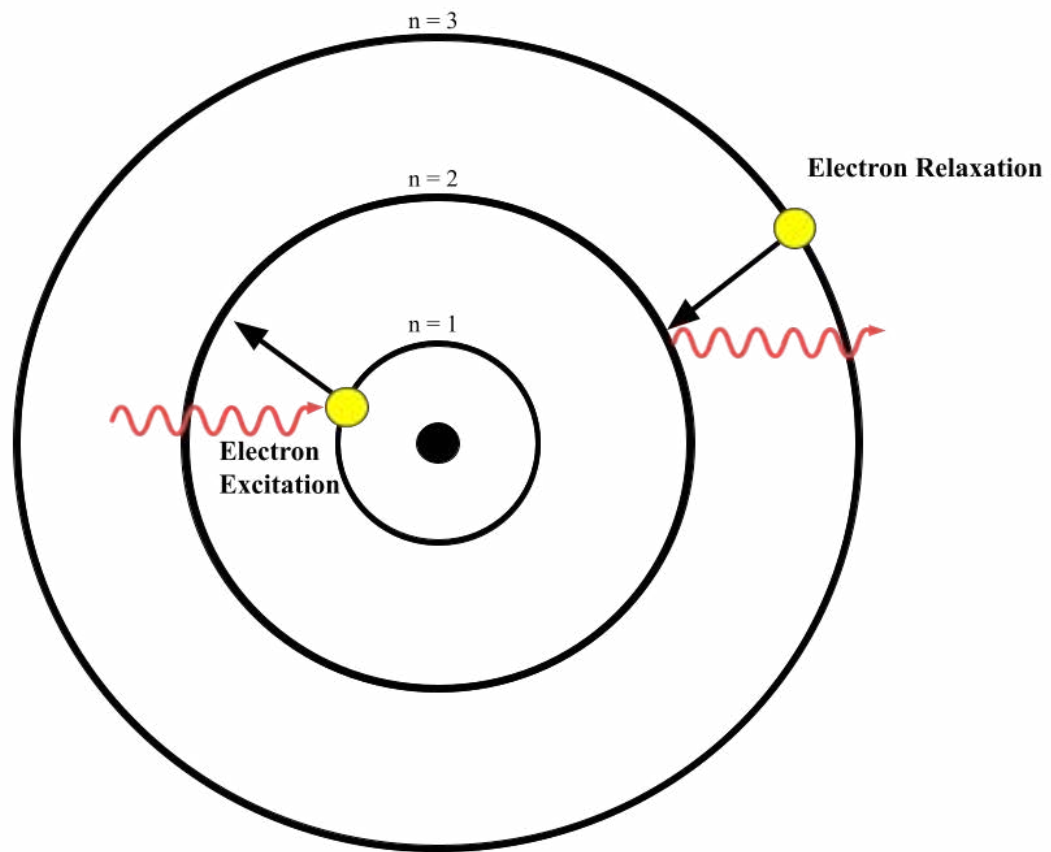

Figure 2: A representation of Bohr’s model for the hydrogen atom, with electrons orbiting around a small nucleus, and electrons switching energy states by absorbing or emitting photons.

In 1924, Louis de Broglie proposed the idea that not only electrons but all particles have waves associated with them.<sup>[1]</sup> He suggested that both their angular frequency  $\omega$  and wavenumber  $k$  were related to their energy and momentum by  $E = \hbar\omega$  and  $p = \hbar k$ , respectively, where  $k$  is  $\frac{2\pi}{\lambda}$ , and  $\lambda$  is wavelength. This meant that larger systems with a high energy and momentum compared to individual particles had much larger frequencies and wavenumbers, which is why matter on large scales does not display observable wavelike properties. This fact that all particles had associated waves led to wave-particle duality, which is still not entirely understood. However, the very basic and general idea is that particles behave as waves until they are measured, at which point they behave like particles.

It was just two years after this, in 1926, that Erwin Schrodinger published his work on a differential wave equation<sup>[1]</sup> that governed how these waves, or “wave functions,” usually represented by  $\psi$  evolved and moved through space and time. This equation is known as the Schrodinger Equation and is one of the most important equations in quantum mechanics, which will be discussed in more detail later. While the idea of a wave function had been developed for quite some time prior to this equation, namely through the De Broglie relationships, this was the first time that the wave function was explicitly constructed and described. Despite the fact that

his equation correctly modeled wave functions, however, he did not know at the time what they represented.

These wave functions were later correctly interpreted by Max Born as probability amplitudes. This introduced Born's rule, which states that the actual probability, or probability density of finding a particle at some location  $x$  is given by

$$P(x) = |\psi(x)|^2 dx,^{[1]} \quad (2)$$

and the probability over some interval is integral over that interval. Born's rule also introduced the basis of the probabilistic nature of quantum mechanics, setting it off from deterministic classical mechanics. This probabilism is not some result of lack of information about a particle or system; these measurements of position and other properties are fundamentally random and unpredictable. This same principle can be applied to other properties of the particle too, as will be soon shown.

One of the most popular experiments conducted in quantum mechanics is the double-slit experiment (see Figure 3). In this experiment, a beam of photons (electrons are also sometimes used) is shot, one at a time, towards a plate with two slits in it.<sup>[6]</sup> Behind the plate, there is a screen that detects where an electron makes contact. Following classical mechanics, one might expect to see two distinct lines on the screen form, one from electrons passing through each slit, or a random distribution of them. And while the dots on the screen may seem randomly distributed at first, as time passes and more particles are shot, multiple distinct strips are observed. This is an interference pattern from the constructive and destructive interference of the particles behaving as waves entering the two slits, with particles denser in the middle and less towards the sides. Covering one of the slits removed this pattern, as did placing a device near the slits to observe which slit the particle passed through. This proved both the wave nature of electrons and other particles, and that the wave function represented the probability amplitude function. It was also a great example of the fact that particles/waves behave differently upon measurement, as placing an observer device at the slits to record which slit the particle passes through results in the classically expected two slits. The research and experiments, such as this one, conducted on the behavior of particles by researchers has led to quantum mechanics as it is known today.

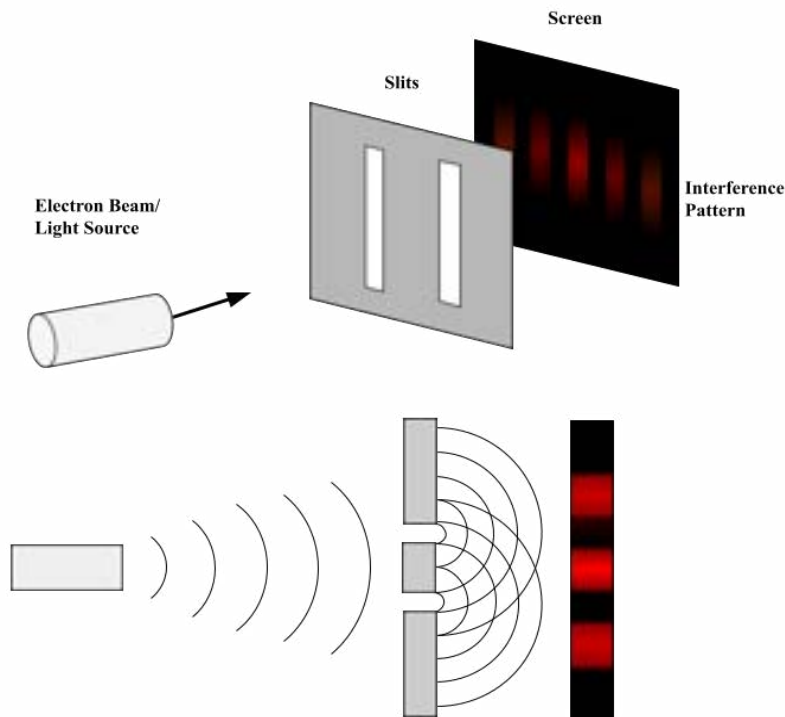

Figure 3: A simplistic representation of the double slit experiment, in which a beam of electrons or photons is shot towards a plate with two slits and recorded by a screen on the other side. The positions on the screen initially seem random, but an interference pattern caused by the particles' wave-like nature begins to form as time passes.

## Wave Functions

### Basics of Wave Functions

Wave functions are the basis of much of quantum mechanics. A wave function is a complex function, meaning it is made of up real and imaginary components, that describes a quantum system. Mathematically speaking, it represents the probability amplitude function as found by Max Born. This results in the actual probability being represented by Equation (2) as shown earlier.

The wave function of a quantum system can be used to determine *every* property of the system that can be experimentally measured, such as position, momentum, and energy, up to a level of certainty. However, as a result of properties of wave functions, there is a non-trivial amount of uncertainty in properties of the system prior to a measurement being made. Almost every strange quantum mechanical phenomenon that can be observed is a direct result of the fact that particles and systems are associated with wave functions that encode this uncertainty. This also results in one of the most important strange phenomena, being that the behavior of a system

is probabilistic on atomic and subatomic scales. This is in contrast with the deterministic behavior observed on larger scales modeled by classical mechanics.

Before discussing the workings of these wave functions, what do they actually look like? Since they are complex functions, they are difficult to visualize, as it would require use of the complex plane as well. It turns out that graphing the complex components of wave functions in isolation is not entirely necessary. Because of this, it is often the square of the complex height, or amplitude, of the wave function that is graphed.

Now, the real part of the graph can take on nearly any shape and size. However, there are some restrictions on what wave functions are acceptable. For one, wave functions must be single valued, meaning each (x,t) input should have exactly one value on the wave function. Wave functions must also be “smooth,” meaning that they can be graphed without any sharp points or bends; in other words, they must be differentiable. Additionally, wave functions must be continuous, for which they must satisfy three properties: for every x, the function  $\psi(x)$  must exist, the limit  $\lim_{a \rightarrow x} \psi(a)$  must exist, and  $\psi(x) = \lim_{a \rightarrow x} \psi(a)$ . While there are some technicalities with these conditions, they are very rare, so they will not be discussed. There is also the condition of normalization which is discussed later.

### Operators, Eigenfunctions, and Eigenvalues

The next step is to understand what operators are. In basic terms, operators are mathematical entities that act on something, in this case on wave functions, in a specific way. Nearly anything can be an operator, an example being the operator 1, which simply returns the same function back. Or, it could be  $\frac{d}{dx}$ , the derivative operator, which takes the derivative of the function it acts on. However, there are different types of operators, and in quantum mechanics Hermitian operators are the most important as they are the operators used to define physical observables. Observables are properties of a system which can be determined experimentally such as position or momentum. An operator  $\hat{A}$  is defined as Hermitian if it satisfies the condition

$$\hat{A} = \hat{A}^\dagger \quad (3)$$

The operator  $\hat{A}^\dagger$  is known as the adjoint or Hermitian adjoint of  $\hat{A}$  and is defined as the operator corresponding to  $\hat{A}$  such that

$$\int (\hat{A}\psi_1(x))\psi_2(x) dx \equiv \int \psi_1^*(x)(\hat{A}^\dagger \psi_2(x)) dx \quad (4)$$

for any functions  $\psi_1(x)$  and  $\psi_2(x)$ , and where  $\psi_1^*(x)$  is the complex conjugate of  $\psi_1(x)$ . The complex conjugate is defined as inverting the sign of all imaginary units  $i$ , such as changing  $e^{ix}$  to  $e^{-ix}$ . Hermitian operators are also known as self-adjoint operators.

Usually, the action of an operator on a wave function will result in a different wave function. However, associated with every operator there exists a set of wave functions for which

the action of the operator upon it results in the same wave function again, multiplied by a scalar. This can be represented by the equation

$$\hat{A}\psi_a(x) = a\psi_a(x) \quad (5)$$

where  $a$  is a complex number. Here,  $\psi_a$  is the eigenfunction, or the eigenstate, of  $\hat{A}$  corresponding to the eigenvalue  $a$ . Upon measurement of an observable represented by a certain operator, the measured value will be one of the eigenvalues of the operator. Additionally, the wave function acted on by the operator will collapse into one of the eigenfunctions through probability. This can be shown through the example of electron spin, where an electron can possess either spin  $\frac{1}{2}$  or  $-\frac{1}{2}$ . Upon measurement of the spin of an electron, its corresponding wave function collapses into an eigenfunction of the spin operator.

Hermitian operators have some interesting properties regarding their eigenfunctions and eigenvalues. For one, Hermitian operators will always have strictly real eigenvalues.<sup>[7]</sup> However, the eigenfunctions may be complex. Additionally, eigenfunctions of a Hermitian operator can always be chosen such that they are normalized and mutually orthogonal. A wave function is normalized if the probability for finding the particle it represents at any location sums to be 1. For two wave functions to be orthogonal, they must satisfy the condition

$$\int_{-\infty}^{\infty} \psi_1^*(x)\psi_2(x) dx = 0 \quad (6)$$

The eigenfunctions of a Hermitian operator form a “complete” set such that *any* wave function can be represented as a linear combination of them, and this set is also known as a basis.<sup>3</sup> In this sense, a linear combination is the sum of these eigenfunctions with each term multiplied by a scalar, sometimes referred to as an expansion coefficient. This can be used to represent any wave function  $\Psi(x)$  as a linear combination of eigenfunctions  $\psi_n$  corresponding to some arbitrary operator through the equation

$$\Psi(x) = \sum_{n=1} c_n \psi_n \quad (7)$$

where all  $c_n$  are the expansion coefficients and are complex numbers. These expansion coefficients can be used to determine the probability of the wave function collapsing into a certain eigenfunction as discussed earlier. The probability of collapse into an eigenfunction  $\psi_n$  is equal to  $|c_n|^2$ , assuming the wave function and eigenfunctions are normalized. In a similar way, the probability for finding a particle in some region is given by

$$P(x) = \int_a^b |\Psi(x)|^2 dx \quad (8)$$

as given from Born’s rule.<sup>[8]</sup> To ensure the wave function is normalized as mentioned earlier, the wave function must satisfy



$$\int_{-\infty}^{\infty} |\Psi(x)|^2 dx = 1 \quad (9)$$

or in other words, the particle must be found somewhere. If it is not equal to one, that would mean that there is either a higher than 1 probability of finding the particle over infinite space, or a less than 1 probability, neither of which is possible.

### Position, Momentum, and the Heisenberg Uncertainty Principle

A commonly used operator is the momentum operator,

$$\hat{p} = -i\hbar \frac{\partial}{\partial x} \quad (10)$$

and it can be used as an example for the eigenfunction property. Here, the eigenfunctions turn out to be wave functions in the form

$$\psi = e^{ikx} \quad (11)$$

where  $k$  is the wave number defined as  $k = \frac{2\pi}{\lambda}$  with wavelength  $\lambda$ . Plugging in for  $\psi$  in

$\hat{p}\psi = p\psi$  with eigenvalues  $p$ , it is found that

$$\hat{p}\psi = -i\hbar \frac{\partial}{\partial x} e^{ikx} = \hbar k e^{ikx} \quad (12)$$

Thus, it is found that for eigenfunctions  $e^{ikx}$  associated with the momentum operator, the eigenvalues are  $\hbar k$ . Thus, systems described by a wave function of the form  $e^{ikx}$  have momentum  $p = \hbar k$ .

For the position operator, another common operator denoted by either  $\hat{X}$  or  $\hat{x}$ , the eigenfunctions are Dirac deltas in the form  $\delta(x - x_0)$  with the operator being simply defined as

$$\hat{X} = x \quad (13)$$

Dirac deltas are defined such that the delta  $\delta(x - x_0)$  is equal to zero everywhere except for when  $x = x_0$ , where the argument becomes zero and the delta peaks to infinity. Here,  $x_0$  is the position the function should peak at. Having these deltas as position eigenfunctions makes sense, because these delta functions represent certainty in the position of a particle. The corresponding eigenvalue is thus simply  $x_0$ . It is important to note that Dirac deltas are not functions in the mathematical sense and do violate properties that wave functions must have. Because of this, they are not actually physical and do not exist as wave functions in the real world, but they are used as a theoretical and technical example.

In general, operators do not commute, which is also the case for the position and momentum operators. This means that the order in which operators are applied to a wave function matters, and flipping the order could change the result. There are some cases where operators do commute, and their order of application does not matter, but such cases are not frequent. The commutativity of two operators can be checked using the commutator, denoted

$[\hat{A}, \hat{B}]$ . For the position and momentum operators, it would then be  $[\hat{x}, \hat{p}]$ . The commutator of these two operators, which can be replaced by any general operators, would be defined as

$$[\hat{x}, \hat{p}]\psi(x) = \hat{x}\hat{p}\psi(x) - \hat{p}\hat{x}\psi(x). \quad (14)$$

Simply speaking, it defines how much of a difference the order of two operators makes. In this case,  $[\hat{x}, \hat{p}] = i\hbar$ . This means that the position and momentum operators do not commute, and their order does matter. Switching the order of the operators inside the commutator does not make a significant difference, as it would simply change the value from positive to negative or vice versa.

The commutator leads directly to a property that a group of operators and observables can share, which is compatibility. It is essentially the same as commutativity, but in this case it also provides information about the uncertainty in measuring observables simultaneously. Observables and their corresponding operators are compatible if they can be measured and known with certainty at the same time. This is something that occurs when the commutator of the operators is equal to zero, since it means that the order in which the two observables are measured does not change the result, and thus there is no uncertainty in knowing the two observables at the same time. However, if the commutator has a nonzero value for two operators, such as the position and momentum operators, the associated observables cannot both be known simultaneously with certainty at the same time and are incompatible.

This uncertainty can be strictly represented by something known as the Heisenberg Uncertainty Principle, or simply the uncertainty principle, discovered by theoretical physicist Werner Heisenberg.<sup>[10]</sup> It is most commonly known and used for position and momentum, and it states that

$$\sigma_x \sigma_p \geq \frac{\hbar}{2} \quad (15)$$

The symbol  $\sigma$ , or sigma, represents the uncertainty in the measurement of an operator. This relation means that the product of the uncertainty in the measurements of both position and momentum of a particle at the same time will always be greater than or equal to  $\frac{\hbar}{2}$ . Thus, if the certainty in one measurement increases, there will be an increasing uncertainty in the other, and they cannot be known with a high level of certainty simultaneously. It is very important to note, however, that this relation is only true on quantum scales, not for most objects one would see everyday. For these macroscopic objects, such observables can be measured and known at the same time with a level of certainty, one that often exceeds the precision of the measuring tools being used. While the uncertainty principle is usually shown for position and momentum, different uncertainty relations exist for other operators.

### **The Hamiltonian and the Schrodinger Equation**

While the position and momentum operators are common operators that are fundamental to describing and measuring particles and other quantum systems, an arguably more important

operator is one known as the Hamiltonian. The Hamiltonian of a system is the operator representing its total energy. This gives the eigenfunction equation

$$\hat{H}\psi(x, t) = E\psi(x, t) \quad (16)$$

The Hamiltonian itself can be decomposed into the sum of two terms representing the kinetic and potential energy. The kinetic energy term can initially be modeled by the equation

$$KE = \frac{1}{2}mv^2 \quad (17)$$

where  $KE$  is the kinetic energy,  $m$  is the mass and  $v$  is the velocity. After substituting in for the fact that  $p = mv$ , with momentum  $p$ , it can be written that

$$KE = \frac{p^2}{2m} \quad (18)$$

The potential energy is a function that will vary depending on the system, so it can simply be represented by some function  $V(x)$ . That results in the expression

$$\frac{p^2}{2m} + V(x) \quad (19)$$

However, the Hamiltonian operator replaces  $p$  and  $x$  with the momentum and position operators, respectively. Substituting both of those in from Equation (9) for momentum and Equation (12) for position,

$$\hat{H} = -\frac{\hbar^2}{2m} \frac{d^2}{dx^2} + V(x) \quad (20)$$

Finally, applying the wave function to both sides and using the eigenfunction equation for the Hamiltonian, it is found that

$$E\psi(x) = -\frac{\hbar^2}{2m} \frac{d^2}{dx^2} \psi(x) + V(x)\psi(x) \quad (21)$$

This equation is actually quite important. In fact, this equation is the time-independent Schrodinger Equation. The Schrodinger Equation is possibly the most important equation in quantum mechanics, governing the motion and evolution of wave functions, and used to solve for wave functions in specific situations. Along with the time-independent Schrodinger Equation there is a time-dependent Schrodinger Equation, which includes time dependence and time derivatives in the equation, and is written as

$$i\hbar \frac{\partial}{\partial t} \psi(x, t) = -\frac{\hbar^2}{2m} \frac{d^2}{dx^2} \psi(x, t) + V(x)\psi(x, t)^{[11]} \quad (22)$$

The time-dependent equation is more frequently used in real-world applications, as it accounts for evolution through time as well as space. As the Schrodinger Equation is a second-order partial differential equation, it is also linear. That means that any arbitrary linear combination of the solutions to the equation is itself also a solution.

Both the time-dependent and time-independent Schrodinger Equations shown above only describe wave functions in one spatial dimension. The equation can be expanded, however, to describe wave functions in two and three spatial dimensions, and for theoretical purposes, higher dimensions too. While it does end up making the equations larger and more messy in general, it is important to know that it is possible to expand the equations to higher dimensions.

A common method used to solve the time-dependent Schrodinger Equation is known as separation of variables. As the name might suggest, this method involves splitting the wave function into the product of two functions, each one only dependent on one variable. This can be shown as

$$\Psi(x, t) = \psi(x)\phi(t) \quad (23)$$

The separated wave function is substituted into the Schrodinger Equation, which is then rearranged such that one side of the equation is entirely time-dependent, while the other side is only space-dependent. This not only makes this a standard differential equation instead of a partial differential equation, it also makes it more convenient to solve for the wave function overall. This method can be used to solve for the complete wave function in many different situations, both theoretical and practical.

### Solving the Schrodinger Equation in the Infinite Square Well

One such famous system that the Schrodinger Equation can be applied to is known as the infinite square well. It is a theoretical example commonly used to demonstrate how the Schrodinger Equation can be used to solve for wave functions given some initial conditions and requirements. In this example, a particle is trapped in a 1-D box of length  $L$  and infinitely high potential walls. The walls and the area outside the box have infinite potential energy, while there is zero potential inside the box.<sup>[12]</sup> These conditions have two important implications. First, the potential energy term in the equation can be disregarded for regions inside the box, and second, there should be a zero probability of finding the particle anywhere outside the box, meaning the wave function is equal to zero everywhere outside the box. In order to keep the wave function continuous, the value of the wave function at both walls should also be equal to zero. These set the boundary conditions for the problem.

It is known from the initial conditions that the potential energy inside the box is equal to zero and the potential energy term in the Schrodinger Equation can be disregarded, so the Schrodinger Equation in this situation can now be written as

$$-\frac{\hbar^2}{2m} \frac{d^2}{dx^2} \psi(x) = E\psi(x) \quad (24)$$

This has solutions in the form

$$\psi(x) = Ae^{ikx} + Be^{-ikx} \quad (25)$$

Now, since the wave function must be equal to 0 at both  $x = 0$  and  $x = L$ , 0 can be plugged in for  $x$  and it is found that  $B = -A$ . This results in

$$\psi(x) = Ae^{ikx} - Ae^{-ikx} \quad (26)$$

Euler's formula can be applied here, which states

$$e^{i\theta} = \cos(\theta) + i\sin(\theta) \quad (27)$$

After substituting  $kx$  and  $-kx$  as  $\theta$  for the first and second terms, respectively, and applying Euler's formula, Equation (25) can be simplified to

$$\psi(x) = A\sin(kx) \quad (28)$$

Note that here,  $A$  is the normalization constant, or the constant by which the wave function must be multiplied to remain normalized, and will be solved for soon. From the condition that at  $L$ , the position of the second wall of the box, the wave function must equal zero, it is found that

$$\psi(L) = A \sin(kL) = 0 \quad (29)$$

For this to be true,  $\sin(kL)$  must be equal to zero. A property of the  $\sin$  function is that it is equal to zero when it has an argument  $n\pi$  for any integer  $n$ . This means

$$kL = n\pi \quad (30)$$

and  $k$  is found as

$$k = \frac{n\pi}{L} \quad (31)$$

Thus, the wave function can be written as

$$\psi_n(x) = A \sin\left(\frac{n\pi}{L}x\right) \quad (32)$$

for positive integers  $n$ , and each integer  $n$  results in a different eigenfunction.

The final step in finding the eigenfunctions is to solve for  $A$ , the normalization constant. It can first be plugged into the normalization requirement. This results in the equation

$$\int_{-\infty}^{\infty} |\psi_n(x)|^2 dx = \int_0^L |A|^2 \sin^2\left(\frac{n\pi}{L}x\right) dx = 1 \quad (33)$$

The bounds of the integral are changed to 0 and  $L$  as the wave function is zero anywhere outside of that range, as given by the initial conditions. The integral itself can be solved and simplified to find that

$$|A|^2 \frac{L}{2} = 1 \quad (34)$$

meaning

$$|A| = \sqrt{\frac{2}{L}} \quad (35)$$

This leads to the result that the infinite square well has eigenfunctions in the form

$$\psi_n(x) = \sqrt{\frac{2}{L}} \sin\left(\frac{n\pi}{L}x\right) \quad (36)$$

Plugging this into Equation (23) it is found that corresponding to the Hamiltonian, these eigenfunctions have energy eigenvalues in the form

$$E_n = \frac{n^2 \pi^2 \hbar^2}{2mL^2} \quad (37)$$

with mass of the particle  $m$ . Recall that for both the eigenfunctions and eigenvalues,  $L$  is the length of the infinite square well, and  $n$  is a positive integer starting from 1. When  $n = 1$ , notice that the energy is not equal to zero. This is because the energy of a particle will never be exactly equal to zero, and instead will have some minimum energy at the  $n = 1$  eigenvalue. The state corresponding to this lowest energy value at  $n = 1$  is known as the ground state while the states corresponding to higher  $n$ 's are known as excited states and have higher energy values. In fact, the energy levels increase in the form of a quadratic as  $n$  increases, since as  $n$  increases the

energy values are scaled by a factor of  $n^2$ . Plugging in the values for  $n$ ,  $m$ , and  $L$  results in the actual energy value corresponding to the chosen  $n$ .

Another important thing to notice is that the eigenfunctions here are time-independent. This means that they can be substituted for  $\psi(x)$  in the separation of variables from earlier, in Equation (22). The time-dependent part  $\phi(t)$  can be solved to be  $e^{-i\frac{E_n t}{\hbar}}$ , so it is found that the complete, time-dependent wave functions

$$\Psi_n(x, t) = \sqrt{\frac{2}{L}} \sin\left(\frac{n\pi}{L}x\right) e^{-i\frac{E_n t}{\hbar}} \quad (38)$$

are solutions to the time-dependent Schrodinger equation as well as the 1-D infinite square well. As a result of the linearity of the Schrodinger Equation, any arbitrary linear combination of these wave functions would be a solution to both as well.

Wave functions in the above form are also known as stationary states of the infinite square well, or stationary states in general. A stationary state is defined as any state and corresponding wave function such that even if the wave function itself is time-dependent, all observables of the state are time-independent and do not depend on time. This essentially means that the stationary state does not evolve with time, and is thus “stationary.” Energy eigenfunctions all fit this definition, meaning that they are all stationary states. An important thing to note, however, is that there are no real-world stationary states. The concept of a stationary state is used more theoretically and not in the real world, as there is no state that will remain entirely stationary and time-independent.

Going back to the time-independent eigenfunctions of the infinite square well, graphing their real-parts as well as  $|\psi_n(x)|^2$  leads to some interesting findings. Given that  $n$  starts from 1, then for each  $n$ th eigenfunction there are  $n - 1$  “nodes”, or points where the value of the wave function equals 0, not including at the walls. This results in an effect due to the probability equation, Equation (7), that the probability of finding the particle at the nodes and at the edges of the box where  $\psi(x) = 0$  is vanishing, and very unlikely in the areas around the nodes. Instead, it is likely to be found between these nodes. This is much different from what would be expected in classical mechanics, where the probability distribution would be constant and equally likely everywhere. This effect starts to change when looking at very high-energy eigenfunctions, or eigenfunctions corresponding to a high  $n$ . With these eigenfunctions the probability starts to behave more constant, at least in terms of measurement. This is because if the scale that the measurements are able to be performed on is less than  $\frac{L}{n}$ , which becomes a much smaller size as  $n$  increases, then the probability distribution will appear constant during measurements.

The infinite square well is just one example of how the Schrodinger Equation can be applied and solved. While this was a simple theoretical situation for its application, the Schrodinger Equation can also be applied in more complex ways, such as using the 3-D Schrodinger Equation to solve for electron wave functions in a hydrogen atom. In fact, a modified version of the infinite square well, a series of connected finite square wells with a

voltage across them, describes real-world devices such as quantum-cascade lasers, which have a wide range of applications. While using the Schrodinger Equation in these types of complex situations is harder and more messy, it is certainly possible.

## Conclusion

In summary, the complete configuration of a quantum system, such as a particle or an atom, can be described by a wave function  $\psi(x)$ . Wave functions are complex functions that represent the probability amplitude of finding the system at a certain location. The motion and evolution of these wave functions is governed by the Schrodinger Equation, a partial differential wave equation that is split into the time dependent and time independent equations. This equation can be applied to solve many quantum mechanical problems involving the wave function, and can be modified and expanded to solve for systems with different dimensions or sizes.

Due to properties of the wave function, quantum systems can lie in a “superposition” of multiple states. For example, an electron can be in a state of spin  $\frac{1}{2}$  or  $-\frac{1}{2}$ , but it can also exist in a superposition of both of them until it is observed, at which point the wave function collapses into one of the states based on probability.

Physical quantities, or observables, of a system can be represented by operators. Operators are entities that act on wave functions in a specific way, and in most cases will return a wave function different from the original. However, corresponding to each operator there is a set of special functions called eigenfunctions, such that the action of the operator on the eigenfunction returns the eigenfunction again multiplied by a value, the corresponding eigenvalue. These eigenfunctions and eigenvalues are essential to quantum mechanics, as any wave function can be written as an arbitrary linear combination, or superposition, of them. Upon measurement of the corresponding operator, the wave function will collapse into one of the eigenfunctions it is made up of, and the measurement will have the corresponding eigenvalue as the result.

The implications of wave functions and quantum mechanics are important because quantum mechanics has been, and still is, used to develop things used daily, as well as experimental yet powerful technology. For example, the study of discrete energy states of electrons led to the discovery of semiconductors, materials whose conductivity lies between that of conductors and insulators. These semiconductors are one of the key components in technology, such as in developing transistors, used in almost every electronic device.

A newer technology that quantum mechanics has led to is quantum computing, a developing technology being researched by many groups across the world. Quantum computers are still mainly prototypes, but they are already able to solve certain types of problems much faster than classical computers or even supercomputers could. This is because of their use of qubits, which can represent a superposition of both 0s and 1s simultaneously, as opposed to classical computers using bits that are exactly either a 0 or a 1. This leads to an exponential increase in computational power as qubits increase. The drawbacks to this technology are that

though it is very well suited for certain problems like optimization, it is inconvenient and impractical for most everyday usage. Also, they are expensive and require specific, precise conditions in order to run, and even after that they are often inaccurate and have errors. Still, it is a promising technology that could lead to many more things in the future than it is capable of today.

While these technologies seem to show that scientists and researchers have a pretty good understanding of the strange phenomena of quantum mechanics, there is still much work to be done on it for further understanding. For one, there are still gaps in quantum mechanics that must be filled, such as how gravity works on quantum scales and why the wave function collapses when it is observed. Future work could also be done on beginning to harness quantum mechanical effects to our advantage through new research, similarly to how superposition is used in quantum computing. More work must also be done on better understanding certain phenomena, such as the implications of the wave-particle duality of matter and quantum entanglement. Nevertheless, understanding quantum mechanics at the level researchers do now has led to many discoveries, and understanding it further will likely lead to many more.



## Works Cited

- [1] Morin, David. "Introduction to Quantum Mechanics." *Scholars at Harvard*, Harvard, scholar.harvard.edu/files/david-morin/files/waves\_quantum.pdf. Accessed 2024.
- [2] Nave, Rod. "Blackbody Radiation." *HyperPhysics*, hyperphysics.phy-astr.gsu.edu/hbase/mod6.html#c4. Accessed 2024.
- [3] *The Photoelectric Effect*, web.fscj.edu/Milczanowski/psc/lect/Ch8/slide5.htm. Accessed 2024.
- [4] Ling, Samuel J., et al. "Photoelectric Effect." *University Physics Volume 3*, University of Central Florida, pressbooks.online.ucf.edu/osuniversityphysics3/chapter/photoelectric-effect/#CNX\_UPhysics\_39\_02\_photoexp2. Accessed 2024.
- [5] Faye, Jan. "Copenhagen Interpretation of Quantum Mechanics." *Stanford Encyclopedia of Philosophy*, Stanford University, 6 Dec. 2019, plato.stanford.edu/entries/qm-copenhagen/#toc. Accessed 2024.
- [6] Tavabi, Amir H., et al. "The Young-Feynman Controlled Double-Slit Electron Interference Experiment." *Nature News*, Nature Publishing Group, 18 July 2019, www.nature.com/articles/s41598-019-43323-2. Accessed 2024
- [7] Born, Max. "Statistical Interpretation of Quantum Mechanics." *Science*, 14 Oct. 1955, www.science.org/doi/abs/10.1126/science.122.3172.675. Accessed 2024
- [8] Domellen, Leon van. "2.6 Hermitian Operators." *Quantum Mechanics for Engineers*, web1.eng.famu.fsu.edu/~dommelen/quantum/style\_a/herm.html. Accessed 2024.
- [9] Brown, Arlen, and Carl Percy. "Structure of Commutators of Operators." *JSTOR*, www.jstor.org/stable/1970564. Accessed 2024.
- [10] Robertson, H. P. "The Uncertainty Principle." *Physical Review Journals Archive*, American Physical Society, 1 July 1929, journals.aps.org/pr/abstract/10.1103/PhysRev.34.163.
- [11] Nave, Rod. "Time Dependent Schrodinger Equation." *Schrodinger Equation*, HyperPhysics, hyperphysics.phy-astr.gsu.edu/hbase/quantum/Scheq.html#c4. Accessed 2024.
- [12] *Infinite Square Well*, University of New Mexico, physics.unm.edu/Courses/Fields/Phys491/Notes/TISEInfiniteSquare.pdf. Accessed 2024.

## Tracing Back Lines in the Sand: The Forces Behind the Sykes-Picot Agreement by Filiz Fish

Today's world bears the scars of colonialism's indelible grip. Africa wears the borders drawn by its colonizers while other regions continue to define themselves by the names imposed upon them for centuries. Though colonialism holds a footing in nearly every crevice of the globe, one of its most profound impacts on the modern map can be traced back to the Sykes-Picot agreement and Europe's conquest of the Ottoman Empire. The clandestine treaty, orchestrated by Britain and France in the final years of World War I, shaped the trajectory of history through its radical division of the Middle East into seemingly random sects of land. While several factors contributed to the Sykes-Picot agreement, Britain and France's fixation with prestige, Social Darwinist ideology, and the West's portrayal of imperialism as a civilizing act (known as the white man's burden) served as the driving forces for Europe's careless division of the Middle Eastern map.

Established in the early 13th century, the Ottoman Empire encompassed territory from the Balkans to the North, North Africa to the West, and eastward into the Caucasus and Anatolia. The empire reached its influential zenith during the 16th century under the rule of Suleiman the Magnificent, the reigning sultan who harkened an era of prosperity and success by establishing a unified legal system; however, the Ottoman Empire began its descent in the 1700s as its military prowess dwindled in comparison to its industrialized Western counterparts.<sup>1</sup> Additionally, the empire lost previously subservient territories such as modern-day Greece, Romania, Serbia, and Bulgaria to its foreign enemies, which, coupled with its failed invasion of Iran, weakened the empire's breadth and imperial might.<sup>2</sup> Allied with Germany and the Austro-Hungarian Empire, the Ottomans entered World War I with existing fissures that the protracted conflict exposed and exacerbated. Thus, predicated on the assumption that they could defeat the declining power, Britain and France convened and divided Ottoman territory among themselves before the empire's official end in 1922.

British and French diplomats Mark Sykes and François Georges-Picot negotiated the contours of the newly emerging Middle East until, on May 16, 1916, the two signed a treaty of their namesakes that delineated the land into "spheres of influence" — regions where each power would have political, economic, and military control. The agreement began with a distinct division of the territory, reading "in area (A) France, and in area (B) Great Britain, shall have priority of right of enterprise and local loans."<sup>3</sup> Spurring a decade of colonial intervention in the region, the Sykes-Picot Agreement laid the foundations of the first Middle Eastern states to rise from the ashes of the Ottoman Empire.<sup>4</sup> A number of forces propelled Britain and France to

---

<sup>1</sup> Bernard Lewis, "Some Reflections on the Decline of the Ottoman Empire," *Studia Islamica*, no. 9 (1958): 116, <https://www.jstor.org/stable/1594978?seq=2>

<sup>2</sup> Lewis, 114.

<sup>3</sup> Susan R. Grayzel, *The First World War : A Brief History with Documents*. (New York: Bedford/Saint Martin's, 2013), 140.

<sup>4</sup> Robin Wright, "How The Curse of Sykes-Picot Still Haunts the Middle East," *The New Yorker*, April 30, 2016, 1, <https://www.newyorker.com/news/news-desk/how-the-curse-of-sykes-picot-still-haunts-the-middle-east>,

usurp power in the Middle East: the Ottomans' waning influence and heightened vulnerability, access to Mediterranean trade routes, and the region's abundance of natural resources, namely oil.<sup>5</sup> Yet, while such factors incentivized the two nations to pursue colonization, they were not at the crux of the West's motivation for reconstructing the Middle East.

The driving impetus behind the Sykes-Picot agreement stemmed from Britain and France's desire to calcify their prestige as colonial powers. Europe had been attuned to its global reputation since the emergence of imperialism in the 15th century, maintaining a vested interest in projecting political supremacy.<sup>6</sup> As colonialism came to represent a tangible manifestation of power, countries like Britain and France naturally gravitated towards conquest.<sup>7</sup> Britain, in particular, displayed a strong and seemingly perennial avarice for accruing status. John Ruskin, an English intellectual and social reformer, summarized Britain's colonial attitudes as he addressed Oxford University in the late 1800s:

[Will the] youths of England, make your country again a royal throne of kings...(T)his is what [England] must either do or perish: she must found colonies as fast and as far as she is able to, formed of her most energetic and worthiest men; -- seizing every piece of fruitful waste ground she can set her foot on, and there teaching these her colonists...that their first aim is to be to advance the power of England by land and by sea.<sup>8</sup>

Ruskin encapsulated Britain's desire to maintain its reputation as a historic imperial power, identifying colonialism as the primary mechanism to achieve cachet on the geopolitical stage. While Ruskin spoke before the advent of World War I in 1914, his rhetoric echoed through the Sykes-Picot agreement.

Presenting his vision of the Middle East to British Prime Minister H. H. Asquith, Sykes famously said, "I should like to draw a line from the 'E' in Acre to the last 'K' in Kirkuk."<sup>9</sup> His brash justification elucidates the arbitrariness with which he and Picot contrived their borders — no more precise than tracing their fingers across a map. For that very reason, scholars often refer to the boundaries of Britain and France's Middle Eastern map as "lines in the sand," shaped carelessly and at the will of colonialist powers. The two did not feign cognizance of the region's heterogeneity, the varying ethnic, religious, and cultural demographics, when delineating their respective territories. Though he would be shaping the contours of Middle Eastern history, Sykes spoke with palpable disregard toward the Middle Eastern people, for Britain and France were not interested in the internal volatility of their map so long as their "spheres of influence" fed their colonial voracity. As Yale historian Jonathan Wrytzen argued, Europeans, teeming to maximize

---

<sup>5</sup> M. E. Yapp, *The Making of the Modern Near East 1792-1923*, 1987, 301.

<sup>6</sup> There is no precise date to mark the beginning of imperialism, though scholarly sources consider the period known as "Old Imperialism" to have begun in 1450. "Old Imperialism" eventually evolved into "New Imperialism," which best describes the actions taken by Britain and France to assert power over the Middle East

<sup>7</sup> Julian Go, "Capital, Containment, and Competition: The Dynamics of British Imperialism, 1730–1939," *Social Science History* 38, no. 1–2 (2014): 45, <https://www.jstor.org/stable/90017018>.

<sup>8</sup> From a speech given by John Ruskin at Oxford University, February 8, 1870.

<sup>9</sup> Wright, "Sykes-Picot Haunts the Middle East," 2.

their power by expanding into the fallen Ottoman Empire, shunned the wants of the region's residents.<sup>10</sup>

Sykes-Picot was a particularly symbolic project for Britain and France as it allowed them to assert authority over the very force that threatened their quest to become the world's dominant powers.<sup>11</sup> An eastern, Islamic empire had rivaled Europe for centuries, challenging the prestige and repute of Western colonial forces, tarnishing the self-esteem of countries that presumed themselves to be innately superior.<sup>12</sup> Reflecting on Western influence in the Middle East, Palestinian-American author and post-colonial theorist Edward Said wrote, "For Egypt was not just another colony; it was the vindication of Western imperialism."<sup>13</sup> This sentiment captured the essence of the Sykes-Picot agreement — a relentless pursuit to assert dominance and validate the ego of not only Britain and France but Western civilization at large.<sup>14</sup>

Alongside their pursuit of perceptual dominance, Britain and France wielded Social Darwinism to justify their imperialist endeavors. There had long been a binary between the East and West, where, in the eyes of Western nations, Europe signified intellect and power while Islamic nations epitomized antiquity and racial inferiority.<sup>15</sup> In 1908, Lord Cromer, an English representative in colonial Egypt, published his novel *Modern Egypt*, in which he wrote,

Want of accuracy, which easily degenerates into untruthfulness, is in fact the main characteristic of the Oriental mind. The European is a close reasoner; his statements of fact are devoid of ambiguity he is a natural logician... Although the ancient Arabs acquired in a somewhat higher degree the science of dialects, their descendants are singularly deficient in the logical faculty.<sup>16</sup>

Baring's portrayal of the "Oriental mind" exemplifies the Social Darwinist tenet that labeled societies as modernized and worthy to wield power or ill-equipped to adapt to the ever-changing world. Surrounded by a culture that placed Middle Eastern traits in opposition with European advancements, Britain and France, the "close reasoners" with statements of fact devoid of ambiguity," saw no qualms with dissecting the land of those "singularly deficient in the logical faculty."<sup>17</sup> In short, there was a prevailing sentiment that deemed Anglo-Saxon culture biologically superior.

Britain readily embraced this thinking, as evinced by the stratification of its colonies into ranked "mandates" —colonized land overseen by the League of Nations— following the

---

<sup>10</sup> Jonathan Wyrzten, interview by David Cummings, Yale News, November 17, 2022, 1, <https://news.yale.edu/2022/11/17/long-great-war-and-roots-modern-middle-east>.

<sup>11</sup> Yapp, 303.

<sup>12</sup> Yapp, 303.

<sup>13</sup> Edward W. Said, *Orientalism*, (New York, NY: Vintage, 1994), 35.

<sup>14</sup> Yapp, 303.

<sup>15</sup> Said, *Orientalism*. The thesis of Edward Said's *Orientalism* centers around the binary between the East and West, thus there is no explicit page number on which the concept is cited. Rather, it permeates the entire work.

<sup>16</sup> Said, 38.

<sup>17</sup> Said, 38.

Sykes-Picot agreement.<sup>18</sup> The nation placed its subservient territories into varying social classes determined by a region's level of civilization and its cultural makeup.<sup>19</sup> While Arab nations were deemed class A mandates, with Black Africans and Pacific Islanders classes B and C, respectively, the very presence of this classification underscored the hierarchical notions central to European imperialism.<sup>20</sup> Such a framework enabled Britain and France to exploit and subjugate those from lower divisions who had not yet reached the intellectual or militaristic pedigree of modernized nations such as themselves. In the eyes of the West, it was ontologically pre-determined that the mightier British or superior French take dominion over the weak and less adaptive East; colonizing this population could not be considered immoral since it was simply the natural order of the world, a repetition in the intrinsic pattern of conqueror and conquered.

Like the combative rhetoric of Social Darwinism, Europe justified its colonialist efforts by portraying its invasion of the Middle East as a humanitarian act of civilization. Western nations, including Britain and France, have historically employed this rhetoric to dilute the harms of their imperialist conquests. British poet Rudyard Kipling's 1899 seminal work, "The White Man's Burden," reflects Europe's attitude toward colonialism during the time, painting colonization as a noble burden borne by the white race for the benefit of lesser, barbaric peoples. Kipling's argument undergirded British imperialism in Africa, where the nation used the narrative of "The White Man's Burden" to frame its occupation of the continent as a mission to bring civilization and modernity to ostensibly backward societies. Beneath its surface of altruism, the poem exposed the paternalistic and condescending attitudes that fueled colonialism, reinforcing notions of racial superiority and the right of European powers to dominate and exploit non-Western demographics. Said synthesized the idea when he wrote,

They are a subject race, dominated by a race that knows them and what is good for them. Their great moments were in the past; they are useful to the modern world only because the powerful and up-to-date empires have effectively brought them out of the wretchedness of their decline and turned them into productive colonies.<sup>21</sup>

Not only did Europe flagrantly impose its authority upon its colonies, but it derived moral satiation from framing its imperialist undertakings as philanthropic.

The same Western condescension manifested in the years prior to the Sykes-Picot agreement. A distorted image of the Islamic world had permeated European culture for decades, perpetuated through avenues such as art and literature. French painter Jean-Auguste-Dominique Ingres's "The Turkish Bath" exemplifies Europe's propagandized, Orientalist depiction of the East as a mysterious and unrefined realm in need of Western intervention.<sup>22</sup>

---

<sup>18</sup> Ussama Makdisi, interview by Daniel Denvir, Jacobin Magazine, March 22, 2024, 1-2, <https://jacobin.com/2024/03/west-colonialism-middle-east-ussama-makdisi>.

<sup>19</sup> Makdisi, 1-2

<sup>20</sup> Makdisi, 1-2

<sup>21</sup> Said, 35.

<sup>22</sup> Sophia Smith Galer, "How art created stereotypes of the Arab world," BBC.com, February 28, 2022, 1, <https://www.bbc.com/culture/article/20191017-how-art-created-stereotypes-of-the-arab-world>.



“The Turkish Baths” by Jean-Auguste-Dominique Ingres

The painting portrays women bathing in the harem — a space often used in Western depictions of the Orient as it had come to represent the Islamic world’s crude practices.<sup>23</sup> Emphasizing ornate décor, voyeuristic poses, and partially clothed bodies, Ingres exoticized and eroticized the scene, presenting the Middle East as a hedonistic, backward realm. As such, Sykes and Picot’s argument — that it was heroic and virtuous for France and Britain to uplift the region from its barbaric practices — was no aberration in a culture where paintings like Ingres’s were commonplace.

Because the British and French acted with such authority and presumed they could better govern the Middle East than local Islamic populations, they squashed burgeoning political movements in the area when establishing their territorial claim. As the Ottoman Empire faced defeat in World War I, Woodrow Wilson was championing the principle of self-determination in the United States, arguing that members of the state should have autonomy over their sovereignty and overall political destiny.<sup>24</sup> Thus, eager to seize control of their identity from the ashes of their former ruler, local communities within the Middle East adopted Wilson’s political paradigm, hoping to form nation-states with their own authority. Sykes and Picot, however, reduced the Arab world to an ethnocultural monolith — a homogeneous population characterized by

---

<sup>23</sup> Galer, “Stereotypes of the Arab World,” 1.

<sup>24</sup> Anthony Whelan, “Wilsonian Self-Determination and the Versailles Settlement,” *The International and Comparative Law Quarterly* 43, no. 1 (1994): 99, <http://www.jstor.org/stable/760824>.

primitive and obscene practices — so that they could frame their imperialism as a benevolent civilizing mission. As such, it mattered not how the illogical locals wished to divide their land, for they did not possess the political literacy to make the decision themselves.<sup>25</sup> Arthur James Balfour, a British foreign minister who drew inspiration from the Sykes-Picot agreement when re-shaping the region to include a Jewish state, wrote in a memorandum, “In Palestine we do not propose even to go through the form of consulting the wishes of the present inhabitants of the country...”<sup>26</sup> Evidently, European imperialism was firmly rooted in the continent’s ability to dismiss colonized populations through the framework Kipling presented in “The White Man’s Burden.”

Like much of history, Europe’s dissection of the Middle East was born from nuance and complexity. Nevertheless, nationalist sentiment persisted as the primary catalyst for the Sykes-Picot agreement. France and Britain’s pursuit of great power, their Social Darwinistic thinking, and the Orientalist notion of “civilizing” the Islamic world through their colonization allowed the two powers to cast arbitrary borders without pushback from their governments or other European nations. Examining the factors that influenced Sykes-Picot becomes increasingly important as the Israel-Palestine conflict rages through the Middle East — dividing countries, college campuses, and households from across the globe — as it was ultimately Britain and France’s toxic map that spurred the dispute. Several are quick to ascribe blame to one party over another, many claiming that the Middle East is incapable of democratic rule, but few acknowledge the colonial history underpinning the region’s volatility. Only a comprehensive understanding of the forces that wrought modern-day dilemmas can breed informed dialogue in a world forever marred by its history — by two men whose lines in the sand sowed permanent consequences.

---

<sup>25</sup> Jon Hoffman, “Middle East Autocrats, Islamophobia, and ‘Reverse Orientalism,’” June 15, 2023, 1, <https://www.cato.org/commentary/middle-east-autocrats-islamophobia-reverse-orientalism>.

<sup>26</sup> Sharif Nashashibi, “Balfour: Britain’s Original Sin,” Al Jazeera, November 23, 2014, 1, <https://www.aljazeera.com/opinions/2014/11/4/balfour-britains-original-sin>.

## Works Cited

- Al Jazeera. 2024. "A Century on: Why Arabs Resent Sykes-Picot," <https://interactive.aljazeera.com/aje/2016/sykes-picot-100-years-middle-east-map/index.html#:~:text=The%20Sykes%2DPicot%20Agreement%20was,and%20Georges%20Picot%20of%20France.>
- Blanche, Ed. 2013. "Borders of Blood." *Middle East*, no. 446 (August): 14–18. <https://research.ebsco.com/linkprocessor/plink?id=7123785c-4305-3d23-ba3e-d13adfd0add8>.
- Burke, Edmund. "Orientalism and World History: Representing Middle Eastern Nationalism and Islamism in the Twentieth Century." *Theory and Society* 27, no. 4 (1998): 489–507. <http://www.jstor.org/stable/657837>.
- Dennis, Rutledge M. "Social Darwinism, Scientific Racism, and the Metaphysics of Race." *The Journal of Negro Education* 64, no. 3 (1995): 243–52. <https://doi.org/10.2307/2967206>.
- Galer, Sophia Smith. 2022. "How Art Created Stereotypes of the Arab World." BBC News. BBC. February 28. <https://www.bbc.com/culture/article/20191017-how-art-created-stereotypes-of-the-arab-world>.
- Go, Julian. "Capital, Containment, and Competition: The Dynamics of British Imperialism, 1730–1939." *Social Science History* 38, no. 1–2 (2014): 43–69. <http://www.jstor.org/stable/90017018>.
- Grayzel, Susan R. *The First World War: A Brief History With Documents*, New York: Bedford/Saint Martin's, 2013.
- Hoffman, Jon "Middle East Autocrats and Islamophobia: The Roots of Reverse Orientalism." Cato Institute, Commentary, June 15, 2023. <https://www.cato.org/commentary/middle-east-autocrats-islamophobia-reverse-orientalism>.
- Johnson-Roehr, S. N. "From Imperialism to Postcolonialism: Key Concepts." *JSTOR Daily*, August 12, 2022. <https://daily.jstor.org/from-imperialism-to-postcolonialism-key-concepts/>.
- Lewis, Bernard. "Some Reflections on the Decline of the Ottoman Empire." *Studia Islamica*, no. 9 (1958): 111–27. <https://doi.org/10.2307/1594978>.
- Makdisi, Ussama. "How the West Remade the Middle East." interviewed by Daniel Denvir. *Jacobin Magazine*, <https://jacobin.com/2024/03/west-colonialism-middle-east-ussama-makdisi>
- Nashashibi, Sharif, "Balfour: Britain's Original Sin." *Al Jazeera*, November 4, 2014. <https://www.aljazeera.com/opinions/2014/11/4/balfour-britains-original-sin>.
- Ruskin, John, Speech to Oxford University, February 8, 1870.
- Said, Edward W., *Orientalism*, New York, NY: Vintage, 1994
- The Metropolitan Museum of Art. "The Ottoman Empire," February 11, 2020. <https://www.metmuseum.org/learn/educators/curriculum-resources/art-of-the-islamic-world/unit-five/chapter-two/the-ottoman-empire>.



- Whelan, Anthony. "Wilsonian Self-Determination and the Versailles Settlement." *The International and Comparative Law Quarterly* 43, no. 1 (1994): 99–115.  
<http://www.jstor.org/stable/760824>.
- Wright, Robin, "How The Curse of Sykes-Picot Still Haunts the Middle East." *The New Yorker*, April 30, 2016.  
[https://www.newyorker.com/news/news-desk/how-the-curse-of-sykes-picot-still-haunts-t  
he-middle-east](https://www.newyorker.com/news/news-desk/how-the-curse-of-sykes-picot-still-haunts-the-middle-east).
- Wyrzten, Jonathan "The 'Long Great War' and the Roots of the Modern Middle East."  
Interviewed by Mike Cummings, November 17, 2022  
<https://news.yale.edu/2022/11/17/long-great-war-and-roots-modern-middle-east>.
- Yapp, M.E., *The Making of the Modern Near East, 1792-1923*. New York: Longman Inc., 1987

## Unmasking Norval Morrisseau's Forgeries: Cultural Appropriation by Austin Liu

Cultural appropriation perpetuates a cycle of exploitation by commodifying Indigenous artistic expressions without consent nor regard for their spiritual significance or cultural context.

For centuries, images depicting Indigenous peoples have been featured in newspapers, advertisements, and various other forms of media and print. Scholars during the late 1970s, 1980s, and 1990s critically analyzed these depictions and similar acts of appropriation as manifestations of colonialism. Through concepts of class, power, race, and gender, they explored how dominant colonial powers appropriated the practices and cultural items of colonized peoples (Historica Canada, 2020). Out of these discussions emerged the concept of cultural appropriation, now a significant topic in mainstream literature and art.

Historically, instances of cultural appropriation of Indigenous cultures can be traced back to anthropologists of the late 1800s and early 1900s, who sought to preserve what they believed to be dying cultures by taking artifacts that ended up in museums (Historica Canada, 2020). Today, this is considered a form of cultural appropriation, leading to efforts to repatriate these items.

For instance, the Mi'kmaq First Nation of Miawpukek, with support from the federal government and other allies, has requested the return of the remains of two Beothuk individuals from a Scottish museum taken in 1828 (Historica Canada, 2020). Furthermore, other early forms of appropriation included portrayals of Indigenous peoples spanning the 17th to the 20th centuries within art and literature, where many of these stereotypical images of Indigenous peoples have survived. Historian Daniel Francis has long argued the concept of the "Imaginary Indian," was indicative of how non-Indigenous Canadians have crafted a distorted image of Indigenous peoples — a representation of the culture and history of white settlers rather the reality of Indigenous populations (Historica Canada, 2020). Similarly, exhibitions of Indigenous cultures at late 19th-century and early 20th-century world fairs often perpetuated colonial stereotypes, presenting Indigenous peoples as "exotic" and "anti-modern," despite their claims of authentically portraying indigenous peoples and traditional ways of life (Historica Canada, 2020).

Settler colonialism continues as a contemporary issue, actively contributing to the ongoing erasure of Indigenous culture in Arts. This systemic problem extends to instances like Kate Spade allegedly stealing the design of a ribbon skirt from Indigenous artist Noah Pino. This ribbon skirt holds profound significance within Indigenous culture, serving as a symbol of resilience, identity, and ancestral honour. Kate Spade's Sunday Stripe Organza Midi Skirt — which retails for US\$328 — is a mid-length satiny-skirt with boldly-coloured stripes that vary in width (Passafiume, 2023). Many saw similarities with the skirt, Pino's design and ribbon skirts more generally. "It's not uncommon for brands to seemingly pull from Indigenous designs," Pino said, "but doing so removes the history and cultural significance of garments, like ribbon skirts, which are ways 'our people adorn ourselves' and express who they are" (Passafiume, 2023).

Walmart has faced similar criticism for selling clothing items that exploit Indigenous languages and perpetuate stereotypical representations on their merchandise. Small Indigenous business owner Chelsea-Marie Pettit, founder of Aaniin Retail Inc., based in Toronto, Canada, claims Walmart wrongfully stole Indigenous language and syllabic writing on its apparel from her brand, appropriating not only her own brand, but Indigenous culture as a whole (Al-Hakim, 2023). "Our Indigenous languages were taken away from Indigenous people... and many of our ancestors were abused or killed for speaking our native tongue," she added. "Indigenous people are trying to reclaim their language and non-Indigenous people shouldn't be doing that for us." (Al-Hakim, 2023).

Kate Spade and Walmart are examples of how Indigenous culture is commercialized for financial gain through the appropriation of Indigenous art. However, the extent of cultural appropriation doesn't stop there; the impact of Norval Morrisseau's art fraud has led to a significant devaluation of Indigenous art both economically and spiritually.

Anishinaabe artist Norval Morrisseau (1931–2007) is considered by many to be the Mishomis, or grandfather, of contemporary Indigenous art in Canada. According to the article "Norval Morrisseau: Life and Work" by Art historian Carmen Robertson, his life has been sensationalized in newspapers and documentaries due to his unique artistic style pushing the boundaries of visual storytelling (Robertson, 2016). The article explores how Norval Morrisseau originated the pictographic style, or what is commonly referred to as the Woodland School. Sometimes also referred to as "x-ray art," the Woodland style has since then been used by several well-known artists, including Daphne Odjig, Jackson Beardy and Alex Janvier (Hill, 2022), highlighting Morrisseau's widespread influence on Indigenous Arts. As the creator of the Woodland School of Art and a prominent member of the Indian Group of Seven, Morrisseau's influential style and significant advocacy work cemented his status as a living legend of Canadian art, an honor formally recognized in 1978 when he was awarded the prestigious Order of Canada.

In the early 2000s, Norval Morrisseau identified several forgeries sold as genuine pieces of his artwork. However, even after his passing, the issue of art fraud persisted, as highlighted by a well-known case from 2005 involving keyboardist Kevin Hearn of the Barenaked Ladies (Baird, 2015). CBC has covered how Hearn took legal action against Maslak-McLeod Gallery, who marketed the painting, alleging that they had sold him a fake Morrisseau painting. In that article, it was reported that he, along with Barenaked Ladies' tenor John McDermott, filed lawsuits against the gallery and its owner, Joseph McLeod, of Maslak-McLeod Gallery, for their purported role in selling counterfeit Morrisseau artworks (Allan, 2023). Although McDermott later dropped his lawsuit, Hearn's case proceeded, with a hearing scheduled in October 2017. Carmen Robertson, who has extensively studied Morrisseau's works, testified in the original 2017 trial that the signature on the back of the artwork Hearn purchased did not match those she observed in museums and private collections (Sandals, 2019). She, thus, concluded that the painting was not a genuine Morrisseau. However, the trial judge dismissed Robertson's expert testimony based on an unsupported theory and improperly acted as an art expert himself. In

2019, the Ontario Court of Appeal overturned the 2017 decision, citing the trial judge's improper rejection of expert testimony and lack of impartiality, leading to the case being sent back for a retrial in 2020. Despite the initial dismissal of the case, the Ontario Court of Appeal ruled in 2019 that the art gallery was indeed at fault, awarding \$60,000 in compensation to Hearn.

This specific painting was titled Spirit Energy of Mother Earth and was sold for \$20,000 to Hearn (CBC, 2020).



Spirit Energy of Mother Earth by Norval Morrisseau

Hearn's lawsuit spurred broader investigations into the prevalence of forged Morrisseau paintings. Between 4,000 and 6,500 forged Morrisseau works were estimated to have been created by fraudulent rings, as stated by Detective Sergeant Jason Rybak of the Thunder Bay police in a statement to TBnewswatch (Tremayne-Pengelly, 2023). With an average low value of around \$15,000 for each counterfeit work, the total estimated value of the fraudulent art reached approximately \$100 million, making it the largest art fraud case in world history, according to Rybak (Tremayne-Pengelly, 2023). The investigation into these forgeries spanned across Canada and the U.S., resulting in the seizure of more than 1,000 fraudulent works. The arrests in connection with this case reflected the dismantling of three distinct forgery groups, which had been operating since 1996, 2002, and 2008, respectively (Tremayne-Pengelly, 2023). Notably,

Benjamin Paul Morrisseau, the nephew of the late artist, was among the eight suspects implicated in one of the forgery rings (Allan, 2024). Allegedly recruited in 2002 to assist in creating the fraudulent works, Benjamin Morrisseau was described as a "fantastic painter" in his own right by Detective Rybak of the Thunder Bay Police Service in an interview with *The Toronto Star* (White, 2023). His motivations for allegedly participating in the art fraud scheme remain unknown.

"There is a misconception that art crime is a victimless crime and that people aren't getting hurt by it," said Kevin Hearn. The impact left by Norval Morrisseau's Art Fraud has changed the viewer's perception of Morrisseau's art. What should be a celebration of his work is now overshadowed by doubt and skepticism. "This, at a time of reflection on truth and reconciliation, makes it difficult for us to consider the purchase of works from [Canadian Indigenous Artists]," said the statement of a couple who spent thousands of dollars on fraudulent Morrisseau works recorded by Michelle Allan from CBC News. "We have lost any degree of confidence that we are directing our dollars and enthusiasm to those who deserve our recognition and support" (Allan, 2023). Jonathan Sommer, a lawyer who specializes in art forgery, estimates there are significantly more fraudulent works in circulation than genuine Morrisseau paintings: "They undermine the relationship between viewers of the art and who Morrisseau really was... And that, you know, a man whose work should be celebrated and we should look at in awe is now a work that whenever it's put on a wall, there's a question about it." (Sommer, 2016). This erosion of trust has also had significant financial consequences, with the flooding of the market with fake Morrisseau works leading to a depreciation in the value of his original paintings. The estimated losses in the estate's worth surpass a conservative estimate of over \$100 million (Kaufman, 2023).

However, despite these challenges, Morrisseau's enduring influence in Indigenous arts and the appeal of his renowned Woodlands style remain undiminished. Regardless of fluctuations in monetary worth, those who truly appreciate his work will continue to recognize its significance and value. Despite the setbacks caused by the fraud scandal, Morrisseau's contributions to Indigenous art continue to resonate and hold importance both today and into the future, to many.

However, "Morrisseau's influence is so pervasive that the impact of the fraud reverberates throughout the Indigenous art scene," (Allan, 2023). Erin Brillon, a Haida and Cree artist and business owner, has claimed that this issue will continue to persist, making it harder for authentic Indigenous artists, especially younger ones, to mark their place in the market (Beaulne-Stuebing, 2023). In cases like Norval Morrisseau's forgeries, the extremity — at which cultural appropriation can push — has shown us how popularity and legacy can contribute to enrichment and devastation. Forgery is not just a financial problem for artists and their heirs and collectors. It has also intruded on the reconciliation of vulnerable and historically oppressed Indigenous cultures (Baird, 2015). Ontario Regional Chief Glen Hare of the Chiefs of Ontario states that the fraudulent activity relating to Morrisseau's works is a form of cultural theft. "These forgeries have exploited our culture for criminal, financial gain" (Hare, 2023). Large-scale art fraud, such

as Norval Morrisseau's, highlights how financial gain can overshadow cultural preservation. The mass production of replicas has devalued the cultural significance of Indigenous Arts.

From the rise of appropriation from colonialism in the late 1900s to the current cases like Norval Morrisseau's forgery rings, it is a tragedy for the public at large, and for our evolving culture, to dilute the achievements of major artists and draw attention away from the nuances of their authentic work. "The problem is that Indigenous heritage is often seen as a public domain, free for the taking," said George Nicholas, a professor at Simon Fraser University who led an eight-year international research project on cultural appropriation (Nicholas, 2017).

It's important that Indigenous artists are compensated for their work and that art collectors and consumers should get what they pay for. Thus, I believe transparency in addition to repercussions should be implemented around Indigenous art forgeries. While it's clear that engaging in Art Fraud as a whole causes financial and ethical corruption, the level at which governments intervene requires judgment. In my ethical assessment, acknowledging smaller businesses only selling replicas inspired by popular artworks to make a living is important. Thus, I propose a policy giving Indigenous artists control over compensation for these sales, where replication is only allowed with proper authorization. Accused business owners without a formal contract indicating the signed agreement, are legally eligible to be charged against to restore compensation to Indigenous artists.

Implementing principles from The United Nations Declaration on the Rights of Indigenous (UNDRIP) can be beneficial in reclaiming Indigenous culture and rights in the Arts. UNDRIP, adopted in 2007, stands as a significant human rights document outlining the rights of Indigenous peoples worldwide. Within its 46 articles, Articles 11 and 31 specifically address cultural appropriation in the arts (Soule, 2018). Article 11 emphasizes the rights of Indigenous peoples to preserve and revitalize their cultural traditions and artifacts, including visual and performing arts, and calls for states to establish mechanisms for addressing cultural property appropriation (Soule, 2018). Article 31 ensures Indigenous peoples' control over their cultural heritage, traditional knowledge, and artistic expressions, including intellectual property rights (Soule, 2018). Many Indigenous artists advocate the implementation of these rights to challenge cultural appropriation. It is crucial to refer to UNDRIP at all levels of government (municipal, provincial, and federal) to protect Indigenous rights and promote reconciliation for Indigenous artists.

It is also essential to include insight from Indigenous law. "Listening to our First Nation elders or listening to people that understand Indigenous laws and seeking redress through those Indigenous legal forums is a very good starting point," said Whitehorse lawyer Claire Anderson (Anderson, 2017). This would successfully provide legitimacy and accountability for Indigenous perspectives and politics.

Another significant issue is the need for authentication capabilities. Gallery owners and consumers often need access to professionals who authenticate works from renowned artists. Especially for expensive paintings, there must be more reliable indicators of authenticity beyond a contract, paper form, or signature. Gallery owners should proactively verify the authenticity of

Morrisseau's works before heavy marketing and selling them. While it may not be directly their fault, gallery owners have a responsibility to ensure fair compensation and accountability for the authenticity of all artworks sold, adding another component to transparency.

Implementing policies to ensure compensation and providing accessibility to professional authentication are two major first steps to not only diminish art forgery but also foster an uncorrupt and trustful environment for seller-buyer relationships, especially in the art scene. Through this, we can safeguard the Indigenous art industry, preserve the legacies of individual artists, and ensure fair compensation, both financially and culturally.

“The one thing we kept alive through everything, through first contact, colonialism, residential school, the potlatch ban is our art,” Jay Soule AKA CHIPPEWAR, an internationally renowned Indigenous artist and advocate against cultural appropriation within the arts, says (Soule, 2018). “They took our language. They took our culture away. And this is the one thing we can hold onto — and now you want to take that too?.. I don't make a mask just to make a mask. I mean, you could wear it in a ceremony. And all these other people are just in it for the money.” (Soule, 2018).

## Works Cited

- Allan, M. (2023). Ringleader in Norval Morrisseau Art Fraud Ring to be Sentenced Thursday in Thunder Bay. CBC. Retrieved Jan. 24, 2024, from <https://www.cbc.ca/news/canada/thunder-bay/norval-morrisseau-art-fraud-sentencing-1.7058332>
- Allan, M. (2024). Norval Morrisseau fraud investigation leads to court case. CBC News. <https://www.cbc.ca/news/canada/thunder-bay/norval-morrisseau-fraud-investigation-court-1.7177419>
- Al-Hakim, A. (2023). Indigenous business calls out Walmart for shirt design. Yahoo News. <https://ca.style.yahoo.com/indigenous-business-walmart-shirt-205511104.html>
- Angel, S. (2023). Anatomy of a crime the norval morrisseau art forgeries. Retrieved Jan. 24, 2024, from <https://www.aci-iac.ca/wp-content/uploads/2023/04/art-canada-institute-newsletter-anatomy-of-a-crime-the-norval-morrisseau-forgeries.pdf>
- Baird, D. (2015). Norval morrisseau and the art of forgery. Retrieved Jan. 24, 2024, from <https://www.thecanadianencyclopedia.ca/en/article/norval-morrisseau-and-the-art-of-forgery>
- Beaulne-Stuebing, L. (2023). Why Tackling the Global Industry of Fake Indigenous Art is like Playing 'Whack-a-Mole'. CBC. Retrieved Jan 24, 2024, from <https://www.cbc.ca/radio/unreserved/fraudulent-indigenous-art-1.6774902>
- Bird, H. (2017). Indigenous culture not protected in Canadian law, lawyers and academics say. CBC News. <https://www.cbc.ca/news/canada/north/indigenous-culture-not-protected-in-canadian-law-lawyers-and-academics-say-1.4138794>
- Claw, R. (2016). Lawsuits allege norval morrisseau paintings fake. Retrieved Feb. 20, 2024, from <https://www.cbc.ca/news/canada/thunder-bay/lawsuits-allege-norval-morrisseau-paintings-fake-1.2520979>
- Day, G. (2014). Explaining the art market's thefts, frauds, and forgeries (and explaining the art market's thefts, frauds, and forgeries (and why the art market does not seem to care) why the art market does not seem to care). *Vanderbilt Journal of Entertainment & Technology Law* *Vanderbilt Journal of Entertainment & Technology Law*, 16:3:457(3), 458-494. Retrieved from <https://scholarship.law.vanderbilt.edu/cgi/viewcontent.cgi?article=1201&context=jetlaw>
- Dunseath, S., & Few, L. (Producers), & Ferri, J. (Director). (2023, Apr 19,). Restoring Norval Morrisseau's legacy. [Video/DVD] Ontario, Canada: TVO Today. Retrieved Jan. 24, 2024, from <https://www.youtube.com/watch?v=cNEaUTW7zpc>
- Fionda, F. (2018). Fake art hurts Indigenous Artists as Appropriators Profit. *The Discourse*. Retrieved Jan 24, 2024, from <https://thediscourse.ca/urban-nation/fake-art-indigenous>



- Friesen, J. (2020, January 29). Documentary 'There Are No Fakes' explores Norval Morrisseau art fraud. CBC News.  
<https://www.cbc.ca/news/canada/thunder-bay/there-are-no-fakes-tvo-1.5444756>
- Historica Canada. (2020). Cultural appropriation of Indigenous peoples in Canada. The Canadian Encyclopedia.  
<https://www.thecanadianencyclopedia.ca/en/article/cultural-appropriation-of-indigenous-peoples-in-canada>
- Hill, T. (2022). Norval Morrisseau. The Canadian Encyclopedia. Retrieved Jan. 24, 2024, from <https://www.thecanadianencyclopedia.ca/en/article/norval-morrisseau>
- Indigenous Services Canada. (2018). Canada's statement on the implementation of the United Nations Declaration on the Rights of Indigenous Peoples.  
<https://www.sac-isc.gc.ca/eng/1712932096213/1712932133185>
- Ketonen, K. (2023). 8 charged over 1,000 paintings seized in norval morrisseau art fraud investigation. Retrieved Jan. 24, 2024, from <https://www.cbc.ca/news/canada/thunder-bay/norval-morrisseau-forgery-1.6766990>
- Kirkup, K. (2024). Authenticity of Norval Morrisseau Painting being Investigated by National Capital Commission, OPP. The Globe and Mail. Retrieved Jan. 24, 2024, from <https://www.theglobeandmail.com/politics/article-authenticity-of-norval-morrisseau-painting-being-investigated-by/>
- Krueger, P. (1998). Counterfeit cultures: Cultural appropriation, Art by Native Artists. National Library of Canada, 1-24. Laurentian University, Sudbury, Ontario. Retrieved Jan. 24, 2024, from [https://central.bac-lac.gc.ca/.item?id=MQ31446&op=pdf&app=Library&oclc\\_number=1227875870](https://central.bac-lac.gc.ca/.item?id=MQ31446&op=pdf&app=Library&oclc_number=1227875870)
- Morrisseau, N. (1974). Spirit energy of mother earth. Oil Painting.
- Nelson, J. P. (2013). Framing the Picture: The Canadian Print Media's Construction of an Atypical Crime - Art Fraud - and its Victims, 1978-2012. (Master's thesis). University of Guelph, Guelph, Ontario, Canada.
- Passafiume, A. (2023). Kate Spade under fire for cultural appropriation for Indigenous ribbon skirt look-alike. Toronto Star.  
[https://www.thestar.com/life/kate-spade-under-fire-for-cultural-appropriation-for-indigenous-ribbon-skirt-look-alike/article\\_5971de6f-3665-5fba-bfc9-32eaa6458e4a.html](https://www.thestar.com/life/kate-spade-under-fire-for-cultural-appropriation-for-indigenous-ribbon-skirt-look-alike/article_5971de6f-3665-5fba-bfc9-32eaa6458e4a.html)
- Pes, J. (2018). It's not just art that indigenous people are fighting to reclaim from museums. they want their ancestors' remains back, too. Art Net. Retrieved Jan 24, 2024, from <https://news.artnet.com/market/its-not-just-art-that-indigenous-peoples-want-back-from-museums-they-want-their-ancestors-human-remains-too-1397737>
- Robertson, C. (2019). Expert report on the authenticity of a Norval Morrisseau painting. Norval Morrisseau Legal.  
[https://www.norvalmorrisseaulegal.com/wp-content/uploads/2019/04/Carmen-Robertson-expert-report-Hearn\\_compressed.pdf](https://www.norvalmorrisseaulegal.com/wp-content/uploads/2019/04/Carmen-Robertson-expert-report-Hearn_compressed.pdf)

- Robertson, C. (2016). *Norval morrisseau: Life and work*. Toronto, ON: Art Canada Institute.
- Sandals, L. (2019). Court's new Morrisseau forgery decision a big warning to art dealers. *Canadian Art*.  
<https://canadianart.ca/news/courts-new-morrisseau-forgery-decision-a-big-warning-to-art-dealers/>
- Straker, C. (Producer), & McKenzie, C. (Director). (2021, Jan 28,). *A Growing Number of "Pretendian" Artists and the Potential Repercussions* | InFocus. [Video/DVD] Winnipeg, Manitoba: APTN National News.
- Soule, J. (2018). Home | Reclaim Indigenous Arts. *Reclaim Indigenous Arts*. Retrieved Jan 24, 2024, from <https://www.reclaimindigenousarts.com/home>
- Tremayne-Pengelly, A. (2023). Canadian police make arrests in 'Biggest art fraud in world history'. Retrieved Feb. 20, 2024, from <https://observer.com/2023/03/canadian-police-make-arrests-in-biggest-art-fraud-in-world-history/>
- Kaufman, I. (2023). Norval Morrisseau forgery scheme described as 'biggest art fraud in world history'. *TBNewsWatch*.  
<https://www.tbnewswatch.com/local-news/norval-morrisseau-forgery-scheme-biggest-art-fraud-in-world-history-6646585>
- Wente, J. (2019). Cultural appropriation and the Canada Council's approach. *The Canada Council*. Retrieved Jan. 24, 2024, from <https://canadacouncil.ca/funding/funding-decisions/decision-making-process/application-assessment/cont-ext-briefs/cultural-appropriation>
- White, P. (2023). Print media criminalization of Indigenous art. Retrieved from <https://norvalmorrisseaulegal.com/wp-content/uploads/2023/12/print-media-criminal-1.pdf>
- Willmott, G. (2004). Modernism and aboriginal modernity: The appropriation of products of west coast native heritage as national goods. *Essays on Canadian Writing*, (83), 75-139. Canadian Literary Centre. Retrieved Jan. 24, 2024, from <https://search.ebscohost.com/login.aspx?direct=true&AuthType=sso&db=cjh&AN=18277752&site=eds-live&custid=s2136745>

# **The Connection Between School Shooters and Adverse Childhood Experiences By Navya Saravanakumar**

## **Abstract**

The prevalence of school shooters who have experienced a troubled childhood suggests a connection between Adverse Childhood Experiences (ACEs) and school shootings. ACEs consist of both mentally and physically damaging experiences. Previous research (Forster et al. 2017; Dowdell et al. 2022) demonstrates a link between ACEs and the likelihood of perpetrating violence. Such research suggests that though the connection exists, there are still other perspectives that must be taken into consideration. This literature review aims to examine the connection from two perspectives—the likelihood of a shooter having an ACE versus the likelihood of someone with an ACE becoming a shooter. While one point of view may be accurate, the reverse may not necessarily be true; that is, we do not know the precise likelihood that someone with an ACE will become a school shooter. At the same time, both can exist simultaneously and both aspects are important to consider when addressing school shootings.

## **Introduction of ACEs**

ACEs are a broad term that can have many categories to be divided into. Some can be in terms of violence and physical acts, while others can be more mentally damaging (Soares, Santos, and Fraga 2022). They also encompass a range of severity. For the purpose of this review, ACEs will be defined as any kind of traumatic experience that occurred during the ages of 0-17. Traumatic experience can also have varying definitions, but in this paper, it is defined as an event or circumstance that results in physical, emotional, or life-threatening harm. There are traumatic experiences that can be considered severe such as witnessing or experiencing physical abuse, violence, or neglect within the family, and these experiences can have a bigger mental or physical impact on someone compared to less severe ACEs (Soares, Santos, and Fraga 2022). Another one of the most common ACEs is bullying (Soares, Santos, and Fraga 2022). Bullying, defined as a subset of aggressive behavior that involves an intention to hurt another person, has many specific factors that are similar to other ACEs (Hornor 2018). One of those factors is the impact it can have on victims, specifically on the development of mental illnesses, such as psychiatric disorders, and physical health problems, such as cancer and heart disease, later in adulthood (Hornor 2018; Soares, Santos, and Fraga 2022). Many people who have experienced an ACE experience mental health difficulties, engage in violent behavior, or become a victim to violence in adulthood (Soares, Santos, and Fraga 2022).

## **Method: ACE Scoring**

In order to understand the value of the ACEs, they can be quantified, measured, and compared using a scoring system (Anda, Porter, and Brown 2020). An ACE score is calculated based on the number of "yes" responses to a questionnaire, where a series of 10 questions that reflect 10 different types/categories of ACEs are given.

Many researchers have identified a strong relationship between the scores and health and social outcomes, including drug use, suicide risk, and risk of diseases (Anda, Porter, and Brown 2020). ACE scoring can also be useful for studying toxic-stress physiology (Anda, Porter, and Brown 2020). In this study, the ACE scores were combined with a list of 35 health conditions, marked by either its presence or absence. They used this method in order to group clients into low, medium, and high-risk categories for the study (Anda, Porter, and Brown 2020).

Although the scoring clearly has positive utility in many studies, like the one previously mentioned, there are many disadvantages to the scoring, including certain characteristics that the scoring lacks. This way of scoring does not do a good job of capturing nuances in a person's childhood, especially if they have had multiple ACEs in a single category. For example, if someone is bullied by 2 different people at 2 different times, they would only have a score of 1 because there is only one question about bullying, which would be something along the lines of, "Have you been bullied before?" This makes it so you cannot see the number of ACEs within a single category or the intensity of the trauma experienced (Anda, Porter, and Brown 2020). The ACE scoring is also unable to account for sex differences or differences in the timing of exposure (Anda, Porter, and Brown 2020). The timing of exposure, specifically, could be significant because mental stability and stress can vary according to age. For example, one would not be able to differentiate between someone with an ACE score of 1 where the trauma was a high-intensity experience and someone with an ACE score of 5 but from lower-intensity experiences. Clearly, in order to figure out how those experiences influence the person based on the presence or absence of them, a more detailed form of measurement is needed (Anda, Porter, and Brown 2020). Another limitation of the ACE scoring is the interpretation of the scoring by the general public. Many people often misuse the ACE scores as a tool to diagnose or screen themselves (Anda, Porter, and Brown 2020). This misusing can also lead to misapplications in treatment research, where it inaccurately assigns the risk of certain health outcomes (Anda, Porter, and Brown 2020). Though the scoring cannot be used for certain applications, it would be beneficial to study this relationship and identify in what situations it can be used in (Anda, Porter, and Brown 2020).

## **Results**

### **Demographics of School Shooters**

In terms of the breakdown of those who have committed school shootings, Dowdell et al. provides valuable data on the prevalence of ACEs (Dowdell et al. 2022). For this study, the researchers selected a sample of 25 American males who committed a school shooting to analyze and study. They found that the average age of the shooter was approximately 17 years old. 15 (60%) of them had survived the shooting that they had started. 9 (36%) of them had a reported psychiatric disorder. As for the connection with ACEs, 15 (60%) of them had experienced bullying at some point in their lives. 22 (88%) of them had active social media accounts prior to going through with the shooting. 19 (76%) of them posted an alarming threat or message via some social media platform prior to their shooting. 18 (72%) of them posted a threat, prior to the

shooting, through a means not involving social media. The study also broke down the social media statistics as well as the psychiatric disorders more specifically. 9 (36%) of the shooters posted their threat on Facebook, and 8 (32%) of the shooters posted a threat on Instagram prior to the shooting. 2 (8%) of them used Twitter to post their threat and 4 (16%) of them used YouTube as their way of expression. Snapchat was another platform used by 7 (28%) of the shooters, and other forums and media varieties were used by 5 (20%) of the shooters. Aside from the social media distribution, many of them were diagnosed with specific psychiatric and neurodevelopmental disorders. 5 (20%) of them had mood disorders, 4 (16%) of them had autism spectrum disorder, and 2 (8%) of them were diagnosed with attention-deficit/hyperactivity disorder (ADHD). One of the most striking findings from this study was that the outcome of the shooter (whether they survived or were killed) was associated with the activity of their social media and the posting of gun photographs. This shows how there are many connections to be made between factors, such as social media, within a given school shooting. Another connection that can be made involving social media is with the activity of the shooters. Most shooters did post on their social media platforms before they followed through with the shooting.

### **Results: Two Points of View**

#### **Shooter → ACE or ACE → Shooter**

From the statistics mentioned in the previous paragraph, we are able to notice a clear connection between ACEs and school shooters. This can be concluded from the fact that in the general population, about 42.9% of the testing sample had experienced four or more ACEs (Soares, Santos, and Fraga 2022), whereas, amongst a sample of shooters, 72% of them experienced at least one ACE (Dowdell et al. 2022). There are two points of view with which to consider this relationship. The first perspective is the likelihood for a shooter to have had an ACE. The other perspective is the likelihood for someone with an ACE to become a shooter. As for the first point of view, the number of shooters that have reported to have an ACE is a large percentage, around 72-75% depending on the study (Dowdell et al. 2022). Specifically, of 25 male shooters, 18 of them had an ACE. 8 of them had one ACE, 5 of them had two ACEs, and 5 had either three or four ACEs. In addition to this, more than half of the sample reported experiences of bullying. The fact that almost 75% of those included in the study had an ACE provides a snapshot of the connection. The second point of view, the likelihood of someone with an ACE to become a shooter, does not have many statistics available to show the direct connection, though connections between cyberbullying and ACEs have been observed (Nagata et al. 2022). According to a study, adolescents who have experienced ACEs are at greater risk for experiencing bullying, which, as previously mentioned, has a connection to school shootings. Although this pinpoints a specific kind of bullying (cyberbullying), the effect is still relatively similar, but the likelihood for someone with an ACE to become a shooter is still not certain (Nagata et al. 2022).

### **Conclusion**

From these findings, it is clear that there is action to be taken in order to prevent further tragedies from taking place. One of the methods to do so is to increase screenings, specifically those performed by skilled professionals, for ACEs. The more screenings for ACEs, the more identification of those ACEs can happen. But, in order for this to be effective, the screenings should be improved to where they can detect the severity and frequency of ACEs and incorporate that into the scoring. Along with this, anyone who has experienced at least one ACE should be further assessed to determine whether or not they require additional resources. This further analysis will allow people to receive the appropriate resources to help aid them in dealing with the inevitable effects of adverse childhood experiences. This proactivity on these fronts can help prevent the possible escalation of an ACE into something tragic. Another change that could help with the furthering of the knowledge in this connection between ACEs and school shooters would be more longitudinal studies that follow the life of people who have experienced ACEs. This would allow for more information regarding the likelihood for someone with an ACE to become a shooter.

### Works Cited

- Anda, Robert F., Laura E. Porter, and David W. Brown. 2020. "Inside the Adverse Childhood Experience Score: Strengths, Limitations, and Misapplications." *American Journal of Preventive Medicine* 59 (2): 293–95. <https://doi.org/10.1016/j.amepre.2020.01.009>.
- Dowdell, Elizabeth Burgess, Erin Freitas, Alanna Owens, and Meredith MacKenzie Greenle. 2022. "School Shooters: Patterns of Adverse Childhood Experiences, Bullying, and Social Media." *Journal of Pediatric Health Care* 36 (4). <https://doi.org/10.1016/j.pedhc.2021.12.004>.
- Forster, Myriam, Amy L. Gower, Barbara J. McMorris, and Iris W. Borowsky. 2017. "Adverse Childhood Experiences and School-Based Victimization and Perpetration." *Journal of Interpersonal Violence* 35 (3-4): 088626051768988. <https://doi.org/10.1177/0886260517689885>.
- Honor, Gail. 2018. "Bullying: What the PNP Needs to Know." *Journal of Pediatric Health Care* 32 (4): 399–408. <https://doi.org/10.1016/j.pedhc.2018.02.001>.
- Nagata, Jason M., Nora Trompeter, Gurbinder Singh, Julia Raney, Kyle T. Ganson, Alexander Testa, Dylan B. Jackson, Stuart B. Murray, and Fiona C. Baker. 2022. "Adverse Childhood Experiences and Early Adolescent Cyberbullying in the United States." *Journal of Adolescence*, November. <https://doi.org/10.1002/jad.12124>.
- Sanders, Cheryl E. 2004. "What Is Bullying?" *Bullying*, 1–16. <https://doi.org/10.1016/b978-012617955-2/50004-7>.
- Soares, Sara, Ana Cristina Santos, and Sílvia Fraga. 2022. "Adverse Childhood Experiences, Bullying, Inflammation and BMI in 10-Year-Old Children: The Biological Embodiment." Edited by Abraham Salinas-Miranda. *PLOS ONE* 17 (8): e0273329. <https://doi.org/10.1371/journal.pone.0273329>.

## **Adelaide Smith Casely Hayford: Charisma and Circumstance by Lyanne Luu**

Adelaide Casely Hayford was an African symbol of feminism and cultural pride; her success in opening a girls' school and her presence at public engagements were celebrated. She was cherished by the Creole and even the British community of Sierra Leone. Adelaide possessed a presence and charisma that persuaded those around her of her zeal for feminism and culture. Her most valued proposition in her ultimately successful endeavor to advance her feminist and nationalist motives was her personality itself. A growing hub of nationalist values, early 1900s, Freetown revered Adelaide's passion to foster an environment for girls uplifting their culture and societal worth. During the late 1880s, the Creole elite community began to adopt Edward W. Blyden's philosophy toward identity, which "stressed the importance of the Negro [my emphasis] personality" and "the need to develop Negro [my emphasis] qualities" (Cromwell, 1986, p.14). The Creole elite were turning away from an identity as "Black Englishmen" and, instead, realizing the value of African culture and tradition (Cromwell, 1986, p.14). Thus, nationalism in Sierra Leone was focused on reclaiming and emphasizing black identity and cultural pride within Sierra Leone's Creole elite. Adelaide's Girls Vocational School maintained these nationalist values of Creole society and introduced opportunities for women previously neglected. Her eminence allowed for the embrace of her school and its founding principle: feminism. Her feminism, like her nationalism, was specific to Sierra Leone. Having obtained a high education and holding a strong value in the importance of education, Adelaide was dedicated to the betterment of schooling standards for girls in Freetown (Casely-Hayford, 1983, p.8). Her feminism's aim was specific to the girls of Freetown; she focused solely on increasing their economic independence and providing educational opportunity with the goal of "plac[ing] African women beside their Western counterparts" (Okonkwo, 1981, p. 51). In Europe, Adelaide received a thorough education; in turn, she hoped to offer Sierra Leonean girls the same equal opportunity she received. Adelaide captivated whatever room she was in, convincing donors, officials, and common people to join her cause— and most of the time, they did. However, was her success a true symbol of a turning point for feminism in 1900s Sierra Leone, a testament to the impact that a charismatic and captivating personality can have, or perhaps both?

Surely, Hayford was not the only woman passionate about broadening the scope of girls' education and introducing more opportunities to them. Previous endeavors to promote girls' education had either been short-lived or did not fulfill the aspects of professional training Adelaide later achieved (Cromwell, 1986, p.20). CMS (the Church Missionary Society) established the Annie Walsh Memorial School with the aim of training girls to become "integrated members of their communities and as real partners to their menfolk" (Cromwell, 1986, p.21). Bearing similar feminist motives to Adelaide's ideology, the Annie Walsh school paved the way for creating higher education standards for girls. However, the Annie Walsh school lacked African administration and cultural focus (Cromwell, 1986, p.21). Despite other women's efforts to provide stronger female education it was Adelaide who became a symbol of



female African pride and a catalyst for the feminist movement. She began her endeavor to open the Girls' Vocational School in 1920. By 1923, the school was operating in full force and encapsulated all of Adelaide's feminist, culturalist, and nationalist values (Okonkwo, 1981, p. 42). Freetown publications and communities praised and celebrated the school's diversified and creative curriculum. In three short years, Adelaide's goal had become nothing short of achieved. The Creole community's embrace and encouragement of nationalist viewpoints created an environment accepting of Adelaide Casely Hayford's endeavor to open the Girls Vocational School. Adelaide's identity's maintaining both feminist and culturalist values, along with her captivating and determined personality made her the ideal figure to bridge nationalist and feminist ideologies in 1900s Freetown.

Adelaide's identity as a Creole elite and her family's position in society instilled a dedication in her to the Creole girls of Sierra Leone. Like many other affluent Creole families in the late 1800s, Adelaide's family left Freetown and moved to England to educate their children. The Hayfords belonged to a highly selective, affluent group: the Creole elite (Cromwell, 1986, p.5). As members of the Creole elite, the Hayfords "enjoyed the same activities one would find in Britain," such as "cricket matches, choral and dramatic series," and other typical European hobbies (Cromwell, 1986, p.9). Upon arriving in Freetown in 1914, Adelaide possessed a direct connection to the Creole elite there as her half-brother, Dr. Robert Smith, resided among all high-ranking members who lived "within a few blocks of each other in downtown Freetown" (Cromwell, 1986, p.9). Adelaide and her family were at the center of the elite Creole community; in fact, Cromwell writes, "her relatives... represent every major thread from which the fabric of Creole society was woven" (Cromwell, 1986, p. 39).

Despite Adelaide's being raised in Europe from ages four to seventeen, she always felt a connection her her African motherland. Adelaide cherished her childhood and education in England; however, she admits that "in a white country, I felt so conspicuous" Cromwell, 1986, p.39). Her discomfort and her intensified "race-conscious[ness]" encouraged her desire to return to Sierra Leone and surround herself with fellow Africans. Furthermore, her dark complexion "allied her, in a very special way, with her mother," who considered Sierra Leone her home over England (Cromwell, 1986, p.39). Although the Hayfords practiced a British lifestyle and European social graces, Adelaide's parents maintained close connections to their homeland of Freetown. Adelaide's desire to return to Sierra Leone was in part to fulfill her "father's dying wish that we [Adelaide and her sister] should return to Freetown" (Casely-Hayford, 1983, p.19). Adelaide's family's loyalty and love for their homeland embedded in her a sense of devotion and pride for Freetown society.

The Creole community was favored by British authority throughout the 1800s due to their adoption of British lifestyle, education, and overall standards of life; however, when Adelaide arrived in 1914, "Freetown was a culturally fragmented society" (Cromwell, 1986, p.15). British authority in the 1800s was left unchallenged by the Creoles, as they felt "grateful to British philanthropy for freeing their ancestors from slavery" (Cromwell, 1986, p.8). The Creoles maintained a generally high regard for the European missionaries and colonial officers in

the ruling group, and the British, too, looked favorably on the Creoles throughout the early 1800s (Kandeh, 1992, p.90). The Creoles achieved their prominence among the English by assimilating to European occupational strategies to achieve economic well-being. The Creole community abandoned the outward practice of traditional indigenous customs like native dress and language, and they adopted European clothing, social graces, and education (Kandeh, 1992, p.90). Many Creoles' choice to continue indigenous practices privately while rejecting them in public highlights their willingness to submit to European expectations in hopes of achieving economic advancement and high stature. Conversely, their inward practice of African heritage also suggests that they maintained aspects of African pride and identity. The Hayford family exemplifies both the tension and intersection between African and British identity felt by the Creole community: Adelaide's family held great respect for their Sierra Leonean heritage, yet, they participated entirely in British activity and lifestyle. The British indeed celebrated the Creoles' assimilation, noting them as "model Africans who had leapt 'from cannibal to churchwarden'" (Hair, 1967, p.528). The Creoles became classified as a 'different type' of African— superior and more 'civilized' than other ethnic groups.

However, the Creole facade— their extreme public rejection of African culture and their adoption of British livelihoods— was fleeting, as was the British community's high opinion of them. The British community began to view the Creole's assumption of European life as an imitation rather than an embrace (Wyse, 1990, p.64). Unable to ever embrace a group of Africans entirely, the British community pivoted their opinion of the Creole from praise to pure mockery. Being called "ignorant savages posturing in European dress" by renowned author Richard Burton, the Creoles began to realize gaining British respect as an ethnic group was an ultimately unattainable task (Hair, 1967, p.529). Subsequently, the Creole community was "fragmented" in ideology: some mourning their "now lost status and equality" while others began to seek "new values and lifestyles to bring them closer to Africa" (Cromwell, 1986, p.15). Adelaide adopted the latter outlook; having always cherished her African roots, Adelaide persisted that African values and customs were essential to reclaim status and achieve societal advancement. British rejection suggested that a new outlook— one independent of European assessment and standards— must be recognized by the Creoles to pursue progress and advancement.

Creoles began to abandon notions of primitive Africa and realize African culture's intricacies and complexities. In 1854, Creole Missionary Koelle highlighted Bornu's (an indigenous language) grammar's "richness and inflection" and its demonstration of the intelligence of the "mind of the [African] people" (Hair, 1967, p.528). Through the acknowledgment of "cultural achievement" found in the intricacy of language— the foundation of a culture— the Creoles adopted the ideology that maintaining ethnic culture and community would foster economic and societal progress. By 1863, a recaptive (previously enslaved person) was elected into a Sierra Leonean legislative group for the first time (Hair, 1967, p.530). Samuel Crowther, another recaptive, was elected Bishop in charge of the Niger mission, for which he created the first missionary team of exclusively Creoles. Crowther facilitated the work of six Indigenous languages "to be put into writing" (Hair, 1967, p.531). Culturalism was increasing

not only in education and legislation but also in lifestyle. By 1881, some members of the Creole elite— including Adelaide in later years— belonged to a Dress Reform Society promoting the everyday wear of native clothing rather than Victorian style (Okonkwo, 1983). Adelaide entered Creole elite society as the community began to look within themselves and their identities as Africans to realize the potential of Freetown’s society independent from its ties with England. That the uprising in cultural values in the Creole community perfectly aligned with Adelaide’s cultural pride created a setting in which she and her ideas would be acknowledged and appreciated.

With the goal to embrace African culture and promote it as a modern means of societal progression came the condemnation of “‘foreign models’ for African education” and the idea that “the Negro and African should be raised upon his own idiosyncrasies” (Hair, 1967, p.534). Creole Clergyman James Johnson preached that a proper education must acknowledge “our peculiarities— our languages enriched by the traditions of centuries: our parables, many of them the quintessence of family and national histories” (Hair, 1967, p.534).

Adelaide Casely Hayford’s ideology concerning education included precisely the “quintessence” of African culture necessary to promote academic advancement and opportunities for women. Upon introduction to a “not very soul inspiring” education available to Creole girls, Hayford felt an “instant” responsibility to provide the “immediate need” for an “education which would instill into us a love of country, a pride of race, an enthusiasm for the black man's capabilities” (Casely-Hayford, p. 20). Her condemnation of the current standard for girls’ education and her hope that her students would know “the glory of black citizenship” demonstrated her commitment to promoting a future for Sierra Leonean youth independent of colonialist and Victorian influence and notions about Africa (Cromwell, 1986, p.102).

However, much more than passion and aspirations for the betterment of African education were necessary to bring Adelaide’s goal to fruition; it was her endless advocacy and determination that allowed for the success of her venture. As Hayford’s feminist agenda had preceded her nationalism, she was already president of the Ladies’ Division of the Freetown branch of the Universal Negro Improvement Association (UNIA) and was involved in other female groups (Cromwell, 1986, p.94). Her connection with such female groups allowed her to assemble and recruit other women to assist her in raising funds for the Girls Vocational School (Cromwell, 1986, p.94). However, Adelaide faced much opposition in her venture to obtain funds. A misunderstanding in her partnership with the UNIA left her with two options: dividing the funds between the organization and the school or proceeding without their support (Okonkwo, 1981, p.43). Her determination was so much so that she continued independently regardless of the school’s not being a “paying proposition” (Casely-Hayford, 1983, p.46).

The Sierra Leone Weekly News supported Adelaide’s venture, deeming that “there is hardly any place on earth where the true interest of women are neglected as in West Africa” (Okonkwo, 1981, p.43). The news outlet viewed Adelaide’s work as essential to the progression of female empowerment. However, the opposition and struggle Adelaide faced raising funds in Freetown demonstrated that the vision she held for her school required greater publicity and

funding than offered in Sierra Leone. Inspired and motivated by African American initiatives for racial justice and unity, in July of 1920, Adelaide traveled to America to collect money and obtain strategies for modern education for the school. She ignored any anxieties and apprehensiveness and embarked on “what was arguably the first fund-raising visit ever of an African woman” to over 35 American cities (Desai, 2004, p.35).

Throughout her public engagements during the trip, not only was Adelaide moved by the work of African American women, but she, too, was “most impressive” (Cromwell, 1986, p.116). Adelaide managed to be elected one of four vice presidents of the International Congress of Colored Women after spending less than a year in America, and received “warm” receptions from established institutions (Desai, 2004, p.35). Adelaide was able to inspire her audiences by overcoming and rejecting stereotypes about Africans. She ignored any stereotypes of ‘barbaric’ or ‘uncivilized’ Africa and spoke exclusively about African achievement, art, and culture (Casely-Hayford, 1983, p.36). Her speeches left audiences “overwhelmed with enthusiasm” for the potential of African girls (Casely-Hayford, 1983, p.36). She notes that people from all professions were willing to “deposit their dollar bills with such unstinted generosity” after listening to her speak (Casely-Hayford, 1983, p.36). Her ability to leave an impression and impact was so powerful that, at times, it did not even require her to speak. Upon visiting the Indianapolis Convention of Colored Women, Naomi Burroughs (the President of the convention) insisted that Adelaide “immediately” visit a photographer as her photograph would “sell like hot loaves” (Casely-Hayford, 1983, p.39). Furthermore, at her final engagement during her trip to the U.S., the President of the Tuskegee Institute insisted to Adelaide that “we generally allow a speaker only fifteen minutes, but you go on as long as you like” (Casely-Hayford, 1983, p.43). Adelaide enthralled her audiences by evoking a connection with them through her emphasis on Black identity; the relationship she built with them inspired them to appeal to her propositions. Two years after her leaving the Tuskegee Institute, the President still had a strong memory of Adelaide, writing that she was a “charming African woman... so strong and touching” (Cromwell, 1986, p.130). Her achieving such stature and obtaining the necessary funds to proceed with her school’s agenda in a limited time highlights the ability she had to captivate and influence those around her.

This quality to enthrall and motivate is precisely what made Adelaide the perfect proponent to introduce and accelerate feminist and nationalist values to Sierra Leonean education. Adelaide was a “symbol of African women in public life,” always dressed in her “picturesque African costumes” (Okonkwo, 1981, p.47). The Sierra Leone Weekly News described Adelaide’s venture as the “seed of an epoch” (Okonkwo, 1981, p.43). The fundraising difficulties she was facing were only a minor setback in an “epoch,” a series of successes that awaited her. Articles named her a “highly gifted” woman “clearly under a divine impulse and inspiration” (Okonkwo, 1981, p.43). Rather than focussing on the significance of her goals or the need to reconstruct African curricula to incorporate national history and culture, the media’s focal point was praise and appreciation for Adelaide’s character. It was her persona and her act to pursue these nationalist and feminist values that earned attention, not the values themselves.

Without Adelaide's determined and charismatic character, she likely would not have been able to secure the financial and media support that she did, considering that in opening the Girls Vocational School, she encountered even more obstacles. Because the school initially suffered from a lack of enrollment from high school girls, Adelaide was forced to reconstitute it as an elementary school (Desai, 2004, p.35). Hoping to compensate for the challenges of the school's opening, Adelaide embarked on a second fundraising campaign to the United States in 1927 (Desai, 2004, p.38). Yet again, her speeches and presence left a lasting and impactful impression. The Minutes of the League of Women for Community Service noted that Adelaide "proved a most interesting speaker," and members of the association "thought often of [her] school" even after Adelaide returned to Sierra Leone (Cromwell, 1986, p.131). Her newfound connections supplied her with the funds to permit a more successful reopening of the school; its running was able to continue despite limited enrollment until Adelaide's retirement.

Ultimately, the school did embody the aspects of nationalism and feminism that Adelaide strived for. Adelaide had wished to "see a school in which girls, instead of blindly copying European fashions, would be dressed in attractive native garments" (Cromwell, 1986, p.102). She fulfilled her hope through the school's "Africa Day," in which all students wore Fanti or other ethnic dress. Adelaide maintained that African attire instilled a "form of racial pride and would help us to foster a national spirit" and allowed women to express a "definite sign of their awakened patriotism" (Okonkwo, 1981, p.45). The school's "Africa Day" also remained devoted to nationalism through its sole concentration on African artwork, folk stories, history, and music (Okonkwo, 1981, p.42). Furthermore, Adelaide staffed her school with African teachers, utilized African textbooks, and taught African dance, music, and art with the goal of "educat[ing] and enlighten[ing] the African child without taking him too far way from his native environment" (Okonkwo, 1981, p.42).

The Girls Vocational School introduced a new ideology toward female education in Sierra Leone, as the few opportunities available to girls were confined to domestic training (Cromwell, 1986, p.24). Girls' education in Freetown had remained stagnant since the 1800s: "there was no novelty in thinking about the importance of girls' education for... Some girls had always received excellent education... abroad" (Cromwell, 1986, p.55). However, English education focused on literature as women were unlikely to enter clerical or commercial jobs due to the government's tendency to employ men in clerical positions and most firms' preference for male employees (Denzer, 1987, p.440). Adelaide's school, however, looked toward "a greater vision of usefulness for the girlhood of Freetown" (Cromwell, 1986, p.46). Although the growth of opportunities for women with impressive domestic skills and wives of men in political associations promoted some feminist values, prior to Adelaide's school, girls' education neglected professional training. In fact, in the Church Missionary Society's school girls' education was devoted to needlework and other domestic activity. That the little material they learned about literature, math, and geography was through stitching highlights the confinement of their education (Strickrodt, 2010, p.198). Adelaide's school's emphasis on professional

training and its encouragement of later economic independence created a new precedent for higher girls' education.

Her aspirations for African girls' education went beyond her vocational school; Adelaide lobbied that the implementation of cultural curricula in all West African schools would provide the betterment of African students' identity and future. She insisted that "the education of African girls needed to be taken seriously" (Okonkwo, 1981, p.46). Specifically, an education that prioritized pride in one's identity and taught skills that would advance women's opportunities and livelihoods leaving school. Adelaide's incorporation of African culture into the curriculum was not only due to her belief in nationalist viewpoints but also because of her belief that ethnic pride was a large factor in a woman's perception of herself and her later success. That Adelaide's decisions and motivations surrounding curriculum were consistently rooted in her goal to advance the role of women indicates that her priority always lay in promoting feminist values. As one of the first African-owned and run institutions, her school served as a gateway to advancing girls' education (Okonkwo, 1981, p.45).

Ultimately, Adelaide Casely Hayford's success in promoting her feminist and nationalist motivations must be attributed to her dynamic presence and respected status and Freetown's societal atmosphere. The Creoles' decaying relationship with the British community and their drawback from indulgence in the European lifestyle created an atmosphere in Freetown open to nationalist viewpoints. The nationalist movement's gaining traction and support in Freetown society created a setting that encouraged new approaches and ideas to African identity and life. Adelaide's own cultural pride aligned her heavily with the growing sentiments of the Creole elite community. Her connections and status in Freetown gave her the platform to voice her feminist ideas in conjunction with her nationalist values. 1900s Freetown was the perfect place and point in time for Adelaide to promote her ideologies, and Adelaide herself was the perfect person to listen to. Persuasive, inspiring, and passionate, Adelaide conveyed her message and her zeal for feminism and cultural pride so effectively that her benefactors and supporters continued to subsidize her endeavors despite her lack of financial gain. It was this combination of Sierra Leone society's political and social setting, along with Adelaide Hayford's determination, that allowed her to introduce and promote her feminist and nationalist agenda through the Girls' Vocational school.

### Works Cited

- Casely-Hayford, Adelaide, and Gladys Casely Hayford. *Mother and Daughter, Memoirs and Poems*. Edited by Lucilda Hunter, Sierra Leone University Press, 1983.
- Cromwell, Adelaide M. *An African Victorian Feminist: The Life and Times of Adelaide Smith Casely Hayford 1868-1960*. London, Frank Cass & Co. LTD., 1986.
- Denzer, LaRay. "Women in Freetown Politics, 1914-61: A Preliminary Study." *Africa: Journal of the International African Institute*, vol. 57, no. 4, 1987, pp. 439-56. *JSTOR*, <https://doi.org/10.2307/1159893>. Accessed 16 May 2024.
- Desai, Gaurav. "Gendered Self-Fashioning: Adelaide Casely Hayford's Black Atlantic." *Research in African Literatures*, vol. 35, no. 3, fall 2004, pp. 141-60. *JSTOR*, [www.jstor.org/stable/3821299](http://www.jstor.org/stable/3821299).
- Hair, P. E. H. "Africanism: The Freetown Contribution." *The Journal of Modern African Studies*, vol. 5, no. 4, 1967, pp. 521-39. *JSTOR*, [www.jstor.org.ezproxy.bpl.org/stable/158756](http://www.jstor.org.ezproxy.bpl.org/stable/158756). Accessed 1 May 2024.
- Kandeh, Jimmy D. "Politicization of Ethnic Identities in Sierra Leone." *African Studies Review*, vol. 35, no. 1, Apr. 1992, pp. 81-99. *JSTOR*, <https://doi.org/10.2307/524446>.
- Mikell, Gwendolyn. "African Feminism: Toward a New Politics of Representation." *Feminist Studies*, vol. 21, no. 2, summer 1995. *JSTOR*, <https://doi-org.ezproxy.bpl.org/10.2307/3178274>.
- Okonkwo, Rina. "Adelaide Casely Hayford Cultural Nationalist and Feminist." *Phylon*, vol. 42, no. 1, 1981, pp. 41-51. *JSTOR*, <https://doi.org/10.2307/274883>.
- Okonkwo, Rina L. "Orishatukeh Faduma: A Man of Two Worlds." *The Journal of Negro History*, vol. 68, no. 1, winter 1983, pp. 24-36. *JSTOR*, <https://doi.org/10.2307/2717457>.
- Strickrodt, Silke. "AFRICAN GIRLS' SAMPLERS from MISSION SCHOOLS in SIERRA LEONE (1820s to 1840s)." *History in Africa*, vol. 37, 2010, pp. 189-245. *JSTOR*, [www.jstor.org.ezproxy.bpl.org/stable/40864625](http://www.jstor.org.ezproxy.bpl.org/stable/40864625). Accessed 10 May 2024.
- Wyse, Akintola J.G. *H.C. Bankole-Bright and Politics in Colonial Sierra Leone, 1919-1958*. Cambridge, Cambridge University Press, 1990. African Studies Series 64.

## Effect of Inactivation of MAPT Through Gene Knockdown on Tumor Invasion and Microtubule Stability in Prostate Cancer Cells by Luke Chen

### Abstract

The knockdown of microtubule associated protein tau (MAPT) within prostate cancer has already been found to increase the effectiveness of chemotherapies such as docetaxel (Yang et al). Tumor invasion is the amount in which a tumor can invade into surrounding tissue. High tumor invasion in cells can cause spreading in the cancer cells, leading to more difficult treatment, but can also lead to metastasis, the development of new tumors around the original tumor. Finding the tumor invasion is important to assess the amount of damage a tumor can cause, thus it is important to test its significance in prostate cancer tumors in order to properly determine if it is viable to treat prostate cancer using shRNA to knockdown tau expression. This current data has shown a significant decrease in cell viability in the prostate cancer cells following the transfection of the shRNA supporting the original hypothesis. Currently, the research suggests that there is a statistically significant drop in viability when MAPT expression is decreased and there is not a significant change in tumor invasion, however, further research will be necessary to properly determine the relationship.

Keywords: Tau, MAPT, Tumor Invasion, Microtubule Stability, PC-3, Prostate Cancer, Androgen Independent

### Introduction

Current methods to treat prostate cancer are many times unable to permanently treat patients and many patients relapse after first-line treatment. Androgen independent prostate cancer is a common disease that affects about 1/3 of people with prostate cancer and has a life expectancy of 12 to 18 months compared to non androgen independent prostate cancer which has a 95% survival rate for 15 years (Chin, 2010).

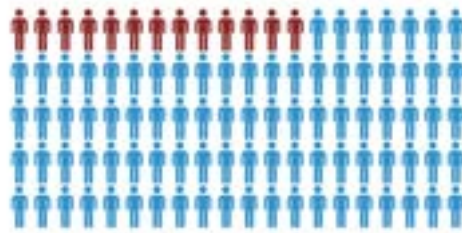

Image 1 above shows the 13 out of 100 American men who are affected by prostate cancer. (Division of Cancer Prevention and Control, 2021)

MAPT is a protein whose dysfunction is a root cause of many neurological diseases. More recently, tau has been researched within an increasing variety of non-neurological cancers. Tau normally binds to internal structures called microtubules, which control the nutrient flow in cells, allowing them to function properly. Under abnormal chemical changes, tau will not attach



to the microtubules and instead attach to each other, forming neurofibrillary tangles. Diseases with this pathological feature are called tauopathies. In diseases such as Alzheimer's, these tangles prevent the proper function of the microtubules and prevent the communication between neurons. Tau is present not only in neurons but also several other cell and tissue types. Within prostate cancer specifically, tau tangles have been shown to be phosphorylated, with sharing many of the characteristics with tau found within Alzheimer's (Souter & Lee, 2009). A large amount of the tau proteins do not bind to microtubules in previous studies on prostate cancer cells. While an increase of tau has been found in the past, by Nakata et al. (2020), to increase cell invasion in assays designed to mimic tumor invasion, there has also been research by Yang et al. (2017) which found that a reduction in tau expression in prostate cancer would decrease cell proliferation, which may suggest that tumor invasion would be reduced if tau expression were to be lowered in prostate cancer cells. In this experiment, PC-3 cells will have a knockdown in tau expression, through shRNA, in order to test for tumor invasion and cell viability. Tumor invasion, or how much the tumor is capable of penetrating into nearby tissues and infecting them is a major factor in how much damage a cancer is able to cause. By testing the prostate cancer cell's tumor invasion after the inactivation of tau through gene knockdown, the possibility of using a reduction tau expression to treat prostate cancer can be determined as well. PC-3, the cell line of prostate cancer adenocarcinoma that will be used in this experiment, has been found to naturally express moderate amounts of tau.

As a protein, tau is not well understood, it is not completely clear how tau promotes brain cell damage and death within Alzheimer's (Alzheimer's Association, 2021). It is thought that this is caused by the disturbance in microtubule function in cells by highly phosphorylated tau. Because of this, it is important to find the effects that tau has on different diseases and cell types in order to further understand the protein's functions. Other recent research has found that in vitro, inactivation of tau through gene knockdown has suppressed cell proliferation and sensitized docetaxel cytotoxicity (Yang et al., 2017). It was proposed that the tau within prostate cancer cells was competing with the drugs for microtubule binding sites, overall lowering the effectiveness of the drug. Resistance to docetaxel, and other chemotherapy drugs, is a significant problem in the treatment of prostate cancer, so it is essential that strategies to reduce tau expression are developed. It is possible that tau reduction can be a solution for this resistance to chemotherapies. In this experiment, the feasibility of using gene knockdown to treat tau expression is determined by testing its effect on invasion. It will also test previous results that supported tau expression reduced cell viability. This experiment is important because developing a treatment for prostate cancer is necessary as it is a common disease that affects about 13 out of every 100 American men (Division of Cancer Prevention and Control, 2021). Many current cures such as chemotherapies are not permanent and many patients relapse after first-line treatment. Tumor invasion, which is the amount cancer cells can penetrate into surrounding tissue, is an essential factor in the dangers of cancer because it is directly related to the damage which the tumor can cause as well as how much it will spread. The ShRNA, or short hair RNA strands, that will be used to silence the tau expression have been used in a previous experiment

by Yang et al. (2017) to knockdown tau expression. Their strands shTau-1, shTau-2, and shTau-3 all reduce tau expression lower than the naturally produced amount. Short hair RNA is used because the required strand has already been found and can be effectively produced using the T100 Thermal Cycler.

Currently, research is being done on countermeasures to docetaxel resistance (Yang et al., 2017). Docetaxel is a chemotherapy drug frequently used in treatments of major types of cancers such as lung and breast carcinoma. Yan et al. (2017) supported that the reduction of tau protein in prostate cancer increased resistance of docetaxel in prostate cancer, but however, need more evidence of such a relation. However, tau oligomers have been shown to sensitize prostate cancer cells to docetaxel treatment (Martellucci et al., 2021). In fact, they found that overexpression of tau within cancer helps stabilize the DNA in the cancer cells. They had cited the previous article, stating that the reason for the lowering of cell proliferation was likely due to autophagy. If this were to be true, it would support that tau could increase the tumor growth and invasion, as autophagy has been previously found to inhibit cancer cell survival but also facilitate tumorigenesis by promoting cancer-cell proliferation and tumor growth (Yun & Lee, 2018). This challenges the possibility of reducing tau expression in prostate cancer cells as a treatment method. It is important that the effects of tau in prostate cancer are clearly understood before the possibility of knockdown of tau to treat prostate cancer is considered. Furthermore, it has been found that Alzheimers has an inverse relationship with cancer (Driver, 2012). In the study, it was found that cancer survivors had less of a chance to get Alzheimers while patients with Alzheimer's have a lower risk of cancer. This supports that higher tau, as Alzheimer's is associated with high amounts of tau, could prevent the incidence of cancer. According to Souter and Lee (2009), tau within prostate cancer does not completely work in the same way as that within a healthy human brain, which supports that tau may be a multifunctional protein. They confirmed that within prostate cancer, tau is in a highly phosphorylated state and that there are high levels of tau expression within the prostate cell lines ALVA-31, DU 145, and PC-3. Specifically, the phosphorylation of tau within prostate cancer resembled that of neurological disease rather than that of an adult brain. Phospho-Ser396, found within Alzheimer's disease brain and several other age-related neurodegenerative diseases, is an early marker of Alzheimer's Disease brain is upregulated during mitosis, so it stated that it is not very surprising that cancer cells that have high levels of mitosis would contain tau that resembles that of neurological diseases. Higher levels of tau mRNA expression have also been shown to decrease tumor invasion in assays designed to simulate tumor invasion (Nakata et al., 2020). Other neurological diseases such as Parkinsons recently found to also share these traits (Zhang et al., 2018). They have also been shown to increase patient survival. It was also shown that frontotemporal dementia mutations impair and diminish tau's interactions with mitochondrial proteins, shedding light on tau's role in neuronal function (Tracy et al., 2021). Higher levels of tau have been shown to decrease tumor invasion, so it is important to test the effect of inactivation of tau expression on prostate cancer and to determine its viability as a treatment. Tau has had a varied effect on

many different types of diseases and further study is needed in order to further determine its functions.

In the research, the cells will be transfected with the shRNA using a lipofectamine system and the target sequence will be shTau-1, shTau-2, and shTau-3. After the tau knockdown, I will evaluate the tau expression through western blot to determine the effectiveness of the tau knockdown. For the variables, cell invasion using will be measured with a transwell invasion assay, and the cell proliferation and viability through will be measured through Acid Phosphatase assays. In this project, the independent variable is the type of shRNA used to reduce the tau expression. The dependent variable is the tumor invasion, cell viability, and cell proliferation of the cell line after it has been transfected with the shRNA. The control group will be the cell line that does not have a reduction in tau expression. While past research has been done on effects of tau on cell proliferation and drug resistance in prostate cancer, there have been no past studies on the effects of tau on tumor invasion in prostate cancer cells, which is an important aspect determining the safety of using reducing tau expression. I will be using PC-3 cells, which are prostatic adenocarcinoma, and also test a past study that showed that cell viability would be decreased after a knockdown of tau expression. I hypothesize that the knockdown of tau will cause lower levels of tumor invasion in the PC-3 cells that I will be working with. I believe this because while increased levels of tau have been shown to decrease tumor invasion, a lower proliferation of prostate cancer cell lines caused by reduced tumor invasion should also lead to a reduction in cell invasion. In the case that my hypothesis is disproven, further research would need to be done to test the possibility of reducing tau expression as a treatment method for prostate cancer and more insights into how cell invasion is affected by tau should be done. In this research, I hope to provide further insight into how tau affects cancer and determine the viability of treating prostate cancer through gene knockdown reduced tau expression. Current methods to treat prostate cancer are many times unable to permanently treat patients and many relapse after first-line treatment. I believe that reducing tau expression can benefit those with prostate cancer and help increase the effectiveness of treatment via chemotherapy.

### **Methodology Overview**

In the research, the cell invasion of the PC-3 cells (purchased from Sigma Alrich) was measured using a transwell cell invasion assay. The cell invasion of each of the transfected cell lines will be compared to the control cell lines in order to determine the statistical difference in cell invasion. Cell viability and growth will be measured in a similar process using the acid phosphatase assay.

There will be as many trials as possible for each of the experiments, each with 5 groups, 2 controls and 1 cell line transfected with shTau. The negative control will be the PC-3 cells without any transfection of shRNA. This is in order to produce a baseline of the amount of invasion a normal PC-3 cell has. For the positive control, Invitrogen™ BLOCK-iT™ Alexa Fluor™ Red Fluorescent Control will also be transfected into cells to compare to cells transfected with the shRNA sequence. This is to ensure that the results of the transfection are due

to the RNA transplant and that the sequences were properly transfected into the cells. This also tests to see if the shRNA sequence transfection procedure is not having an unnatural effect on the data. For the assay control for cell invasion assay, in order to test if the assay is properly working, cells without the described chemoattractant solution will be tested in the transwell, and will have the RPMI1640 medium at the bottom in place of the chemoattractant. This will test to see if external factors are not causing the cell invasion.

This research is greatly limited by time, as many of the assays take time to do and there may not be enough time in the year to perform them. There may not be enough time to perform the acid phosphatase assay and test the cell viability, so it is possible that the cell viability won't be tested in this experiment. Certain drugs such as docetaxel can't be tested as they are prescription drugs which can't be purchased by the Academies of Loudoun. Certain materials, such as the microtubule polymerization kit were too expensive to purchase so were delayed and could possibly be tested in future research. Invitrogen™ BLOCK-iT™ Alexa Fluor™ Red Fluorescent Control wasn't used within the acid phosphatase assays as it wasn't purchased at the time of the assay. Also, following the acid phosphatase assay, the tumor invasion assay only used shTau-2 as it was found to be the most effective in decreasing tau expression in prior studies (Yang et. al 2017).

Each of the results will be used in a Kruskal Wallis nonparametric test as it is more accurate at lower amounts of data points than an t-test parametric test. The Kruskal Wallis test will be used to gain more accurate results from the data as parametric tests are less accurate at lower values and reduces the effects of outliers on the results. The Kruskal Wallis test uses medians, which allows for it to reduce the impact of outliers on the results in this research.

## **Results**

### Acid Phosphatase Assay for Viability

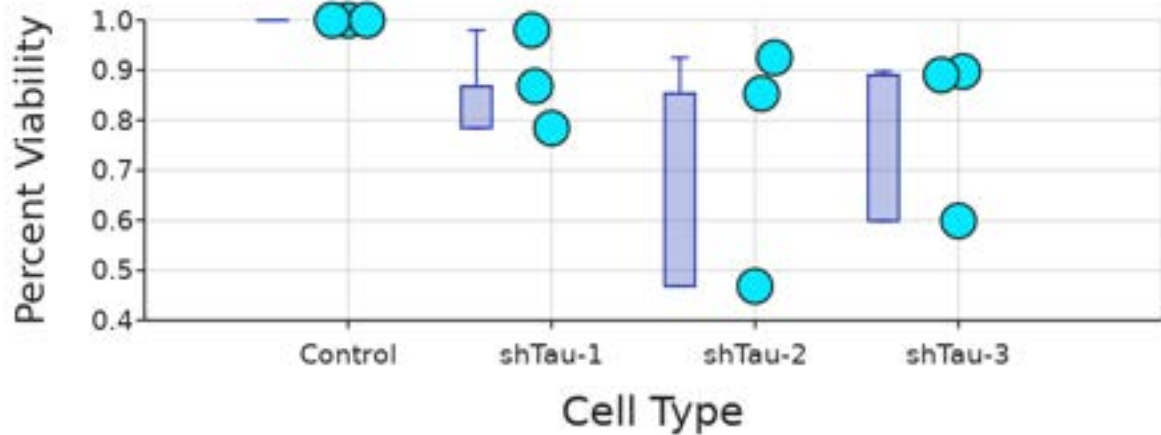

Note: Box and whiskers plot shows the median value (line), interquartile range (box), and the extent of the data (whiskers above and below at min / max data points).

Group	Mean	Std.dev	SEM	ci95lo	ci95hi	Median	Min	Max	q25	q75
Control	1	0	0	1	1	1	1	1	1	1
shTau-1	0.8774	0.09825	0.05673	0.6336	1.121	0.8681	0.7841	0.9795	0.7841	0.8681
shTau-2	0.749	0.246	0.142	0.139	1.36	0.853	0.468	0.925	0.468	0.853
shTau-3	0.7954	0.1704	0.09887	0.3728	1.218	0.8903	0.5987	0.8973	0.5987	0.8903

Image 2 shown above shows the Acid Phosphatase cell viability data showing the control cell and the original 3 types of shTau used types. The mean percent viability was taken of each column of cells and was compiled. The percent viability is done in proportion to the control so the control cell line of each was used as the baseline viability to be compared with, thus is always equal to 1.

As found by Yang et. al (2017), it seems based on the data that shTau-2 was the most effective of the treatments, having the largest effect on the cells based on the medians. According to Yang et. al (2017), shTau was found to have the greatest decrease in tau production. The Kruskal Wallis test found that there was a p value of 0.0188 which is less than the established critical value of .05. This suggests that there is a statistically significant difference between the control group and the experimental groups.

## Transwell Invasion Assay

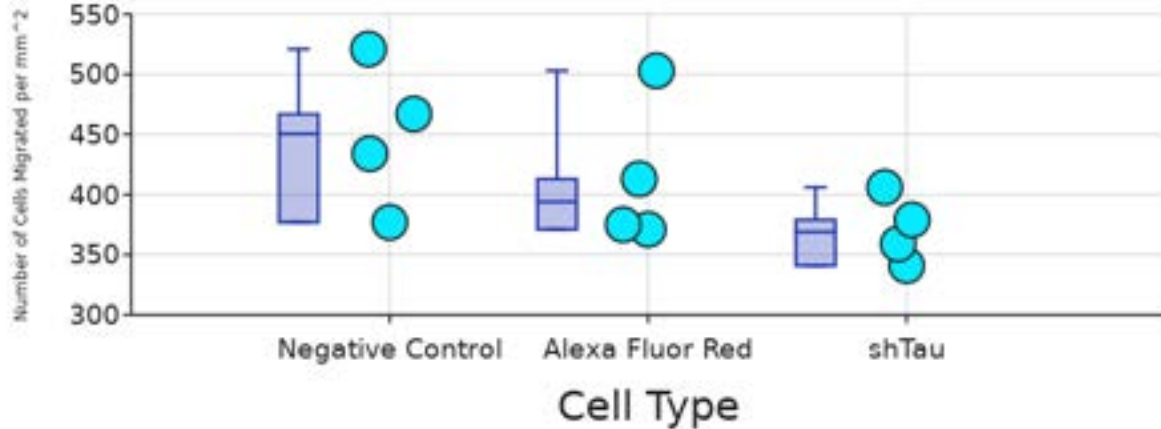

Note: Box and whiskers plot shows the median value (line), interquartile range (box), and the extent of the data (whiskers above and below at min / max data points).

Group	Mean	Std.dev	SEM	c95lo	c95hi	Median	Min	Max	q25	q75
Negative Control	449.8	60.32	30.16	354	545.5	450.5	377	521	377	467
Alexa Fluor Red	415.5	61.33	30.66	318.2	512.8	394	371	503	371	413
shTau	371.3	27.89	13.94	327	415.5	369	341	406	341	379

Image 3 shown above shows the Tumor invasion data from the transwell invasion assay showing three different cell types for 441.05 cells per mm<sup>2</sup> added to the well originally (read with the countess). It is likely that the cells grew in population after seeding so 441.05 cells per mm<sup>2</sup> is the original count of cells added to each well.

From the Kruskal-Wallis test performed on the acid phosphatase data, the p-value was found to be of the viability .00007. The result is significant as it is below the established critical value of  $p < .05$ . This supports the hypothesis that the control group and the cells that were transfected with shRNA had different medians in percent viability. Therefore, this research supports that viability will be lowered when PC-3 cells are transfected. The present data from the acid phosphatase assay shows a statistically significant decrease in viability when the cells are transfected compared to when they are not. The transwell invasion assay on the tumor invasion with a p value of .1462 suggests that there isn't a statistically significant change in tumor invasion caused by the decreased MAPT expression, however this could be due to large variability caused by the crystal violet deteriorating over time, leading to possible misrepresentation of the number of cells.

## Ethical Considerations

All experimentation was done in vitro on a PC-3 cell line, no live patients or organisms were used in this experiment.

## Discussion

From the Kruskal-Wallis test for the acid phosphatase assays, the p-value was found to be of the viability 0.0188. The result is significant as it is below the established critical value of  $p < .05$ . This supports the hypothesis that the control group and the cells that were transfected with shRNA had different medians in percent viability. Therefore, this research supports that viability will be lowered when PC-3 cells are transfected. This supports prior results found by Yang et. al (2017) The present data from the acid phosphatase assay shows a statistically significant decrease in viability when the cells are transfected compared to when they are not. The transwell invasion assay on the tumor invasion with a p value of .1462 suggests that there isn't a statistically significant change in tumor invasion caused by the decreased MAPT expression, however this could be due to large variability caused by the crystal violet deteriorating over time, leading to possible misrepresentation of the number of cells. There is also possible human error involved with counting the cells as it was difficult to determine which were cells at the time while counting. Also, biological differences can occur with the same cancer cell line so in the future, multiple prostate cancer cells lines should be tested to solidify the conclusions. In the future experiments, more transwell invasion assays should be run and a microtubule polymerization assay should be completed to determine causes of the potential change in tumor invasion.

The conclusions of this research could provide further knowledge on the safety of shTau transfection within live cell culture. Past research has found higher efficiencies of chemotherapies (such as docetaxel) in the presence of decreased tau expression (Yang et al., 2017). This suggests that shTau paired with these chemotherapies could serve as a possible treatment for androgen independent prostate cancer. Due to the high difficulty of treating androgen independent prostate cancer and the relatively short life expectancies, further leads into possible treatments should be considered. In the future experiments, more transwell invasion assays should be run and a microtubule polymerization assay should be completed to determine causes of the potential change in tumor invasion.

## **Methods**

The following are the methods used in this experiment

### **Cell Handling Procedures (ATCC, 2023)**

#### **Unpacking and storage instructions**

1. Check all containers for leakage or breakage. Remove the frozen cells from the dry ice packaging and immediately place the cells at a temperature below  $-130^{\circ}\text{C}$ , preferably in liquid nitrogen vapor, until ready for use.
2. Complete medium: The base medium for this cell line is RPMI1640 medium. To make the complete growth medium, add the following components to the base medium: fetal bovine serum to a final concentration of 10%.

#### **Safety (ATCC, 2023)**

- **All procedures must follow the subsequent safety protocols.**

- Wear lab coats, gloves and goggles to avoid dangerous exposure to chemicals or biological materials.
- For all biological materials BSL-2 and under, biosafety cabinets are used. When using the cabinet, spray the entire cabinet with ethanol, all things that are brought into the cabinet must be sprayed with ethanol, including hands. Entire cabinet should be sprayed after use.
- Closed toed shoes are worn to avoid tripping or cutting on broken glass.
- Long hair is tied up so as to not get tangled in lab equipment.

### **Biological Safety (ATCC, 2023)**

- Biosafety cabinets are used for any materials lower than BSL-2 or at BSL-2
  - Cells are not eaten or smelled, nothing is consumed around the chemicals.
- If in a liquid state, biological materials are disposed of after spraying with 10% bleach and left for 10 minutes to kill all the cells. The bottles are washed in the sink before being thrown away to prevent build-up of hazardous materials. If otherwise, put directly into the biomedical waste bag.
- All plastic containers are first autoclaved before being thrown out.
- When working on cells, wear lab coats and gloves so as to not contaminate the cells.
- All surfaces in the lab are sanitized with 70% before usage, so as to not contaminate the cells.
- Cells that become contaminated will be disposed of so as to not skew the results. They are bleached, cleaned in the sink, and disposed of into biohazard waste bags.

### **Chemical Safety**

- All hazardous material is put in the biohazard bin after use.

### **Cell Incubation Protocol (ATCC, 2023)**

To ensure the highest level of viability, thaw the vial and initiate the culture as soon as possible upon receipt. If upon arrival, continued storage of the frozen culture is necessary, it should be stored in liquid nitrogen vapor phase and not at  $-70^{\circ}\text{C}$ . Storage at  $-70^{\circ}\text{C}$  will result in loss of viability.

1. Thaw the vial by gentle agitation in a  $37^{\circ}\text{C}$  water bath. To reduce the possibility of contamination, keep the O-ring and cap out of the water. Thawing should be rapid (approximately 2 minutes).
2. Remove the vial from the water bath as soon as the contents are thawed, and decontaminate by dipping in or spraying with 70% ethanol. All of the operations from this point on should be carried out under strict aseptic conditions.
3. Transfer the vial contents to a 75 cm<sup>2</sup> tissue culture flask and dilute with the recommended complete culture medium (see the specific batch information for the recommended dilution ratio). It is important to avoid excessive alkalinity of the medium during recovery of the cells. It is suggested that, prior to the addition of the vial contents,



the culture vessel containing the growth medium be placed into the incubator for at least 15 minutes to allow the medium to reach its normal pH (7.0 to 7.6).

4. Incubate the culture at 37°C in a suitable incubator. A 5% CO<sub>2</sub> in air atmosphere is recommended if using the medium described on this product sheet.
5. If it is desired that the cryoprotective agent be removed immediately, or that a more concentrated cell suspension be obtained, centrifuge the cell suspension at approximately 125x g for 5 to 10 minutes. Discard the supernatant and resuspend the cells with fresh growth medium at the dilution ratio recommended in the specific batch information.

### **Cell Incubation Subculturing Procedure (ATCC, 2022)**

Volumes are given for a 75 cm<sup>2</sup> flask. Increase or decrease the amount of PC-3 Product Sheet CRL-1435 dissociation medium needed proportionally for culture vessels of other sizes.

Corning T-75 flasks (catalog #430641) are recommended for subculturing this product.

1. Remove and discard culture medium.
2. Briefly rinse the cell layer with 0.25% (w/v) Trypsin- 0.53 mM EDTA solution to remove all traces of serum that contains trypsin inhibitors.
3. Add 2.0 to 3.0 mL of Trypsin-EDTA solution to flask and observe cells under an inverted microscope until the cell layer is dispersed (usually within 5 to 15 minutes). Note: To avoid clumping do not agitate the cells by hitting or shaking the flask while waiting for the cells to detach. Cells that are difficult to detach may be placed at 37°C to facilitate dispersal.
4. Add 6.0 to 8.0 mL of complete growth medium and aspirate cells by gently pipetting.
5. Add appropriate aliquots of the cell suspension to new culture vessels.
6. Incubate cultures at 37°C.

### **Subcultivation Ratio**

A subcultivation ratio of 1:3 to 1:6 is recommended

### **Medium Renewal**

2 to 3 times per week

### **Reagents for cryopreservation**

Complete growth medium supplemented with 5% (v/v) DMSO (ATCC 4-X)

### **Lipofectamine 3000 Protocol/Transfection Protocol (Palchetti et. al, 2015)**

1. Seeded cells should be 70–90% confluent at transfection, around  $1-4 \times 10^4$  cells per well for 96 well plates and  $0.5-2 \times 10^5$  per well for 24-well plates.
2. Dilute Lipofectamine 3000 Reagent in serum free medium, Opti-MEM Reduced Serum

Medium (no fetal bovine serum, create 1 tube for each variable) adding about 3% of the media in Lipofectamine Reagent, so if 5 mL medium, there will be 0.15 mL reagent. This will create the P3000 Reagent– Mix well

3. Prepare a master mix of DNA by diluting DNA (shRNAs) in RPMI1640 medium, then add P3000 Reagent, the medium: DNA: reagent should have a 50 $\mu$ L : 1 $\mu$ g: 3 $\mu$ L ratio. - Mix well
4. Add Diluted DNA to each tube of diluted Opti-MEM Reduced Serum Medium (1:1 ratio) to create the plasmid DNA-lipid complex. Have enough for each well needed.
5. Incubate the DNA-lipid complex for 10-15 minutes at room temperature.
6. Add DNA-lipid complex to cells along with Invitrogen™ BLOCK-iT™ Alexa Fluor™ Red Fluorescent Control, 10  $\mu$ L per well for 96-well plates and 50  $\mu$ L per well for 24-well plates. 250  $\mu$ L per well for 6-well plates.
7. For the Block iT Alexa Fluor Red, Add 3  $\mu$ L siRNA (alexa fluor red) and 150  $\mu$ L of opti mem media Document Connect (thermofisher.com)
8. Have 150  $\mu$ L of opti meme and 9  $\mu$ L of Lipofectamine RNAiMAX reagent combined
9. Add both the diluted Alexa Fluor red and the lipofectamine reagent together and add 250  $\mu$ L to each well
10. Incubate cells for 2–4 days at 37°C, then visualize/analyze transfected cells in assays
11. Cover the Alexa Fluor Red container with tin foil as white light will get rid of the fluorescence, if the fluorescence needs to be measured.

#### **Seeding Well Plate** (Taken from Academy of Science Lab)

1. Using a 10mL pipette, take 4mL of the media with cells in them and expel 2mL of that media into a 15mL centrifuge tube
2. Add 8mL of complete growth medium to the microcentrifuge, make sure it is homogenized and the cells do not gather at the bottom when adding to the reservoir
3. Open the reservoir, try not to touch the inside of the reservoir and do not spray ethanol inside of it.
4. Take a 10mL pipette and homogenize the media, then take out 10 mL of solution and put it into the reservoir
5. Make sure the multi channel pipette is straight to avoid uneven volumes and fill up each of the wells with 200  $\mu$ L of the solution from the reservoir and incubate until proper confluency, around 1-3 days. For the 24-well plate add around 1000  $\mu$ L of solution per well.

#### **Acid Phosphatase Assay** (Taken from Academy of Science Lab)

1. Use a 96-well plate and transfected cells for this procedure.
2. Remove all media by inverting the plate on a bundle of paper towels
3. Fill each well with PBS by running pipette over plate
4. Remove PBS, but don't hit the cells out
5. Repeat steps 2 and 3, 2 more times, to wash off the cells.

6. To each well add 100  $\mu$ l of 10 mM p-Nitrophenyl phosphate disodium salt hexahydrate in 0.1 M sodium acetate pH 5.5 containing 0.1% Triton X-100
7. Weigh 0.8203 g of sodium acetate, put in a bottle. Add dH<sub>2</sub>O to 100 mL. Check pH (needs to be 5.5). Adjust with diluted HCl solution
8. Add 0.2 mL Triton X-100
9. Take 20 mL of the sodium acetate/Triton X-100 solution and dissolve 0.0526 g p-Nitrophenyl phosphate disodium salt hexahydrate in that
10. Replace lid. Place in the CO<sub>2</sub> incubator for two hours (Or overnight in a refrigerator wrapped in foil. Then, the next day, put in the CO<sub>2</sub> incubator for two hours)
11. After two hours, add 50  $\mu$ l of 1 M NaOH to each well and read on plate reader at 405 nm and 620 nm

### **Transwell Cell Invasion Assay** - from (Justus et al., 2014)

1. In a sterile environment (typically a biosafety cabinet) detach cells from the tissue culture plate using a non-enzymatic cell dissociation buffer or 0.25% Trypsin-EDTA solution, pellet cells by centrifugation, and aspirate the existing media leaving the pelleted cells. Re-suspend cells in serum free cell culture containing 0.1% BSA (bovine serum albumin). It is noted in the article that depending on the cell line used, the 0.25% Trypsin-EDTA solution may affect the migration and invasion because of the receptors on the cells. It is also noted that the number of cells per ml depends on the size of the cells. The seeding density of the cells may need to be adjusted for best results, a good starting density for the cells is  $1 \times 10^6$  cell/ml when using a 24-well transwell insert.
2. You need to thaw matrigel after taking it out of the freezer so it is viscous. Do Not just thaw matrigel, make sure to put it in ice?  
<https://certs-ecatalog.corning.com/life-sciences/product-descriptions/356234.pdf> is the sheet on how to use it  
<https://www.corning.com/catalog/cls/documents/application-notes/CLS-AN-209.pdf> for sizes of well plates
3. The transwell inserts are commercially available from companies such as Corning in sizes from 3  $\mu$ m, 5  $\mu$ m, and 8  $\mu$ m for cell migration assays, the 8  $\mu$ m will be used in this assay. These cell migration assays can also be turned into cell invasion assays by adding extracellular matrix (ECM) materials on top of the transwell membrane and then adding cells on top of the ECM. For example, cell solution can be added on top of Matrigel coating to simulate cell invasion through the extracellular matrix. The Matrigel layer is made by adding 50  $\mu$ l per cm<sup>2</sup> of Matrigel to a 24-well transwell insert and having it solidify in a 37 °C incubator for 15-30 minutes to form a thin gel layer (475  $\mu$ l for 6 well plates). Definitions: The transwell cell migration assay measures the chemotactic capability of cells toward a chemo-attractant (just the complete medium with 5% FBS). The transwell cell invasion assay, however, measures both cell chemotaxis and the

invasion of cells through the extracellular matrix, a process that is commonly found in cancer metastasis or embryonic development.

4. Plate 100  $\mu\text{l}$  of cell solution on top of the filter membrane in a transwell insert and incubate for 10 minutes at 37 °C and 5% CO<sub>2</sub> to allow the cells to settle down (300 $\mu\text{l}$  6-well plates). The article notes that the size of the pores in the transwell membrane may need to change depending on the cells; certain cells may not be able to fit through the smaller pore sizes.
5. Using a pipette, very carefully add 600  $\mu\text{l}$  of the desired chemo-attractant (complete medium with 5% FBS) into the bottom of the lower chamber in a 24-well plate (3mL for 6-well plate). Make sure to not move the transwell insert and avoid creating bubbles while doing this. Make sure the chemo-attractant liquid in the bottom well makes contact with the membrane in the upper well to form a chemotactic gradient. The number of migrated cells can be counted by using a hemocytometer or the countess. Tests may be needed to determine how long the incubation period should be.
6. Remove the transwell insert from the plate. Use a cotton-tipped applicator as many times as needed to carefully remove the media and remaining cells that have not migrated from the top of the membrane without damaging it.
7. Add 600-1,000  $\mu\text{l}$  of 70% ethanol into a well of a 24-well plate (3x for 6 well plate). Place the transwell insert into the 70% ethanol for 10 minutes to allow cell fixation. Remove transwell insert from the 24-well plate and use a cotton-tipped applicator to remove the remaining ethanol from the top of the membrane. Allow the transwell membrane to dry (typically 10-15 minutes).
8. Add 600-1,000  $\mu\text{l}$  of 0.2% crystal violet into a well of a 24-well plate and position the membrane into it for staining. Incubate at room temperature for 5-10 minutes.
9. Gently remove the crystal violet from the top of the membrane with a pipette tip or cotton-tipped applicator. Very carefully, to avoid washing off fixed cells, dip the membrane into distilled water as many times as needed to remove the excess crystal violet. Allow the transwell membrane to dry.
10. View underneath an inverted microscope and count the number of cells in different fields of view to get an average sum of cells that have migrated through the membrane toward the chemo-attractant and attached on the underside of the membrane.

#### **Cell Counting with Hemocytometer (For Invasion Assay). (vlab.amrita.edu, 2011)**

1. Pipette all but 0.5 mL into the centrifuge tube and then pipette the remaining 0.5 mL into a microcentrifuge tube.
2. Assemble the hemocytometer with the cover slip
3. Add 15-20  $\mu\text{l}$  of the contents of the microcentrifuge tube into the two counting chambers of the hemocytometer.
4. Place hemocytometer under an inverted microscope with 10x magnification.
5. Count the number of cells in each of the four square quadrants.

6. Then average the amount of cells and multiply by the dilution factor.

## Works Cited

- Alzheimer's Association. (2021). *Tau*. 800.272.3900.  
<https://www.alz.org/media/Documents/alzheimers-dementia-tau-ts.pdf>
- ATCC. (2023). PC-3 | ATCC. [Www.atcc.org. https://www.atcc.org/products/crl-1435](https://www.atcc.org/products/crl-1435)
- Chin, S N, Wang, L., Moore, M., Sridhar, S.S. (2010) “A review of the patterns of docetaxel use for hormone-resistant prostate cancer at the Princess Margaret Hospital.” *Current oncology (Toronto, Ont.)* vol. 17,2 (2010): 24-9. doi:10.3747/co.v17i2.482
- Division of Cancer Prevention and Control. (2021). *Who Is at Risk for Prostate Cancer?*. Centers for Disease Control and Prevention.  
[https://www.cdc.gov/cancer/prostate/basic\\_info/risk\\_factors.htm#:~:text=Out%20of%20e](https://www.cdc.gov/cancer/prostate/basic_info/risk_factors.htm#:~:text=Out%20of%20e)  
[very%20100%20American,chance%20of%20getting%20prostate%20cancer.](https://www.cdc.gov/cancer/prostate/basic_info/risk_factors.htm#:~:text=Out%20of%20e)
- Driver, J. A., Beiser, A., Au, R., Kreger, B. E., Splansky, G. L., Kurth, T., Kiel, D. P., Lu, K. P., Seshadri, S., & Wolf, P. A. (2012). Inverse association between cancer and Alzheimer's disease: results from the Framingham Heart Study. *BMJ (Clinical research ed.)*, 344, e1442 (2012). <https://doi.org/10.1136/bmj.e1442>
- Justus, C. R., Leffler, N., Ruiz-Echevarria, M., & Yang, L. V. (2014). In vitro cell migration and invasion assays. *Journal of visualized experiments: JoVE*, (88), 51046 (2014).  
<https://doi.org/10.3791/51046>
- Palchetti, S., Starace, D., De Cesaris, P., Filippini, A., Ziparo, E., & Riccioli, A. (2015). Transfected poly(I:C) activates different dsRNA receptors, leading to apoptosis or immunoadjuvant response in androgen-independent prostate cancer cells. *The Journal of biological chemistry*, 290(9), 5470–5483 (2015).  
<https://doi.org/10.1074/jbc.M114.601625>
- Martellucci, Stefano, Clementi, L., Sabetta, S., Muzi, P., Mattei, V., Bologna M., Angelucci, A. “Tau oligomers accumulation sensitizes prostate cancer cells to docetaxel treatment.” *Journal of cancer research and clinical oncology*, vol. 147,7 (2021): 1957-1971.  
doi:10.1007/s00432-021-03598-3
- National Institute on Aging. (2017). *What Happens to the Brain in Alzheimer's Disease?*. National Institutes of Health.  
<https://www.nia.nih.gov/health/what-happens-brain-alzheimers-disease>
- Nakata, S., Price, A., Eberhart, C., & Morris, M., (2020). Increased Tau Expression Correlates With IDH Mutation in Infiltrating Gliomas and Impairs Cell Migration, *Journal of Neuropathology & Experimental Neurology*, Volume 79, Issue 5, May 2020, Pages 493–499 (2020), <https://doi.org/10.1093/jnen/nlaa013>
- Souter, S., & Lee, G. (2009). Microtubule-associated protein tau in human prostate cancer cells: isoforms, phosphorylation, and interactions. *Journal of cellular biochemistry*, 108(3), 555–564 (2009). <https://doi.org/10.1002/jcb.22287>
- Tracy, T. E., Madero-Pérez, J., Swaney, D. L., Chang, T. S., Moritz M., Konrad, C., Ward, M. E., Stevenson, E., Hüttenhain, R., Kauwe, G., Mercedes, M., Sweetland-Martin, L., Chen, X., Mok, S., Wong, M. Y., Telpoukhovskaia, M., Min, S., Wang, C., Sohn, P. D., Martin,

- J., Zhou, Y., Luo, W., Trojanowski, J. Q., Lee, V. M.Y., Gong, S., Manfredi, G., Coppola, G., Krogan, N. J., Geschwind, D. H. & Gan, L. (2021). Tau interactome maps synaptic and mitochondrial processes associated with neurodegeneration. *Cell*, Volume 185, Issue 4, 2022, Pages 712-728.e14, ISSN 0092-8674 (2021), <https://doi.org/10.1016/j.cell.2021.12.041>.
- vlab.amrita.edu. (2011). Hemocytometer (Counting of Cells) (Procedure) : Cell biology Virtual Lab II : Biotechnology and Biomedical Engineering : Amrita Vishwa Vidyapeetham Virtual Lab. Amrita.edu. <https://vlab.amrita.edu/?sub=3&brch=188&sim=336&cnt=2>
- Yang, J., Yu, Y., Liu, W., Li, Z., Wei, Z., & Jiang, R. (2017). Microtubule-associated protein tau is associated with the resistance to docetaxel in prostate cancer cell lines. *Research and reports in urology*, 9, 71–77 (2017). <https://doi.org/10.2147/RRU.S118966>
- Yun, C. W., & Lee, S. H. (2018). The Roles of Autophagy in Cancer. *International journal of molecular sciences*, 19(11), 3466 (2018). <https://doi.org/10.3390/ijms19113466>
- Zhang, X., Gao, F., Wang, D., Li, C., Fu, Y., He, W., & Zhang, J. (2018). Tau Pathology in Parkinson's Disease. *Frontiers in neurology*, 9, 809 (2018).

## Supervised Machine Learning for Tweet Sentiment Analysis By Yuvika Verma

### Abstract

Tweets are a large volume of data available in unstructured format that contains opinions and emotions. These types of data in social media platforms are detected for the opinions using sentiment analysis. Three types of polarity classes are included in sentiment analysis such as negative, positive and neutral. Finer results are observed by tracking the users where the tweets are uplifted or down-lifted according to the user content. Supervised Machine learning algorithms like Naïve Bayes algorithm, Support vector machine and regression analysis are used for tweet sentiment analysis. Sentiment analysis is used for understanding feedback of the customers, opinions, emotions, politics, marketing, brand reputation and crisis management. The classification performance of machine learning techniques is analysed based on various performance metrics for tweets. The research framework of the study includes the collection of tweets sentiment analysis and then classification of Twitter text using supervised machine learning techniques. The tweets are considered as the user reviews posted using hashtag forms for expressing their opinions and emotions.

**Keywords:** Sentiment analysis, supervised machine learning, Naïve Bayes, Regression, Support Vector machine

### Introduction

A vast number of people have been interested in social networking sites such as Facebook, Instagram, and Twitter in recent years. People use social media as a platform to express their feelings, thoughts as well as opinions on various items, locations, or people. The three main categories of sentiment analysis techniques are hybrid, machine learning, and lexicon-based (Medhat, Hassan & Korashy). Comparably, the categories of knowledge-based, statistical, and hybrid techniques have been proposed in another classification. There is room for difficult study in many domains using sentiment and opinion analysis through computing (Anjaria & Guddeti). Several studies have focused on Twitter because it is a well-known microblog and has made predictions about consumer brands, democratic election outcomes, box office receipts, celebrity popularity, the stock market, etc. Sentiment analysis on a social network based on Twitter provides a quick and effective means of keeping an eye on public opinion. The use of machine learning techniques for the purpose of emotion prediction on Twitter, taking into account features unique to Twitter, like retweets. Additionally, we focus on identifying terms that are both immediate and extended in relation to the event in order to comprehend its impact. As a result, the practice of gradually extracting information from social network data for the goals of election prediction, education, business, communication, and marketing has emerged. Social network-based behavioral analysis can be used to determine the precision of sentiment analysis and forecasts (Hasan, Moin, Karim & Shamshirband).

Sentiment analysis and opinion mining have grown quickly, with the goal of using machine learning techniques with calculating polarity, analysing the subjectivity and sentiment



analysis for the text and opinions available in the text format from the sites of social media. During election time, several machine learning approaches and tools are used for sentiment analysis. The work contribution includes the implementation of a hybrid strategy that incorporates sentiment analyser with machine learning techniques for understanding the opinion and emotions. Moreover, the work compares various methods of sentiment analysis using supervised machine learning techniques for analyzing political opinions like support vector machines and Naïve Bayes (Ghiassi & Lee).

Twitter's messaging service has evolved into a forum for users to voice opinions and absorb news. Researchers have had difficulty accurately collecting these feelings. Dictionary-based and supervised machine learning techniques are used in the conventional methods of Twitter sentiment analysis to classify sentiment. This study employs supervised machine learning methodology. The choice of features, which is frequently domain-specific, is a significant obstacle for the machine learning technique. We tackle this particular issue and offer a fresh method to find a vocabulary set exclusive to TSA. It is demonstrated by us that the Twitter Specific Lexicon Set is both tiny and, crucially, domain portable. A collection of vectorized tweets is produced during this identification process and can be fed into machine learning software. Using conventional methods, this vectorization frequently yields an extremely sparse input (Alamoodi, Zaidan, Albahri, Mohammed, Malik & Alaa).

## **Literature Review**

Social media sites like Twitter give users a place to connect, discuss, and contribute to certain topics by allowing them to publish their opinions and views in the form of 140-character tweets. Users can engage with each other by utilizing likes, comments, and repost buttons, and this can be done through texts, images, videos, and more. As per Twitter, the number of recorded accounts that the network can identify and display advertisements on has exceeded 206 million daily active users in 2022. As more individuals utilize social media, study of publicly available data can be used to consider how people's psychology, behavior, and views have changed (Yadav, Kudale, Rao, Gupta, & Shitole).

Sentiment analysis is a technique used to gather viewpoints, attitudes, and feelings from social media platforms like Twitter. It is now an accepted field of study. Textual data is the main focus of sentiment analysis done the traditional way. The most well-known microblogging social networking site is Twitter, where users send updates in the form of tweets about various subjects. They used a labelled dataset that is publicly accessible on Kaggle. It also structures a thorough pre-processing workflow that gradually reduces the tweets' difficulty to handle using standard language handling techniques. Given that every dataset example consists of two tweets and a sentiment. Thus, machine learning that is supervised is applied. Furthermore, models are proposed for sentiment analysis based on support vector machines, logistic regression, and naive Bayes (Susmitha, Nikhil, Akhil, Kavitha, Reddy & Shailaja).

Sentimental analytics is a phenomenon that displays the thoughts, feelings, and views of many individuals. It also goes by the name "opinion meaning," which denotes the text's

emotional undertone. The Mechanism indicates if the outcome is neutral, negative, or positive. It provides more precise results, allows for user tracking, and indicates whether the user's content has elevated or deflated the tweet. To produce an exact result, machine learning can be studied utilizing a variety of analytical techniques. Data analysis is one of the sectors where machine learning methods are widely used. In this work, the Twitter analysis is predicted by the application of machine learning algorithms. The solution makes use of machine learning (ML) algorithms as the Support vector machine, Logistic regression and Naïve Bayes algorithm. The accuracy, F1 score, recall and precision of the implemented algorithm are examined in relation to the tweets that were extracted from social media (Qi & Shabrina).

The study gathers information about Covid-19 information from Twitter users in the major cities of England and divides it into three phases. First, we clean the data, and then we classify the tweets' sentiment orientations at each stage using unsupervised lexicon-based methods. Next, we employ supervised machine learning techniques by training the Random Forest classifier, Multinomial Naïve Bayes classifier, and SVC, respectively, using a sample of annotated data. The three phases of shifts in public opinion on the COVID-19 pandemic can be identified using lexicon-based methods. In the majority of cities, the percentage of positive sentiments rises and subsequently falls, whereas the percentage of negative sentiments changes in a different way (Reddy, Vasundhara, & Subhash). Most of the literature studies discuss sentiment analysis using one or two machine learning techniques.

## **Methodology**

### **Research Objective**

The objectives of the research study are

- ❖ To analyse tweets using sentiment analysis for detecting emotions and opinions
- ❖ To analyse tweets using supervised machine learning techniques like Naïve Bayes, Supervised machine learning and regression analysis

The research framework of the study includes the collection of tweets sentiment analysis and then classification of Twitter text using supervised machine learning techniques. The tweets are considered as the user reviews posted using hashtag forms for expressing their opinions about the topics that are in trends that may be political, finance, economy, education, medicine, drugs and vaccines, researches and recent discoveries. Then, we applied Naïve Bayes, SVM Classifier and Regression classifier on the training set for building the classification model. The models were tested for obtaining accuracy and other parameters for each classifier on training data set.

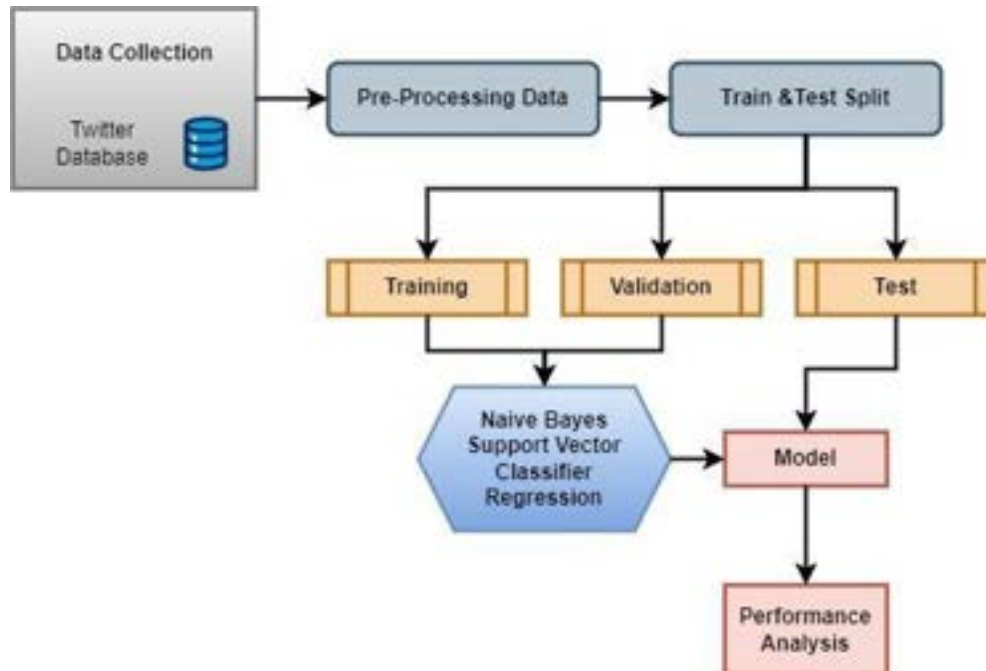

Figure 1: Proposed Methodology

The proposed methodology is given in figure 3.1. It includes data collection, data pre-processing. After preprocessing the data is split into training and testing. The trained set is validated using Naïve Bayes, Regression and SVM classifier for performance analysis using Python.

## Dataset

We have collected a quality dataset with sufficient number text documents. Additionally, open-source datasets such as FacebookAI, GoogleAI and Kaggle are used in the research study. We used publicly accessible Twitter datasets including fake and real text documents <https://github.com/KaiDMML/FakeNewsNet>. The retrieved tweets are collected as data sets from the database are used in the research study. The other language tweets are also translated into English and then the data set was pre-processed. The number of tweets taken for the research study is 3000 tweets. Website data are susceptible to various flaws, noise, unprocessed format, and other factors. Flickr is used for gathering texts and automatically scaled and aligned dlib for avoiding website biases. Only Twitter Ids with permissive licenses were chosen. 1500 genuine and 1500 fake text documents were selected from the Twitter database.

## Preprocessing

Preprocessing data is necessary for data analysis applications in order to eliminate unnecessary information and speed up the learning process of classification models for higher accuracy. Any data that adds very little or no value to the prediction of the target class is considered superfluous information; yet, it enlarges the feature vector and adds needless computational complexity. Consequently, if preprocessing is done incorrectly or not at all, the

performance of classification models suffers. Therefore, pretreatment or data cleaning is done before encoding (Jivani, 2011). The NLP toolkit for Python was utilized in this study to preprocess the twitter data. The texts are first converted into lower case and then any links, HTML, punctuation and tags are eliminated. After that, the text is cleaned up using lemmatization and stemming techniques, and stop words are finally eliminated.

- Convert to lowercase: Converting the text to lowercase reduces the complexity of the feature set as, 'go' and 'Go' are taken as different features by machine learning models, so converting to lowercase both terms will be 'go'. Models consider upper- and lower-case words as different words which affect the training process and classification performance.
- URL links, tags, punctuation, and number removal: URL links, tags, punctuation, and numbers do not contribute to improving the classification performance because they provide no additional meaning for learning models and increase the complexity of feature space, so removing them helps to reduce the feature space.
- Stemming and Lemmatization: The goal of both stemming and lemmatization is to reduce inflectional forms and sometimes derivationally related forms of a word to a common base form (Twitter Apps. Available online: <http://www.tweepy.org/>, accessed on 26 February 2018). For example, 'walks', 'walking', and 'walked' are converted to the root word 'walk' in this process.
- Stop words removal: Stop words are frequently used words that give no useful information for analysis. Stop words such as 'the', 'is', 'a', and 'an' are

### **Sentiment Analysis**

A large volume of data is available in unstructured format that contains opinions and emotions of the twitter users. These types of data in social media platforms are detected for the opinions using sentiment analysis. Three types of polarity classes are included in sentiment analysis such as negative, positive and neutral. Each tweet is given a score between -1 and 1, depending on the words used. Negative sentiment is indicated by negative score, positive sentiment is indicated by positive score, and neutral sentiment is indicated as zero score. This method determines the polarity of each tweet. Each tweet is given a subjectivity score that is determined by whether it represents an objective or subjective meaning.

### **Naïve Bayes Classifier**

Step 1 – Data files with tweets are created for classification as training and testing set for sentiment analyser

Step 2 – Csv files are converted for Weka compatibility

Step 3 – Naïve Bayes model is built on Weka

Step 4 – After application of StringToWordVector. The model is executed on the test set and results are saved as Output.

	Precision	Recall	F1-Score	Accuracy
<b>0</b>	0.92	0.20	0.34	
<b>1</b>	0.78	0.99	0.88	
<b>Mac. Average</b>	0.85	0.60	0.61	
<b>Wgt. Average</b>	0.82	0.79	0.74	0.79

### SVM Classifier

Step 1 – Data files with tweets are created for classification as training and testing set for sentiment analyser

Step 2 – Csv files are converted for Weka compatibility

Step 3 – Naïve Bayes model is built on Weka

Step 4 – 70% split approach is applied

Step 5 – After application of StringToWordVector. The model is executed on the test set and results are saved as Output.

### Results and discussion

This results section provides the experimental details of the research study and discussion supporting the research study. The aim of determining accuracy, precision, recall, F1-score for the tweets using different types of sentiment analysis.

Table 1: Parameters of Naïve Bayes Classifier

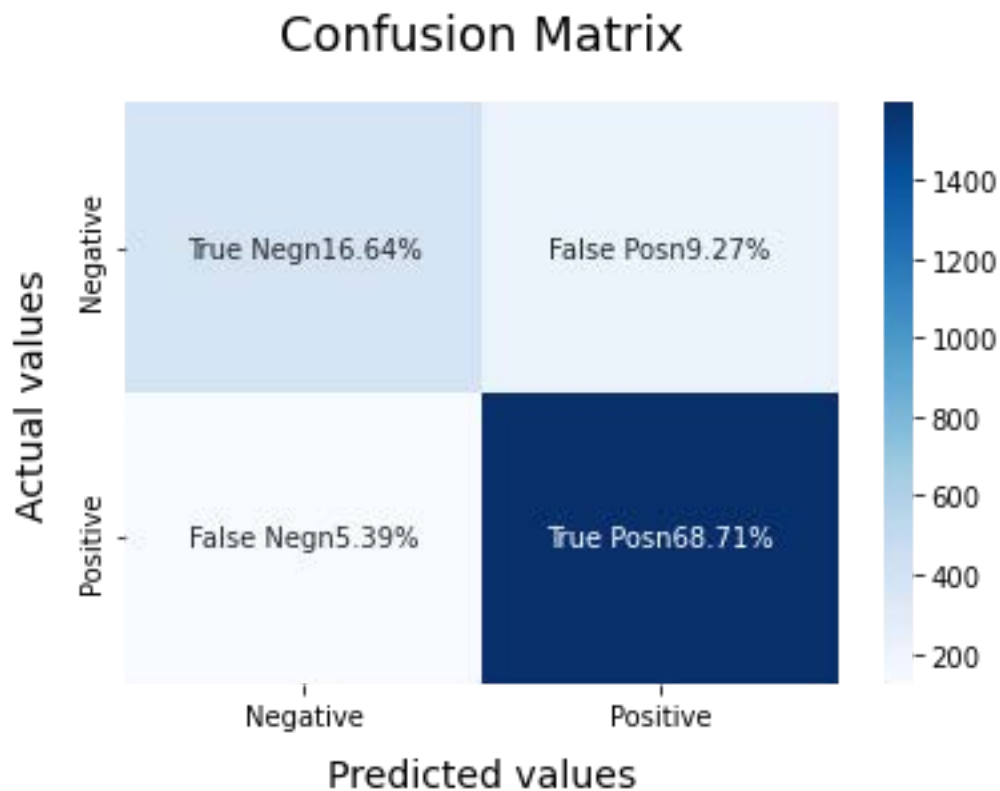
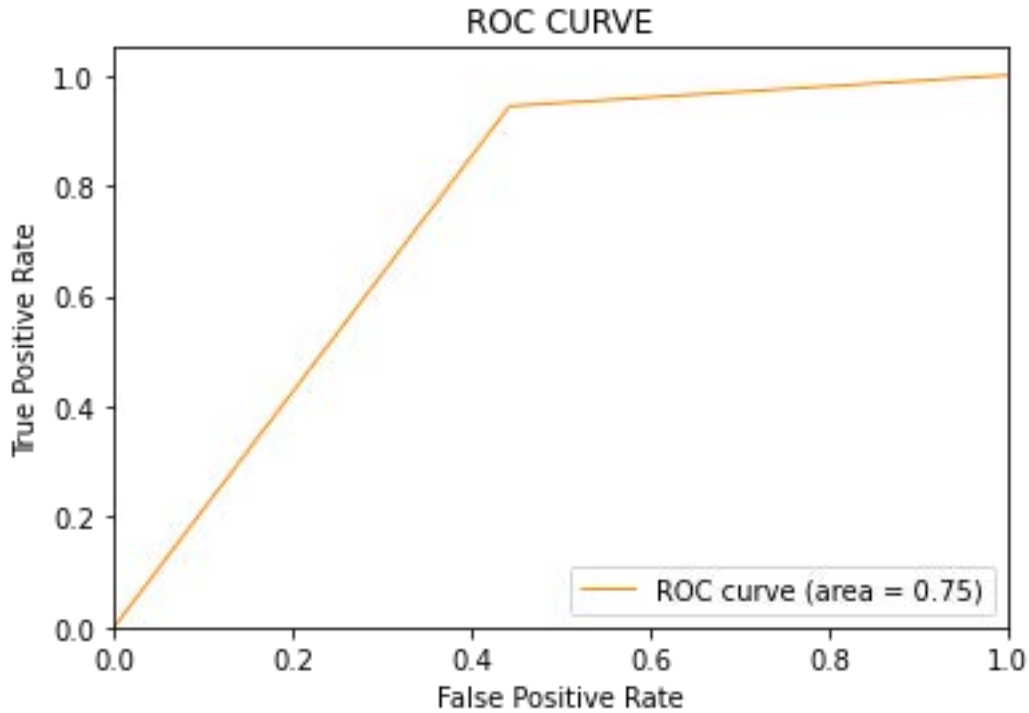

Figure 2: Confusion matrix of Naïve Bayes Classifier for tweet sentiment analysis  
 The classification models are evaluated using a confusion matrix for analysing the performance of the models. The matrix consisted of true positive, false positive, true negative and false negative. The performance metrics of Naïve Bayes Classifier are calculated such as precision, recall, F1 score and accuracy is 0.82, 0.79, 0.74 and 0.79.



**Figure 3:** ROC curve of Naïve Bayes Classifier for tweet sentiment analysis  
 The above figure 4.2 shows the graph that represents various thresholds and the trade-off between false positive rate against true rate. It shows the performance of the classification model. Our model achieved AUC of 0.75.

Table 2: Parameters of Support Vector Classifier

	<b>Precision</b>	<b>Recall</b>	<b>F1-Score</b>	<b>Accuracy</b>
<b>0</b>	0.76	0.64	0.69	
<b>1</b>	0.88	0.93	0.90	0.85
<b>Mac. Average</b>	0.82	0.78	0.80	
<b>Wgt. Average</b>	0.85	0.85	0.85	

The classification models are evaluated using a confusion matrix for analysing the performance of the models. The matrix comprises true positive, false positive, true negative and false negative. The performance metrics of SVM Classifier are calculated such as precision, recall, F1 score and accuracy is 0.85, 0.85, 0.85 and 0.85.

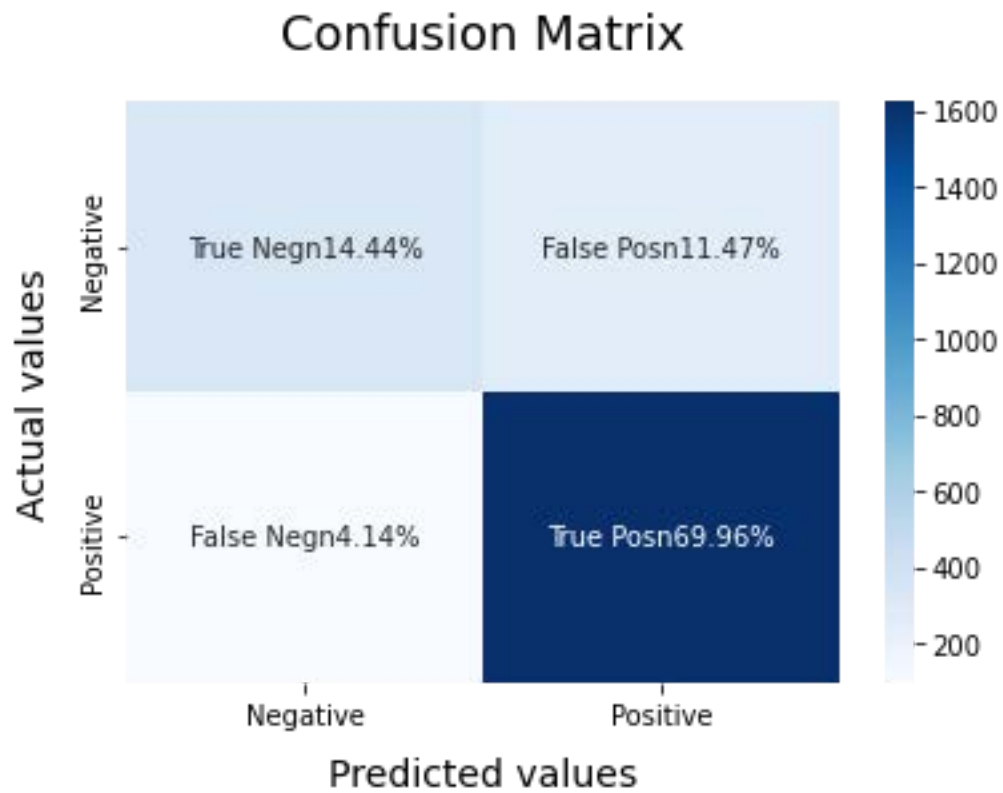

Figure 4: Confusion matrix of Support Vector Classifier for tweet sentiment analysis

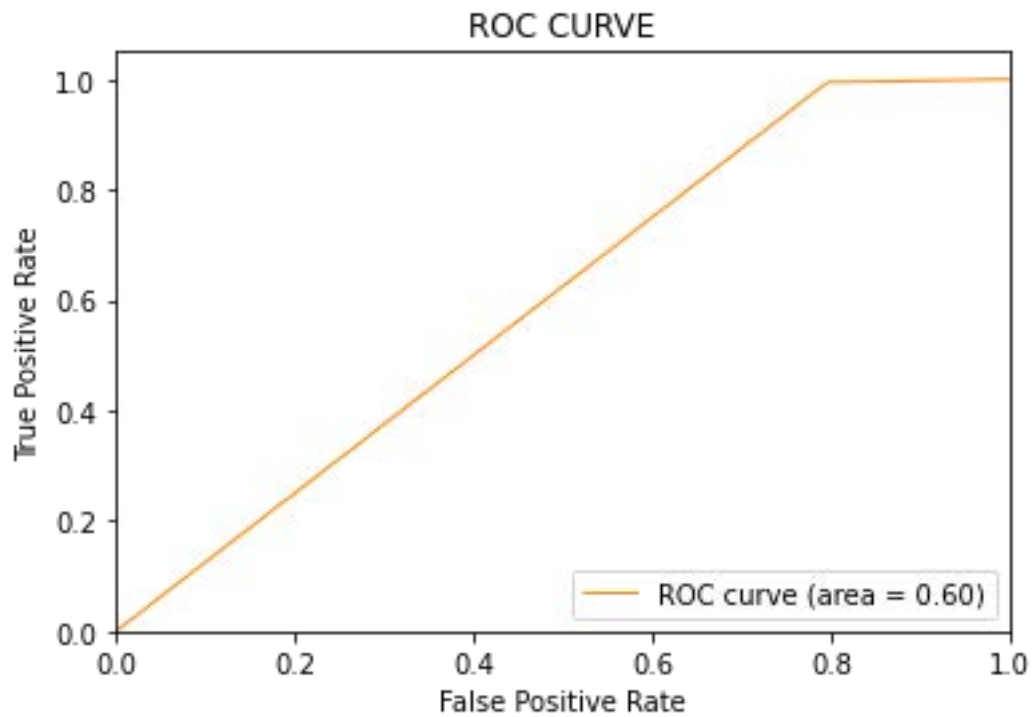

Figure 5: ROC curve of Support Vector Classifier for tweet sentiment analysis  
 The above figure 4.2 shows the graph that represents various thresholds and the trade-off between false positive rate against true rate. It shows the performance of the classification model. Our model achieved AUC of 0.60.

Table 3: Parameters of Regression Classifier

	<b>Precision</b>	<b>Recall</b>	<b>F1-Score</b>	<b>Accuracy</b>
<b>0</b>	0.78	0.56	0.65	
<b>1</b>	0.86	0.94	0.90	0.84
<b>Mac. Average</b>	0.82	0.75	0.77	
<b>Wgt. Average</b>	0.84	0.84	0.83	

The classification models are evaluated using a confusion matrix for analysing the performance of the models. The matrix comprises true positive, false positive, true negative and false negative. The performance metrics of Regression Classifier are calculated such as precision, recall, F1 score and accuracy is 0.84, 0.84, 0.83 and 0.84.

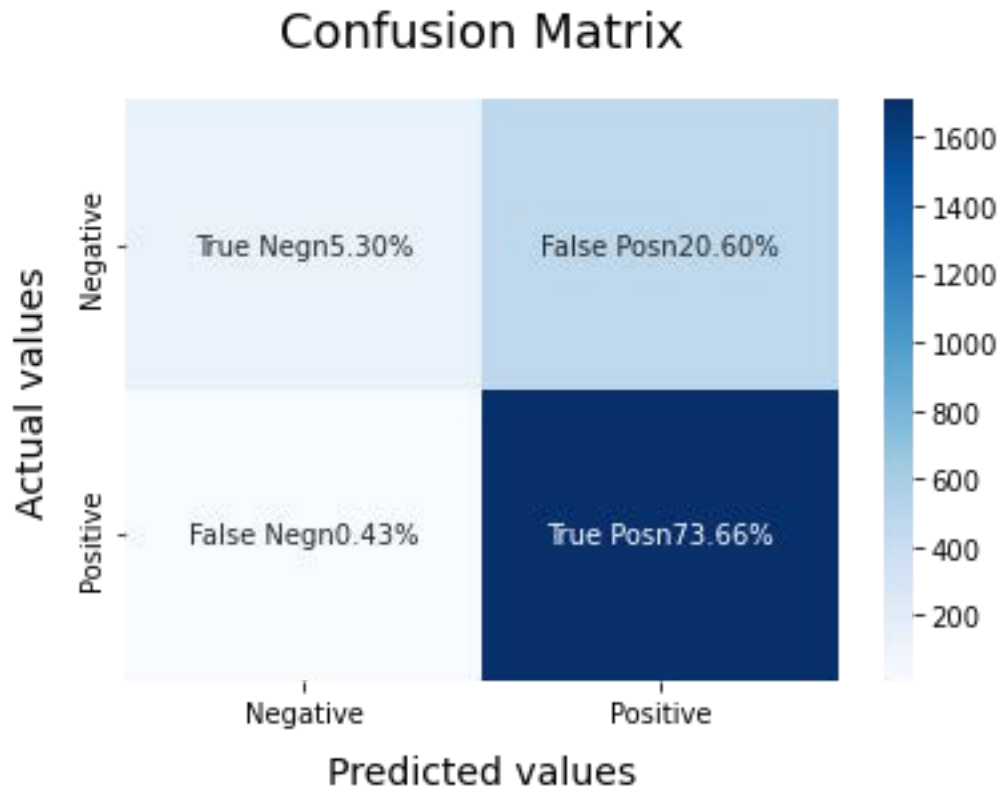

Figure 6: Confusion matrix of Regression Classifier for tweet sentiment analysis



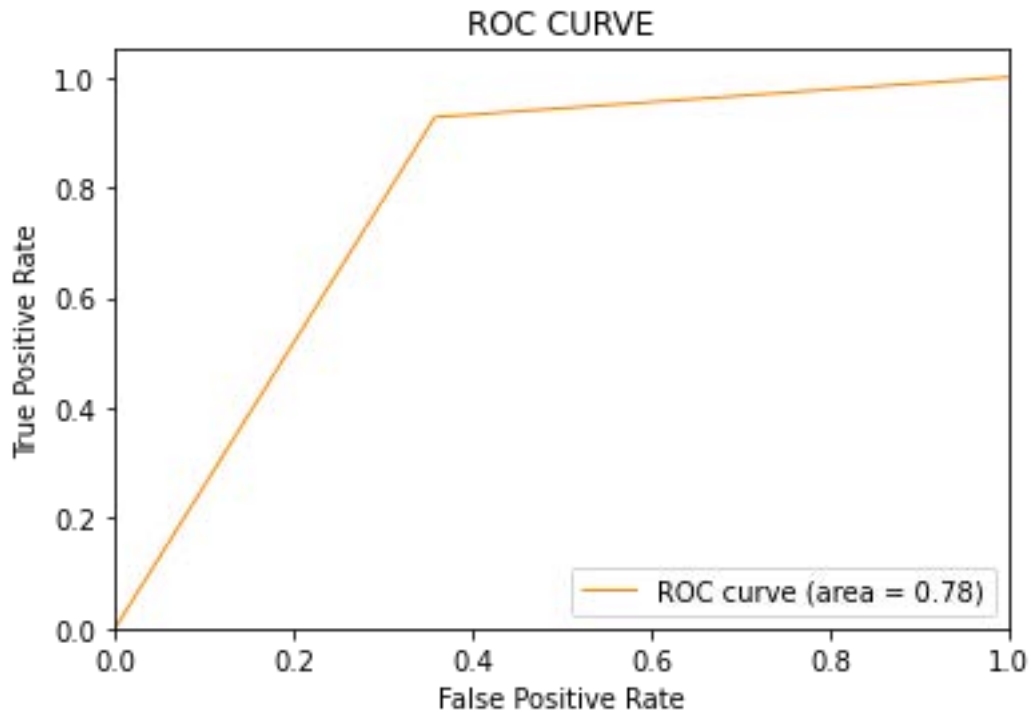

Figure 7: ROC curve of Regression Classifier for tweet sentiment analysis

The above figure 4.2 shows the graph that represents various thresholds and the trade-off between false positive rate against true rate. It shows the performance of the classification model. Our model achieved AUC of 0.78.

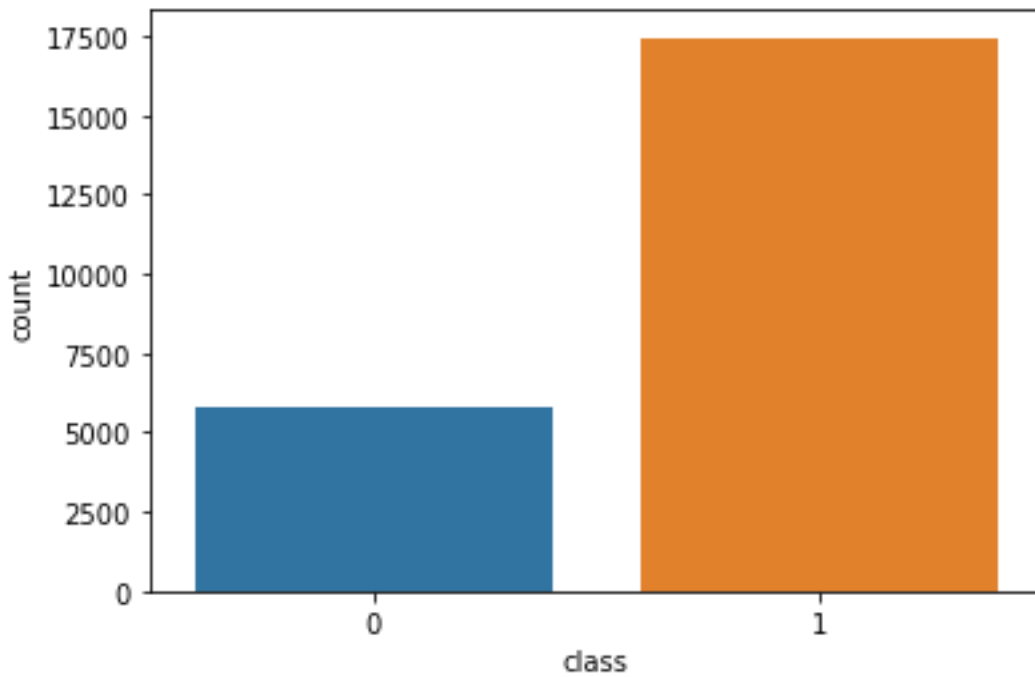

Figure 8: Number of tweet sentiment analysis in class 0 and 1

Through real-time Twitter data that was taken from the platform via the Twitter-streaming application programming interface (API), two politicians were compared (Hogenboom, Van Iterson, Heerschop, Frasinca & Kaymak). Two types of sentiment analysers that are widely used for identification of negative and positive emotions are WordNet and SentiWordNet. Word sequence disambiguation is used for negative handling and for improved accuracy of the model used (Ibrahim, Abdillah, Wicaksono & Adriani). Twitter streaming API is used for predicting presidential elections of Indonesia. The goal was to ascertain popular opinion using data from Twitter. To achieve this, the study divided each tweet into many sub-tweets for sentiment analysis after using automated buzzer identification to eliminate superfluous tweets from the data set. It then computed sentiment polarity and used positive tweets related to each candidate to predict the election outcome. Finally, it used mean absolute error (MAE) (Liben-Nowell & Kleinberg) to assess the prediction's performance and assert that the prediction was 0.61% more accurate than the conventional surveys of the same kind in Twitter analysis.

In addition to sentiment analysis, a connection structure incorporating political conversations on Twitter was examined in order to predict the results of the Swedish election. This employed a link-prediction algorithm for this purpose and showed that vote results are more closely correlated with account popularity as indicated by structural links (Miranda Filho, Almeida & Pappa). This also demonstrated that there is a substantial correlation between the general election results and the standing of particular candidates, as well as between the official party account and the results of European elections. Six Brazilian cities were tested using a developed approach (Miranda Filho, Almeida & Pappa). Sentiment analysis and a stratified sample (Foreman) of users were included in this process so that the features of the results may be compared with voters.

Tweet sentiment analysis is highly popular in recent years, and algorithms like Naïve Bayes algorithm have been used to determine the sentiments of user-generated queries. Manually annotated corpus-based hashtags and detection were evaluated for the US elections prediction in 2016, and it was claimed that a 7% accuracy level had grown (Rezapour, Wang, Abdar, and Diesner).

## **Conclusion**

The classification performance of machine learning techniques is analysed based on various performance metrics for tweets. In the present research study, the collection of tweets sentiment analysis and then classification of Twitter text using supervised machine learning techniques was performed. The tweets are considered as the user reviews posted using hashtag forms for expressing their opinions and emotions. The classification models are evaluated using a confusion matrix for analysing the performance of the models. The accuracy of various classification models like Naïve Bayes algorithm, Support vector machine and regression analysis are 0.79, 0.85 and 0.84. The graphical representation ROC curve shows various

thresholds and the trade-off between false positive rate against true rate The AUC of the models were 0.75, 0.60 and 0.78.

## Works Cited

- Medhat, W., Hassan, A., & Korashy, H. (2014). Sentiment analysis algorithms and applications: A survey. *Ain Shams engineering journal*, 5(4), 1093-1113.
- Jagdale, O., Harmalkar, V., Chavan, S., & Sharma, N. (2017). Twitter mining using R. *Int. J. Eng. Res. Adv. Tech*, 3, 252-256.
- Anjaria, M., & Guddeti, R. M. R. (2014, January). Influence factor based opinion mining of Twitter data using supervised learning. In *2014 sixth international conference on communication systems and networks (COMSNETS)* (pp. 1-8). IEEE.
- Hasan, A., Moin, S., Karim, A., & Shamshirband, S. (2018). Machine learning-based sentiment analysis for twitter accounts. *Mathematical and computational applications*, 23(1), 11.
- Ghiassi, M., & Lee, S. (2018). A domain transferable lexicon set for Twitter sentiment analysis using a supervised machine learning approach. *Expert Systems with Applications*, 106, 197-216.
- Alamoodi, A. H., Zaidan, B. B., Zaidan, A. A., Albahri, O. S., Mohammed, K. I., Malik, R. Q., ... & Alaa, M. (2021). Sentiment analysis and its applications in fighting COVID-19 and infectious diseases: A systematic review. *Expert systems with applications*, 167, 114155.
- Yadav, N., Kudale, O., Rao, A., Gupta, S., & Shitole, A. (2021). Twitter sentiment analysis using supervised machine learning. In *Intelligent data communication technologies and internet of things: Proceedings of ICICI 2020* (pp. 631-642). Springer Singapore.
- Susmitha, C., Nikhil, L., Akhil, L., Kavitha, M., Reddy, V. S. N., & Shailaja, K. (2023, February). Sentimental Analysis on Twitter Data using Supervised Algorithms. In *2023 7th International Conference on Computing Methodologies and Communication (ICCMC)* (pp. 921-925). IEEE.
- Qi, Y., & Shabrina, Z. (2023). Sentiment analysis using Twitter data: a comparative application of lexicon-and machine-learning-based approach. *Social Network Analysis and Mining*, 13(1), 31.
- Reddy, A., Vasundhara, D. N., & Subhash, P. (2019). Sentiment research on Twitter data. *Int. J. Recent Technol. Eng*, 8(2), 1068-1070.
- Jivani, A. G. (2011). A comparative study of stemming algorithms. *Int. J. Comp. Tech. Appl*, 2(6), 1930-1938.
- Twitter Apps. Available online: <http://www.tweepy.org/> (accessed on 26 February 2018).
- Hogenboom, A., Van Iterson, P., Heerschop, B., Frasincar, F., & Kaymak, U. (2011, October). Determining negation scope and strength in sentiment analysis. In *2011 IEEE international conference on systems, man, and cybernetics* (pp. 2589-2594). IEEE.
- Ibrahim, M., Abdillah, O., Wicaksono, A. F., & Adriani, M. (2015, November). Buzzer detection and sentiment analysis for predicting presidential election results in a twitter nation. In *2015 IEEE international conference on data mining workshop (ICDMW)* (pp. 1348-1353). IEEE.
- Kaggle. Mean Absolute Error. Available online: <https://www.kaggle.com/wiki/MeanAbsoluteError> (accessed on 26 February 2018).

Liben-Nowell, D., & Kleinberg, J. (2007). The link-prediction problem for social networks. *Journal of the Association for Information Science and Technology* (2007). *Google Scholar*  
*Google Scholar Digital Library Digital Library*.

Miranda Filho, R., Almeida, J. M., & Pappa, G. L. (2015, August). Twitter population sample bias and its impact on predictive outcomes: a case study on elections. In *2015 IEEE/ACM international conference on advances in social networks analysis and mining (ASONAM)* (pp. 1254-1261). IEEE.

Foreman, E. K. (1991). *Survey sampling principles*. CRC Press.

Rezapour, R., Wang, L., Abdar, O., & Diesner, J. (2017, January). Identifying the overlap between election result and candidates' ranking based on hashtag-enhanced, lexicon-based sentiment analysis. In *2017 IEEE 11th International Conference on Semantic Computing (ICSC)* (pp. 93-96). IEEE.

# **Solar Photovoltaic Carport Solution to Energy Needs in Humanitarian Aid Situations By Omar Wali**

## **Abstract**

The demand for energy worldwide is continuously increasing year on year, with traditional ways of generating power harming the environment. The purpose of this paper is to propose a sustainable solution to address the increasing demand for energy with a focus specifically on the Shatila Refugee Camp in Beirut, Lebanon. The proposed solution is to utilize a solar photovoltaic (PV) carport installment in the Camille Chamoun Sports City Stadium parking lot to supply the energy for the Shatila Refugee Camp. However, in order to research this project, concepts such as electricity, solar irradiance, carports, renewable energy, subsystems in a solar plant, and the history of the Shatila Refugee Camp needed to be well studied and summarized. After that, other studies that were written in relation to using solar power for humanitarian purposes, or solar photovoltaic carport designs were reviewed to help with this study. Next, two different iterations of carport designs were used in simulations to estimate the total power output of the installments and see whether they would sufficiently supply energy to the whole Shatila camp. Lastly, the results and discussion section revealed that the second iterations' carport design would be able to supply 14.02% of the Shatila camp's total energy demand, producing an estimated 4,383,000 kWh yearly out of the estimated 31,260,000 kWh yearly power demand. However, the main drawbacks of this installment is that it would cost upwards of \$2.5 million to build, and would need approval from the Lebanese government to build because they own the stadium parking lot.

## **Introduction**

As globalization spreads, pollution and global warming increases. In today's world, electricity has become a necessity to everyone for their day to day lives. However, since traditional ways of generating electricity use sources that harm our environment, continuing to rely on them will have devastating consequences towards our biosphere. That is why it is essential to begin using forms of sustainable energies that are environmentally friendly, with sources that naturally replenish quicker than they are used.

This research paper will be focusing on the feasibility of installing a photovoltaic solar carport farm as an environmentally friendly and renewable energy source for the Shatila refugee camp located in Beirut, Lebanon. This camp was established in 1949 to house Palestinians running away from the Palestinian-Israeli conflict ("Shatila Camp"). It has now grown exponentially but due to spacing limitations, houses are tightly congested together, built on top of each other while failing to meet safety regulations. Due to the camp's unique challenges, such as the limited space for installing an energy farm, and location having high levels of solar irradiance to power a solar farm, the photovoltaic solar carport farm seems the best way to address the energy problem. Furthermore, the installation of photovoltaic solar panels offers greater cost-effectiveness compared to alternative energy farms in the long term.

One of the biggest current problems for people residing in the camp is that they only have access to electricity for 1-3 hours each day due to the failing infrastructure within the camp, and within the city of Lebanon (Bar-On). Without electricity, they do not have access to light, heating, and cooling systems, and are cut off from the rest of the world without the internet. This severely impacts the lives of the refugees within the camp, depriving them from basic opportunities and needs medically, financially, educationally, etc.

Building a solar photovoltaic carport in the Camille Chamoun Sports City Stadium parking lot will help with providing energy for the residents in the Shatila refugee camp and has the potential to cause a massive positive impact on the lives of thousands. This paper aims to address the energy crisis faced by the residents of the Shatila refugee camp in Beirut, Lebanon. The main research question that is driving the path of this paper is as follows, will a solar photovoltaic carport be a sufficient energy source for the Shatila Refugee Camp in Lebanon?

## **Background**

### **Concepts Used in Solar Farms**

Whenever doing anything that relates to electricity generation, it is crucial to understand the difference between alternate current and direct current motors. Each motor has their advantages and benefits that make them more suitable for a specific task. The most substantial difference is that the current in a DC motor only flows in one direction, providing constant current and voltage, while the AC motor's current and voltage switch periodically. Applications of DC motors can be seen in almost all electronic devices with a battery such as phones, laptops, and flashlights (Hymel). However, AC motors are used in fans, lawn mowers, clocks, and can be seen in home and office plugs ("What Are AC Motors Used For?"). When looking at advantages, the DC motor has simpler installation, maintenance, and faster response time to starting and stopping, while the AC motor is more durable, with a longer life span, and is considered more powerful than the DC motor since it can generate higher torque by using a more powerful current (Hymel).

Some other important concepts that are used when creating a solar farm are the units and measurements of watts, volts, and current. Electric current is the total amount of charge passing through a wire over a period of time ("What is electric current?"), current is essentially electrons moving continuously in a pathway. There are many different units and terms we use to determine the power and energy of current. Current is measured in amperes, and is the rate of flowing electrons within a circuit. Voltage is used to determine how powerful a current is (Bieganski), and it is calculated by multiplying amps by watts. Another way to think of voltage is the "pressure" of the current. Watts is the energy consumed. This is usually measured in watt hours and used to calculate cost when paying a monthly energy bill. A simple analogy of a water pipe can help familiarize these terms.



Figure 1: Water Pipe Analogy for Understanding Electricity (“Understand Power”)

Lastly, the difference between power and energy should be well understood. Energy is the ability to cause change, while power is the rate of energy being used to create the change (“Energy vs power). For example, a light bulb. Power is a unit of watts, so when looking at lightbulbs with more watts that means they have more power (brighter). Energy is a unit of watt hours, how many watts are used per hour. So, the brightness of a light bulb is the power while the amount of watts it uses per hour is the energy (“What’s in a Watt? Power vs. Energy”).

### **Carport**

Carports are structures designed to shelter an area designated for a car. There are many different carport designs each aimed at protecting cars parked in the spaces from elements that can damage and wear a car. Some of the most common types are the inverted L, T, 4 legged, and V configurations. Recently, carports in commercial environments have started to be built to house solar panels on top of them. The benefits of these solar carports include leaving a reduced carbon footprint, maximizing available space, environmental benefits, and more (“Benefits of Commercial Solar Carports?”).



Figure 2: T-Carport Design (“Carport / Shading Structure”)





Figure 3: V Carport Design (“The Role of Solar Carports”)



Figure 4: Inverted L Carport Design (“Carport”)



Figure 5: 4 Legged Carport Design (“Carports Vehicle Cover”)

## Renewable Energy

In today's world, humanity relies on power to survive. However, traditional ways of harnessing energy for the world's needs has been destructive towards the environment with global warming on the rise due to carbon emissions. Due to this, renewable energy has been increasing in popularity and use. Renewable energy is a type of energy where its natural source/s replenish at a higher rate than consumed (“What is renewable energy?”). Not only are renewable

energies environmentally friendly, but they are also very efficient and cheaper to use in the long term.

Some of the different types of renewable energies include hydropower, wind, geothermal, marine wave, and tidal. Hydropower uses flowing water to generate power. It works by using the elevation difference in bodies of water such as flowing rivers to push a turbine and create power (“Hydropower Basics”). Wind energy is harnessed using turbines that are turned by the kinetic energy of air in motion to rotate a turbine which then is converted by a shaft to electrical energy (“Wind energy”). Wind farms can be used in places with consistently high wind speeds and can either be onshore or offshore. Geothermal energy is the heat energy from the Earth. It is extracted by drilling into geothermal reservoirs at various depths and temperatures. The steam or hot water from the reservoirs can be brought up to the surface and be used to generate electricity or water heating (“Geothermal Basics”). Wave energy works by capturing the movements of waves, then converting it into electricity through different devices placed in the water (“Wave energy”).

### **What is solar energy?**

Solar energy is the most abundant and sustainable energy that Earth has to offer (“What is renewable energy?”). With developments in the technological field, mankind has gained the ability to convert sunlight radiation to electricity in a variety of ways using different technologies such as photovoltaic solar panels, concentrated solar power, and solar water heating systems which will be discussed further (“The 4 Main Types of Solar Energy”).

Solar irradiance is the measure of the amount of solar energy received at one specific location (“Frequently Asked Questions”). Solar irradiance is often confused with solar radiation however they are different since solar radiation is the total amount of energy emitted by the sun. Solar irradiance is measured in three different ways, direct irradiance is the measure of the solar irradiance that reaches a surface, it is measured by a Pyrheliometer on a sun-following tracker. Diffuse irradiance is the measure of solar irradiance scattered by the atmosphere and is measured by a shaded Pyranometer under a tracking ball. Lastly, global irradiance is the sum of both direct and diffuse components reaching the same surface and is measured by a Pyranometer with a horizontal sensor. With this information, solar irradiance can be used to calculate and estimate how much solar energy can be harvested in a specific area. The formula in the schematic can be used to calculate this optimum angle. ( $GHI = DNI * \cos(\theta) + DHI$ ) (Alawneh 28).

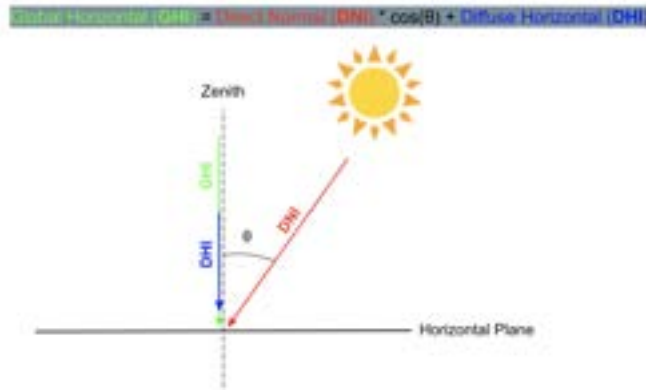

Figure 6: Diagram of what GHI, DNI, and DHI are (Alawneh 28)

One way to generate electricity from solar power is with Concentrated Solar Power (CSP). CSP farms, which are usually built in remote and flat areas, use mirrors to reflect and concentrate sunlight onto a specific point called a receiver, usually on the top of a tower which is surrounded by all the mirrors (“Solar power tower”). The receiver contains liquids such as oil, or molten salt which can hold heat well. Once the liquid in the receiver is heated up, it creates steam which can then be used to turn a turbine and power a generator (“Concentrating Solar-Thermal Power Basics”). As of 2023, Spain has the biggest number of CSP projects at 56, followed by the USA, then China (“Concentrating Solar Power Projects”).

Another option that is cost efficient are solar water heating systems. These systems use the energy of sunlight to heat up water for domestic use. The systems work by flowing water into a component called the collector which is facing the sun. As the water heats up, since hot water is less dense than cool water, it flows up an ascending pipe into the water tank, ready for use. However, there are two main systems, active and passive. The active system uses direct and indirect circulation systems. The direct circulation system is better for climates which don’t freeze, the indirect system is used in colder climates but is slightly more expensive. The second type of system is the passive water heating system which is typically cheaper but not as effective as active systems. This system uses Integral collector-storage passive systems which are essentially transparent water tanks that are directly heated by the sun, and Thermosyphon systems which have collectors on the roof that heat up the water (“Solar Water Heaters”).



Figure 7: Active, Closed Loop Solar Water Heater (“Solar Water Heaters”)



Figure 8: Passive, Batch Solar Water Heater (“Solar Water Heaters”)

The most common type of system used to generate electricity from sunlight are photovoltaic cells. The cells which are grouped into a solar panel absorb photons coming from the sun. Within these panels are a positive and negative layer which create a magnetic field. Once the photons are absorbed by the cells, the semi-conductive material frees some electrons which then generate electricity. Arguably the best benefit of solar photovoltaic systems is their ability to generate electricity anywhere as long as there are enough photons coming from the sun (“Solar Photovoltaic Technology Basics”). Some of the biggest solar photovoltaic power plants can be found in India, China, and Egypt (Sharma).

When looking at solar photovoltaic power plants, there are many subsystems set in place to actually convert the sunlight energy to electrical current. The first and most important subsystem is the solar panels themselves that are absorbing the sunlight and freeing electrons creating current (“Solar Photovoltaic Technology Basics”). Holding the solar panels in place at the most optimum angle is the mounting and racking systems. Mounting and racking systems offer versatile options for installation. They can be fixed and put on various surfaces such as the ground, roof, or carport. Alternatively, they can also be mounted with a single or double axis tracking mechanism that tracks the sun during the day and tilts during different seasons throughout the year to maximize yield from the farm. However, the double axis systems are only usually used at high altitudes where farms can’t be efficient without the systems (“Single-Axis and Dual-Axis Solar Tracker”). Then there is the balance of system (BOS) which makes up the majority of the components in a solar PV farm. Essentially it is all the components in the farm excluding the mounting and solar panel systems. The first component is the inverter which changes the direct current that the solar panels produce to alternate current which is more suitable for powering homes (“What are the main components of a solar energy system?”). Then to regulate the voltage and current coming from the panels to the battery, the charge controller is used. To optimize efficiency and limit prevent under or overcharging the Battery Management System (BMS) is set in place. Lastly, to link and connect all the components to make the farm work, high quality wires are used (“What Is BOS in Solar Power?”).

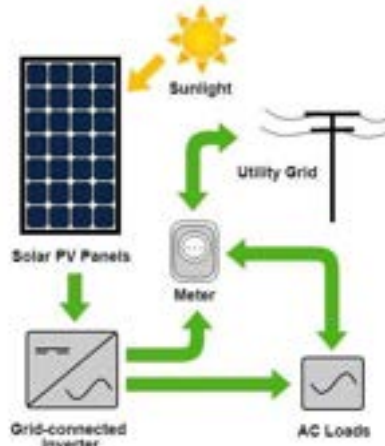

Figure 9: Grid-connected PV System (“Solar PV Systems”)

### History about the camp

In 1949, the Shatila refugee camp in Lebanon, Beirut was established for Palestinian refugees coming from the Israeli-Palestinian conflict where Zionists were violently ethnically cleansing Palestine. Initially the camp comprised 500 residential units, however it has now expanded and grown. Most of the new residential units have been built over the old ones without proper foundations. Due to the demand for residential units and limited spacing, refugees were forced to build vertically, significantly increasing risk of building collapse (“SHATILA CAMP”).

During Lebanon's 15-year civil war in 1982, Israelis invaded Lebanon and proceeded to target destroying the Palestine Liberation Organization (PLO) which was based in Lebanon and was launching attacks on Israel. The PLO withdrew from Lebanon on September 1st with assurances from the USA and a multi-national force that the remaining Palestinian refugees and civilians would be protected. Two weeks later between September 16-18, 2,000 to 3,500 people were killed when right winged Lebanese militia coordinated with Israeli forces to attack the Sabra and Shatila refugee camps along with Lebanese civilians. Testimonies spoke about mass graves, mutilations, and rape (“Sabra and Shatila massacre: What happened in Lebanon in 1982?”).

Currently, Lebanon's situation has become quite dire with the 2020 Beirut explosion causing mass destruction and hyperinflation taking over the economy (“Dozens killed as huge explosion rips through Lebanon’s Beirut”). After the explosion, fuel prices have reached a new high which makes the already bad situation in Lebanon worse. Government power was already only supplied for 1-3 hours a day, and now residents within the camp have to rely on increasingly expensive electricity subscriptions privately owned by other residents within the camp (Bar-On). However, there are still many NGOs and small companies in the camp providing humanitarian aid and opening programs to help the residents in any way. One notable NGO is Basmeh & Zeitooneh (translates from Arabic to “Smile & Olive”). They opened many successful programs such as the Women’s Workshop that taught women refugees in the camp how to embroider, then

proceeded to sell their work through the NGO's selling channels and provide the women with income to help support their families ("Women's Workshop").

#### Literature Reviews:

With the increasing demand of energy due to the increase in the amount of electric vehicles in use, a study by Robinson and Chung proposes full mechanical and economic analysis of three possible solar photovoltaic carport solutions along with their complete designs. These designs offer cost-efficient solutions that provide the needed space for the panels. All three designs have an expected lifetime of 25 years to match a standard PV-warranty.

The three designs consist of one exclusively wood single-parking-spot spanning system. The second is an aluminum and wood double-parking-spot spanning system. And the final design consists of a wood and aluminum cantilevered system for curbside parking. The first option is the most cost-efficient, costing CAD 4448.69 for 5 parking lot spaces. Please note this is excluding the solar photovoltaic panels themselves and is based on the cost of materials in Canada as of July 2022. This research paper provides economically efficient photovoltaic carport designs that can be used to generate electricity for the Shatila refugee camp in the nearby stadium parking lot (Robinson et al. 6).

Moving forward from carport designs, this research paper discusses the challenges faced when trying to implement a solar photovoltaic farm as an energy solution to two refugee camps in Rwanda. The paper goes over the implementation process of two co-conceived standalone photovoltaic-battery systems in two Rwandan refugee camps, Kigeme and Nyabiheke. The methodology for implementing the systems in each camp was to first select which communal facilities should receive energy, then create designs and implement them, and finally monitor and analyze system performance and utilization.

After nine months of the systems actively running at both camps, the results showcase low performance ratios (the ratio of actual energy output to the expected energy output of a system). One system had a performance ratio of 33% while the other was 25%. These low performance ratios were due to residents using very little of the total energy output from the photovoltaic-battery systems.

To conclude, the research paper advises three things when implementing energy interventions in refugee camps. The first is to respond to implementation and operational challenges. Refugees were not using energy due to false perceptions of reliability therefore inhibiting themselves from a resource that was available to them. It is crucial to educate them before implementing such a system to maximize its benefits. Additionally, a more thorough investigation and research on energy usage statistics should have been done before building the PV systems to limit waste of resources and have a higher performance rate. Secondly, designing systems that respect and reflect the socio-political-economic dynamics of the refugee communities that the systems are being implemented in. Lastly, introducing co-creation processes for sustainable community-based energy interventions in displaced settlements. With the information from this research paper, mistakes that were made when implementing solar panels in Rwandan refugee camps can be avoided when implementing them in the Shatila

refugee camp, thus increasing performance ratios and limiting energy wastage. (Nixon)

Further insights emerge from a field analysis of photovoltaic solar panels installation after 10 years of use in Saharawi refugee camps. Results found that even though the solar panels were of high quality, due to maintenance being non-existent, it dramatically reduced the life expectancy of the panels. This was due to failure of training the personnel that would maintain and be in charge of the installation everyday caused by the lack of cooperation between the different agencies at the camps. Without maintenance the life expectancy of some panels with burnt cells dropped from around 20 years to 7. Additionally, throughout years of use, components such as inverters have been replaced with lower nominal values further reducing the performance of the installations. To avoid lowering the life-expectancy of installations, it is necessary to organize strong training programs to educate personnel on how to operate and maintain installations. It is also critical to teach general concepts of a solar photovoltaic farm in order to know what to replace when an installation malfunctions, or a part needs to be replaced. This would exponentially increase the life expectancy of installations and the lives of the refugees living in the Saharawi refugee camps. If the advice in this research paper is heeded and applied to the Shatila refugee camp, the PV installments will have higher life expectancies, as well as be more efficient. (Fuentes et. al)

Shifting focus to broader strategies, this research paper discusses the use of off-grid solar systems for humanitarian action. Specifically, present and future private sector business strategies that would help support the growing market of off-grid solar systems made for humanitarian aid.

There are 4 different solutions discussed in the paper that use solar power to fulfill the basic needs of power needed for refugees residing in various camps. The solutions are, All-in-One, Case Portable, Transportable, and Component Modular. The All-in-One solution is a transportable watt level capacity device used for lighting capable of lasting 4-6 hours before needing to be recharged with sunlight. It essentially is a solar powered flashlight or lantern. The Case Portable solution comprises one or more cases that store solar panels, power electronics, and power management that can be quickly deployed to generate energy that can be used later on. The transportable is a mobile trailer that houses solar panels, power management, and power electronics that can be deployed quickly and easily. Lastly, the Component Modular is a traditional unpackaged engineered solar system built to fulfill the requirements of energy usage at the located site. However, this is the most expensive solution and a higher installation and service skill level.

Depending on the nature and situation of a refugee camp, the applications of both packaged and unpackaged solutions in refugee camps present great potential to help. With the packaged solutions being more catered towards temporary camps due to their low price and quick deployment, while unpackaged solutions such as the Component Modular are better suited towards permanent refugee camps with higher energy usage. The temporary solutions this research paper provides can be used in the Shatila refugee camp while the permanent PV panel installation is being built (Franceschi).

## Methods:

To predict the yearly total photovoltaic power output, two things will have to be considered. This includes the area of the installment site and amount of wattage per solar panel, which depends on the type of panel used. The first task was identifying a suitable location for the solar plant. Installing panels within the camp is not possible at this moment in time due to lack of available space, which would also make it difficult to equitably distribute the panels, and lack of resources for things such as maintenance and building security. Therefore, the next viable option with a flat area is the parking lot that belongs to the government owned Camille Chamoun Sports City Stadium. The second task involves calculating the maximum power ( $P_{max}$ ) of the type of solar panel used for the project. The Tiger Pro 72HC 550 Watt panel from Jinko was chosen as Jinko is one of the biggest solar companies on the market with more affordable, durable, and efficient products than competitors. With its  $P_{max}$  at 550 Watts at standard testing conditions (STC), the Tiger Pro is the ideal choice for this project (Ullevig). The first iteration will calculate the approximate energy output of the farm based on the full area of the parking lot. The second iteration will calculate the approximate energy output of the farm while taking into consideration the space of the carports that will be constructed and the space for roads between each row of parking lots.

During the research process, two different iterations were used to provide an estimate on the total power output of the solar farm. The first iteration consisted of 5 different estimates. These estimates calculated the total power output of the installation based on using 100%, 90%, 80%, 70%, and 60% of the parking lot's total area. This is to account for any space that might be used up by roads, space between panels, and light posts in order to get a range of estimates so one will be close to the actual energy output of the farm. The second iteration consisted of designing the carport layout on AutoCad that accounted for space needed for cars to navigate, enter, and exit the parking lot. After designing the layout and counting the number of panels that fit, this iteration will provide a closer estimate to the actual power output of the farm.

The next step is to calculate the power output of the farm. In order to do that, the number of panels that fit in the parking lot needs to be known. To calculate the number of panels that fit in each area percentage of the parking lot, the area of the parking lot is divided by the area of one panel. To obtain the area of the parking lot, Google Earth Pro was used. The area of a Tiger Pro 72HC 530-550 Watt was found on the Jinko website's specification PDF for this specific panel ("Tiger Pro 72HC 530-550 Watt").

Next, the maximum power (watt peak) of the farm is computed by multiplying the number of panels by the  $P_{max}$  (maximum power point) of each panel. Again, the  $P_{max}$  was obtained through the Jinko website's specification PDF for this specific panel. Once the maximum power is known, further analysis can be conducted to assess the farm's energy generation potential. This will have to take into account factors such as sun hours and efficiency, among others. Then, to calculate the yearly output of the farm for each percentage of the parking lot area being used, and the average output each month, the maximum power was plugged into



the website Global Solar Atlas. Other settings such as optimum solar panel tilt and solar azimuth were left at the default 27° and 180°.

Moving on to the second iteration, the next first step was to try and get a more accurate total energy output by actually plotting the carports on the parking lot and adding each individual solar panel to count the total amount of panels that fit. AutoCad was used for the 2D design of the carport layout, and Google Earth Pro for the parking lot measurements. The design was made to provide the most amount of space for the solar panels, while also being a functional parking lot. After plotting down each panel into the parking lot, and counting the total total number of panels, the steps to find the maximum power, monthly, and yearly power output of the farm were repeated for this iteration.

## Results

### First Iteration

<b>Map Data (per year)</b>		
<b>Direct normal irradiation</b>	DNI	<b>1968.3 kWh/m<sup>2</sup></b>
<b>Global horizontal irradiation</b>	GHI	<b>1904.8 kWh/m<sup>2</sup></b>
<b>Diffuse horizontal irradiation</b>	DIF	<b>654.2 kWh/m<sup>2</sup></b>
<b>Global tilted irradiation at optimum angle</b>	GTI opta	<b>2111.2 kWh/m<sup>2</sup></b>
<b>Optimum tilt of PV modules</b>	OPTA	<b>27 / 180 °</b>
<b>Air temperature</b>	TEMP	<b>21.3 °C</b>
<b>Terrain elevation</b>	ELE	<b>51 m</b>

Table 1: Map Data of Parking Lot Site

Table 1 represents map data recorded from global solar atlas's measurements at the parking lot's location. Measurements of both DNI and GHI are relatively high at 1968.3 and 1904.8 kWh/m<sup>2</sup> indicating that this is a suitable location to set up a solar farm. Temperature however is average. The most optimal way to set up the solar panels is with a 27° off the ground facing south. The terrain elevation is 51m, which will reduce energy output as the higher the terrain elevation, the more solar irradiance that can be converted to electricity.

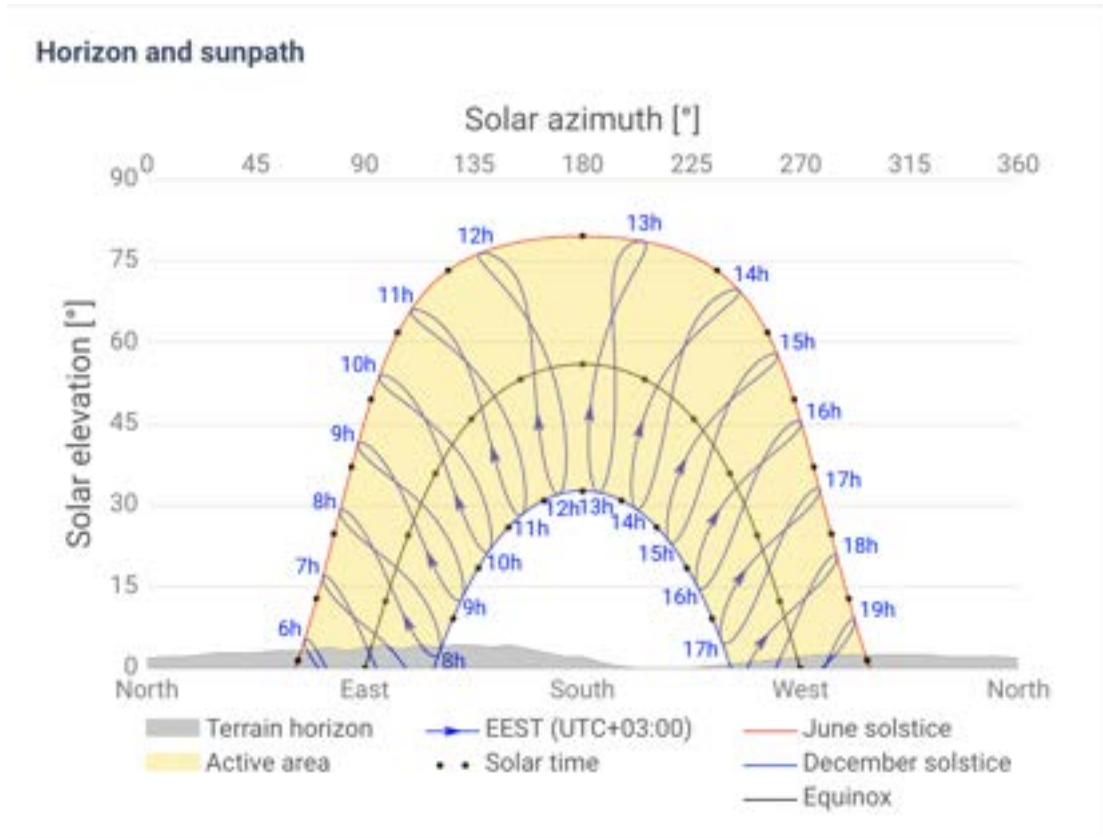

Figure 10: Horizon and Sunpath Graph of Parking Lot Site

This graph showcases the sun's path throughout the year and how it changes in different months throughout the year. At the top of the graph on the x-axis is the solar azimuth, which is the angle between north, and the sun's position at the parking lot's location. Then at the bottom of the figure are the directions of North, East, South, and West to help show the sun's relative position at different times throughout the day. Moving on, the y-axis is the solar elevation angle which is essentially the angle at which the sun appears in the sky from a specific location on the Earth's surface. After, the legend showcases a terrain horizon which is any terrain that is blocking the sun at the parking lot's location. Next is the active area, which is all the area the sun covers throughout the year. Then the red and blue lines are the June and December solstice that show the sun's path on the longest and shortest day of the year. The blue numbers and hours on the graph are used to show Eastern European Summer Time, while the figure of 8 shows the coordinates of the sun in the sky for every single day of the year. Lastly, the solar time is shown with black dots. Solar noon at this location for the December and June solstice 12h-13h

Percentage	Area of parking lot	Panels that fit	Maximum Power (watt peak)	Yearly Farm Output (GW/h)
100	20,506	7951	4,373,050	7.358
90	18,455	7155	3,935,250	6.621
80	14,764	5724	3,148,200	5.297
70	10,335	4007	2,203,850	3.707
60	6,201	2404	1,322,200	2.225

Table 2: Percentage of area of parking lot, panels that fit, maximum power, and yearly farm output in gigawatt hours

Table 2 showcases all the data that was found in order to be able to reach the end goal of calculating the farm's yearly output. The percentage of the parking lot area was divided by 2.579, the area of one panel, to get the number of panels that fit in that area. The maximum power was calculated by multiplying one of the percentages' number of panels that fit by 550, as that is the Pmax of one panel.

Months x Megawatt Hours For Different Percentages

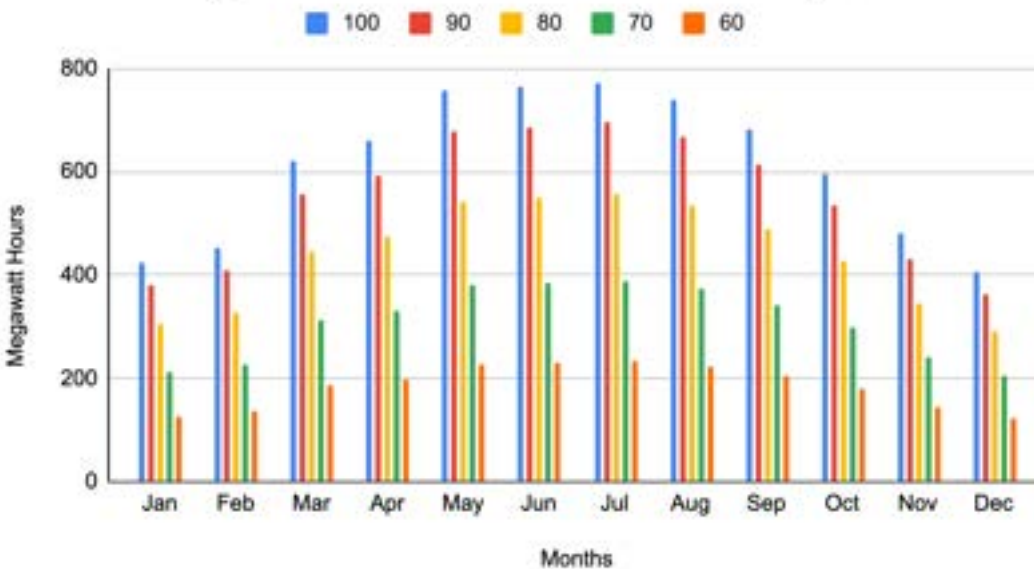

Figure 11: Graph Comparing Months and Megawatt Hours for Different Percentages

Figure 11 showcases the monthly megawatt hours estimates produced by the 5 different percentages of parking lot area. Megawatt hours is the total amount of energy produced per hour. One megawatt is one watt multiplied by  $10^6$ . July was the month with the highest megawatt

hours produced by each percentage of the parking lot area with 100% producing 773 MW/h, 90% producing 695.6 MW/h, 80% producing 556.5 MW/h, 70% producing 389.4 MW/h, 60% producing 233.7 MW/h. Meanwhile, December was the the month with the lowest megawatt hours produced by each percentage of area with 100% producing 405.4 MW/h, 90% producing 364.8 MW/h, 80% producing 291.8 MW/h, 70% producing 204.2 MW/h, 60% producing 122.6 MW/h. The yearly average for 100% is 613.2 MW/h, 90% is 551.8 MW/h, 80% is 441.4 MW/h, 70% is 308.9 MW/h, and 60% is 185.4 MW/h.

### **Second Iteration**



Figure 12: Google Earth Pro Skyview of Parking Lot

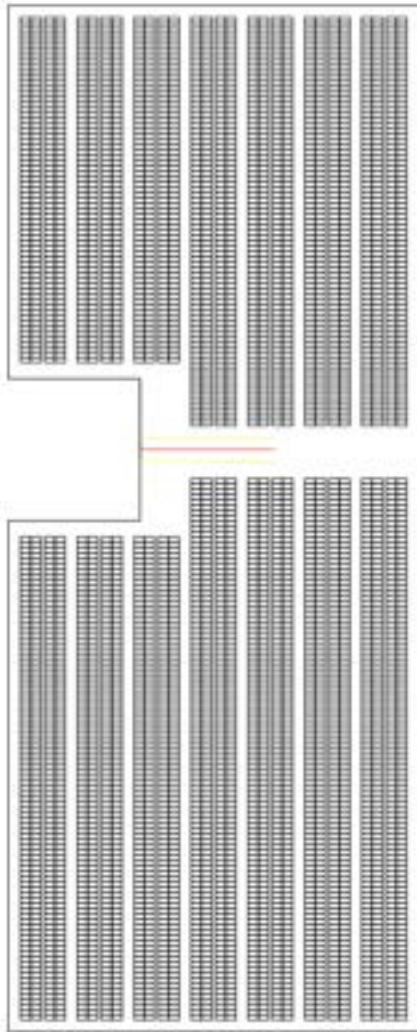

Figure 13: Parking Lot AutoCad Design:

Figure 13 is a 2D parking lot layout designed for the Camille Chamoun Sports City Stadium parking lot area on AutoCad. The distance between the red and yellow line is 2.7 meters, representing a car lane. All the rectangles represent one of the Jinko Tiger Pro 72HC 550 Watt solar panels. The carports are designed with the T configuration to fit the maximum amount of solar panels in the least amount of space. The total number of panels that fit into this design was 4,736. The maximum power calculated from this iteration of the solar farm was 2,604.8 kWp. The yearly power output was 4.383 GWh

## Second Iteration 2604.8 kWp Farm Monthly Energy Output

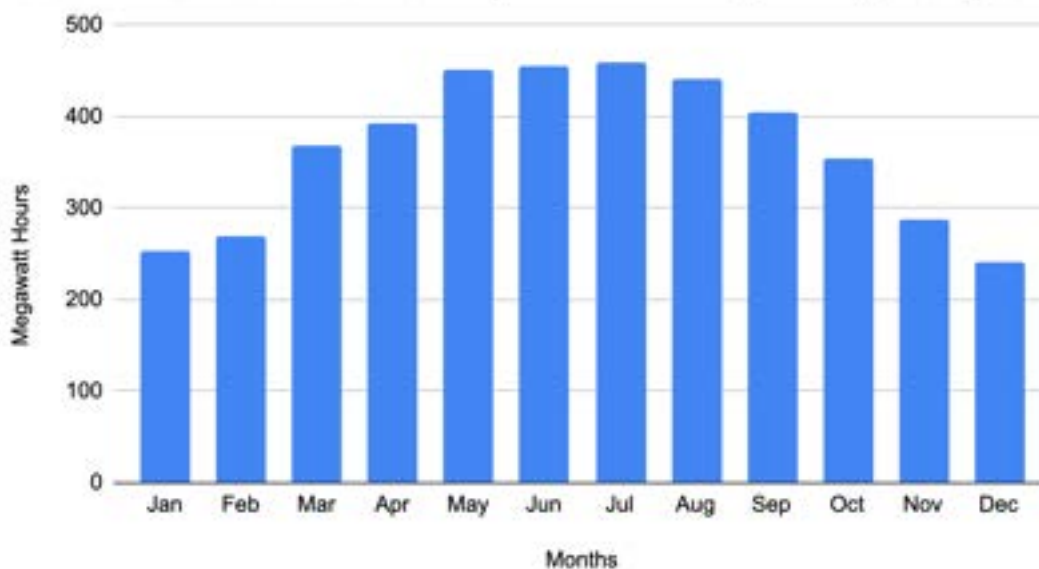

Figure 14: Monthly Average megawatt hours output of farm

Figure 14 showcases the monthly megawatt hours estimates produced by the second iteration which is shown in Table 3. July was the month with the highest megawatt hours estimate with 460.4 MW/h produced, while December was the lowest with 241.5 MW/h produced. The yearly average of megawatt hours for this iteration was 365.2 MW/h.

### Discussion

When looking at figure 10, certain factors would change how the table looks, however all these factors are based on the location of where this data is taken. The path of the sun would differ based on many different factors such as terrain elevation, latitude, obstructions, hemisphere, and more. When comparing a sunpath x horizon graph between the northern and southern hemisphere, the June and December solstices would switch places, meaning that the longest day of the year for a location in the northern hemisphere would be in June, while in the southern hemisphere it would be in December. When looking at the latitude of a location, it probably has the biggest effect on the graph. The farther a location is from the equator, the less solar elevation it will have, and vice versa. Additionally, if the chosen location has terrain obstructions such as mountains, less sunlight would strike the solar panels throughout the day meaning that less irradiance would be absorbed. This would lead to the installation producing less energy.

Moving on to figure 11 which showcases the monthly megawatt hours for each version of the solar farm, many clear patterns emerge such as July being the month with the highest amount of energy production and vice versa with December, and that the 100% version of the solar farm produces the most energy. Firstly, July is the month with the highest energy output, and

December is the lowest month due to many different factors. One factor is that the days in the summer are longer than the days in the winter for countries in the northern hemisphere like Lebanon. Another factor that contributes to this pattern is the sun angle being lower in the sky causing the rays to have to pass through a greater thickness of the Earth's atmosphere before reaching the location. This in turn causes more scattering and absorption of sunlight resulting in lower intensity of radiation reaching solar panels. Secondly, the version of the farm that uses 100% of the parking lot's area produces more energy monthly than the other versions due to it having more space to fit more solar panels. With more solar panels, energy production increases. These patterns are comparable to the results of Figure 14.

When looking at the results of this graph, the difference between each version of the farm's output values roughly stays the same, holding a linear relationship. This can be compared to the results of Table 2 where all values between each percentage version of the farm hold a strict linear relationship with each other. However, it should be noted that these figures were taken from a simulation run on Global Solar Atlas, and that these numbers would fluctuate when applying these designs in a real-world environment.

Moreover, the cost of the solar panels needed for the second iteration's installment is important to consider as it will take up the majority of the funding for this project. As of 2019, it is estimated that it will cost \$935 per kWp in a solar photovoltaic ground-mounted system (Jabbour 7). The second iteration's design has a kWp of 2,604.8 meaning it would cost \$2,435,488. However it should be noted that this is the cost for a ground mounted system and not a carport system which would require more materials, thus more money. Additionally, these prices will vary depending on location and which supplier the panels are bought from.

Lastly, to actually answer the research question, estimates of the power consumption of the camp have to be compared to the second iteration farm's output energy estimates, 4,383,000 kWh yearly, to see if that is actually a sufficient amount of energy to supply the whole farm. The refugee camp was estimated to hold around 40,000 residents in 2018, that number has grown since then but due to the severely poor infrastructure and layout of the camp, it would take more effort than it is worth to count the population ("Refugee-led Humanitarianism in Lebanon's Shatila Camp"). Most of the people within the camp live with their families, houses with 1-3 rooms holding around 6 people. Since the families within the camp mainly use electricity for fans, lights, fridges, ovens, charging phones, and televisions.

The average person in Lebanon consumes 2,583 kWh per year, however there is much less demand for power in the camp as of now ("(kWh per capita) - Lebanon"). For that reason 2,583 will be multiplied by 0.5 to try to get a power consumption estimate that is more accurate: 791.5 kWh per year. 791.5 kWh is multiplied by the camp's estimated number of residents, 40,000, to get the camp's total power consumption estimate of 31,260,000 kWh ("Refugee-led Humanitarianism in Lebanon's Shatila Camp"). Since the second iteration farm's power output is 4,383,000 kWh yearly, the farm would only be able to supply 14.02% of the Shatila Refugee Camp's power needs.

## **Conclusion**

In conclusion, after proposing to build a solar farm to provide free energy to the residents of the Shatila Refugee Camp in Beirut, Lebanon, the results show that the solar farm will only be able to sufficiently provide 14.02% of the total energy demand for the residents of the camp. However, the economic aspect of this project has to be reemphasized in that it will cost upwards of \$2.5 million due to the cost of buying thousands of solar panels, then materials for building the carport structures, and lastly the cost of labor to hire workers to build this farm. Additionally, other than the economic drawbacks, this project would require approval from the Lebanese government to build a solar farm in their stadium's parking lot.

However, when looking at the potential of this project and the amount of lives that would benefit from the power this farm would supply, the benefits far outweigh the cons. Residents within the farm would be able to use the money they originally spent on electricity for medicine, food, education, better housing, and more. This project would provide a long-awaited solution to an impossibly difficult situation that could be a pivotal point in increasing the quality of the residents living in the camp.



## Works Cited

- "AC Motors - Various Applications." American Control Electronics,  
[www.americancontrolelectronics.com/what-are-ac-motors-used-for](http://www.americancontrolelectronics.com/what-are-ac-motors-used-for)
- "Alternating Current (AC) vs. Direct Current (DC)." SparkFun Electronics,  
<https://learn.sparkfun.com/tutorials/alternating-current-ac-vs-direct-current-dc/all>
- "Balancing Solar PV Systems (BOS)." GreenTech Renewables,  
<https://www.greentechrenewables.com/article/balance-solar-pv-systems-bos>
- "Carport / Shading Structure." Patriot Solar Group,  
<https://patriotsolargroup.com/products/carport-shading-structure/>
- "Carport." Wikipedia,  
<https://de.wikipedia.org/wiki/Carport>
- "Carports Vehicle Cover." Versatile,  
<https://www.versatile.co.nz/buildings/carports/>
- "Concentrating Solar Thermal Power Basics." U.S. Department of Energy - Energy Efficiency and Renewable Energy,  
[www.energy.gov/eere/solar/concentrating-solar-thermal-power-basics](http://www.energy.gov/eere/solar/concentrating-solar-thermal-power-basics)
- "Electric Current." Hioki, HIOKI E.E. CORPORATION.  
<https://www.hioki.com/in-en/learning/electricity/current.html#:~:text=Electric%20current%20refers%20to%20the,is%20flowing%20in%20the%20circuit>
- "Electricity Use (kWh per capita)." World Bank Data,  
<https://data.worldbank.org/indicator/EG.USE.ELEC.KH.PC?locations=LB>
- "Energy vs Power." Energy Education, [energyeducation.ca](http://energyeducation.ca).  
[https://energyeducation.ca/encyclopedia/Energy\\_vs\\_power#:~:text=Energy%20and%20power%20are%20closely,energy%20is%20moved%2C%20or%20used](https://energyeducation.ca/encyclopedia/Energy_vs_power#:~:text=Energy%20and%20power%20are%20closely,energy%20is%20moved%2C%20or%20used)
- "Geothermal Basics." U.S. Department of Energy - Energy Efficiency and Renewable Energy,  
[www.energy.gov/eere/geothermal/geothermal-basics#:~](http://www.energy.gov/eere/geothermal/geothermal-basics#:~)
- "Global Solar Atlas FAQs." Global Solar Atlas,  
<https://globalsolaratlas.info/support/faq>
- "How Does a Wind Turbine Work?" YouTube, uploaded by Thomas Kim, 2 Nov. 2017,  
[www.youtube.com/watch?v=XplD4hAvXVY](http://www.youtube.com/watch?v=XplD4hAvXVY)
- "Hydropower Basics." U.S. Department of Energy - Energy Efficiency and Renewable Energy,  
[www.energy.gov/eere/water/hydropower-basics](http://www.energy.gov/eere/water/hydropower-basics)
- "JKM530-550M-72HL4-(V)-F1-EN." JinkoSolar,  
[https://www.jinkosolar.com/uploads/5ff587a0/JKM530-550M-72HL4-\(V\)-F1-EN.pdf](https://www.jinkosolar.com/uploads/5ff587a0/JKM530-550M-72HL4-(V)-F1-EN.pdf)
- "Sabra and Shatila Massacre: 40 Years On - Explainer." Al Jazeera, September 16 2022.  
[www.aljazeera.com/news/2022/9/16/sabra-and-shatila-massacre-40-years-on-explainer](http://www.aljazeera.com/news/2022/9/16/sabra-and-shatila-massacre-40-years-on-explainer)
- "Single-Axis vs. Dual-Axis Solar Trackers." Electrical Academia,  
<https://electricalacademia.com/renewable-energy/single-axis-dual-axis-solar-trackers/>
- "Solar Energy Basics." SlidePlayer,  
<https://slideplayer.com/slide/10383902/>

"Solar Photovoltaic Technology Basics." U.S. Department of Energy - Energy Efficiency and Renewable Energy,  
[www.energy.gov/eere/solar/solar-photovoltaic-technology-basics](http://www.energy.gov/eere/solar/solar-photovoltaic-technology-basics)

"Solar Power Tower." Energy Education,  
[https://energyeducation.ca/encyclopedia/Solar\\_power\\_tower#:~:text=As%20explained%20briefly%20above%2C%20a,less%20expensive%20than%20curved%20mirrors](https://energyeducation.ca/encyclopedia/Solar_power_tower#:~:text=As%20explained%20briefly%20above%2C%20a,less%20expensive%20than%20curved%20mirrors)

"Solar PV Systems." Apricus,  
<http://www.apricus.com/solar-pv-systems-29/>

"Solar Water Heaters." U.S. Department of Energy - Energy Saver,  
[www.energy.gov/energysaver/solar-water-heaters](http://www.energy.gov/energysaver/solar-water-heaters)

"SolarPACES: International Cooperation on CSP." National Renewable Energy Laboratory (NREL),  
<https://solarpaces.nrel.gov/by-country>

"The 5 Largest Solar Power Plants in the World." Ornate Solar, 2023.  
<https://ornatesolar.com/blog/the-5-largest-solar-power-plants-in-the-world>

"The Role of Solar Carports in Building a Sustainable Future." Anethic, 10 Feb. 2023,  
<https://www.anethic.com/blog/the-role-of-solar-carports-in-building-a-sustainable-future>

"Types of Solar Energy." Noviron,  
<https://noviron.com/solar-energy/types-of-solar-energy/>

"Wave Energy." Ocean Energy Europe,  
[www.oceanenergy-europe.eu/ocean-energy/wave-energy/](http://www.oceanenergy-europe.eu/ocean-energy/wave-energy/)

"What Are the Benefits of Commercial Solar Carports?" Coldwell Solar,  
<https://coldwellsolar.com/commercial-solar-blog/what-are-the-benefits-of-commercial-solar-carports/>

"What Are the Main Components of a Solar Energy System?" GEM Energy,  
<https://gemenergy.com.au/what-are-the-main-components-of-a-solar-energy-system/#:~:text=The%20four%20major%20components%20of,s>

"What Is Balance of System (BOS) in Solar Power?" EcoFlow,  
<https://blog.ecoflow.com/us/what-is-balance-of-system-solar-power/#:~:text=Balance%20of%20system%20is%20a,Inverter>

"What Is Renewable Energy?" United Nations,  
[www.un.org/en/climatechange/what-is-renewable-energy](http://www.un.org/en/climatechange/what-is-renewable-energy)

"What's in a Watt? Power vs Energy." Scope 5 Blog, scope5.com.  
<https://www.scope5.com/blog/whats-in-a-watt-power-vs-energy/>

"Where We Work: Lebanon - Shatila Camp." United Nations Relief and Works Agency (UNRWA), July 2023.  
[www.unrwa.org/where-we-work/lebanon/shatila-camp](http://www.unrwa.org/where-we-work/lebanon/shatila-camp)

"Wind Energy." International Renewable Energy Agency (IRENA),  
[www.irena.org/Energy-Transition/Technology/Wind-energy](http://www.irena.org/Energy-Transition/Technology/Wind-energy)

"Women's Workshop." Basmeh & Zeitooneh,  
[www.basmeh-zeitooneh.org/our-programs/womens-workshop](http://www.basmeh-zeitooneh.org/our-programs/womens-workshop)  
 Azhari, Timour. "Dozens Killed as Huge Explosion Rips Through Lebanon's Beirut." Al Jazeera, August 4 2020.  
[www.aljazeera.com/news/2020/8/4/dozens-killed-as-huge-explosion-rips-through-lebanons-beirut](http://www.aljazeera.com/news/2020/8/4/dozens-killed-as-huge-explosion-rips-through-lebanons-beirut)

Bar-On, Johnathan. "There's Still Time to Back Solar Power in Lebanon." Wilson Center, 2023,  
<https://www.wilsoncenter.org/article/theres-still-time-back-solar-power-lebanon#:~:text=Since%202021%2C%20Lebanon's%20state%2Drun,source%20electricity%20at%20exorbitant%20rates>

Bieganski, Paul. "Electricity Basics for Data Centers." Packet Power, 27 Feb. 2023,  
<https://www.packetpower.com/blog/electricity-basics-for-data-centers>

Franceschi, Joseph, Jaron Rothkop, and Gabriel Miller. "Off-grid Solar PV Power for Humanitarian Action: From Emergency Communications to Refugee Camp Micro-grids." *Procedia Engineering*, vol. 78, 2014, pp. 229-235. doi:10.1016/j.proeng.2014.07.061

Fuentes, M., Vivar, M., Hosein, H., Aguilera, J., & Muñoz-Cerón, E. "Lessons learned from the field analysis of PV installations in the Saharawi refugee camps (Tindouf, Algeria)." *Renewable Energy*, vol. 189, 2022, pp. 163-175. doi:10.1016/j.renene.2022.03.054

Lebanese Center for Energy Conservation (LCEC). "Solar PV Status Report for Lebanon." United Nations Development Programme (UNDP), 2021.  
<https://www.undp.org/lebanon/publications/solar-pv-status-report-lebanon-2021>

Ruddell, E. "Khrushchev, Solar Energy and the Cold War." Yale University Press, 2018,  
<https://yup.com/9780300228861/khrushchev-solar-energy-and-the-cold-war/>

Tabet, Nabil, et al. "Opportunities and challenges for Solar Photovoltaic in Lebanon: Achieving the targets." *Renewable Energy*, vol. 135, 2019, pp. 1124-1132.  
 doi:10.1016/j.renene.2018.11.073

"The Policy Brief: Solar Photovoltaic (PV) Systems in Lebanon." Green Plan,  
<https://greenplan.org.lb/wp-content/uploads/2020/07/The-Policy-Brief-Solar-PV-Systems-in-Lebanon-July-2020.pdf>

UNHCR. "Climate Action: Clean Energy in Refugee Settlements." 2023.  
<https://www.unhcr.org/climate-action/clean-energy-refugee-settlements>

Van der Berg, S., & Lier, Q. "Renewable energy in Lebanon: Status, challenges, and outlook." *Renewable and Sustainable Energy Reviews*, vol. 143, 2021, p. 110913.  
 doi:10.1016/j.rser.2021.110913

World Bank. "Electricity for All: Building Power for Lebanon." 2018.  
[https://www.worldbank.org/en/news/feature/2018/04/10/electricity-for-all-building-power-for-lebanon#:~:text=Despite%20Lebanon's%20small%20size%20\(10%2C452%20km2\),3%20million%20inhabitants](https://www.worldbank.org/en/news/feature/2018/04/10/electricity-for-all-building-power-for-lebanon#:~:text=Despite%20Lebanon's%20small%20size%20(10%2C452%20km2),3%20million%20inhabitants)

## **British Colonization as the Fundamental Cause of the Ogaden War By Julia Bae**

### **Abstract**

The Ogaden War was a major conflict in a string of constant border disputes between Ethiopia and Somalia. The proximate causes of the war are debated, with historians asserting that the Cold War influence of the Soviet Union and United States was the most prominent, with others arguing that it was the economic motivations of the two nations. This paper aims to delve one step further back in history to uncover the foundational cause of the war: the long-lasting effects of colonialism, particularly British colonial policies. At the very root, Western-made borders that established their African colonies caused the geographic separation of ethnic Somali people, which led to enduring ethnic tensions across the Ethio-Somali border. Subsequent British colonial practices of selecting local African officials based on their ethnic clan embedded the idea that ethnic and political allegiances were synonymous. As a result, the Somali government remained politically divided after gaining its independence, creating a disjointed government that was vulnerable to Mohammed Siad Barre's military coup, after which he gained dictatorial power of Somali and gave the command to invade the Ogaden.

### **I. Introduction**

In July 1977, Somali military dictator Mohamed Siad Barre invaded the Ogaden region in Ethiopia, marking the inception of the Ogaden War (Faloyin 122). Also known as the Ethio-Somali War, the yearlong conflict caused tens of thousands of deaths and captured the interest of several foreign nations. Although the element of surprise allowed Somalia to gain an initial advantage, Ethiopia ultimately emerged victorious, winning this chapter in the long and complex history of border conflict between the two nations ("Overview of Conflict in Somalia.").

Nearly ninety years prior, Great Britain and Italy established their first Somali colonies. While the nearly century-long gap between the formation of Somali colonies and Barre's invasion may make these events seem unrelated, the far-reaching impacts of Western colonialism on Somali society and politics did contribute, albeit indirectly, to the cause of the Ogaden War.

Geographically, the present day Republic of Somalia is shaped like a sideways 'V,' as the nation is the union of the former British Somaliland and Italian Somliland colonies; the Ogaden is the land area in between these two regions (Mariam 192). At the time of Barre's invasion, the Ogaden region remained within Ethiopian borders, though the land area was primarily inhabited by ethnic Somalis. As a result, the Ogaden War is understood as a manifestation of these long-standing ethnic divisions (Faloyin 122).

Essential events in the history of Somalia's colonization and independence, as well as key dates in the Ogaden War and the rise of Barre, can be found below:

1884: Berlin Conference begins.

1888: Britain makes its first treaty with Sultan Mohamoud Ali Shire to officially establish its Somali colony (Mahmoud 9).

- 1888: Italy makes various land agreements with sultans in Somali territories.
- 1897: Britain and Ethiopia enter the Anglo-Ethiopian Treaty.
- 1927: Italy unites its various regions into the singular Italian Somaliland colony.
- 1941: After the fall of Benito Mussolini's fascist rule in Italy, Britain temporarily governs both British and Italian Somaliland.
- 1954: Britain reaffirms the Anglo-Ethiopian Treaty of 1897 and withdraws British troops from the Ogaden and the Haud Region (Brown 245-64).
- 1960: British Somaliland and Italian Somaliland unite to form an independent nation, officially called the Republic of Somalia.
- 1964: Somalia and Ethiopia engage in a brief border war over the Ogaden; they reach a truce within a week.
- 1969: Mohamed Siad Barre becomes President of Somalia after his successful military coup.
- 1977: The majority of the Ogaden is controlled by pro-Somalia guerilla groups. Somalia, under the dictatorial rule of Major General Siad Barre, invades Ethiopia.
- 1978: Somalia withdraws troops from Ethiopia.
- 1991: Barre is overthrown from power.

Due to the number of factors that may have contributed to the Ogaden War, including ethnic ties, foreign influence, economic interests, and Barre's personal agenda, historians continue to debate the causes of the war. Some military analyses refer to the influence of the Soviet Union and the United States, arguing that Somalia's changing alliances with the two competing nations pressured Somalia to instigate the military conflict (Nkaisserry). Other researchers argue that Somalia was motivated by the prospect of ethnic reconciliation with the Somalis living in the Ogaden. Different historians say that the optimal trade access provided by Ogaden to the Wabi Shebelle and Ghenale rivers supplied substantial economic motivation for Somalia to annex the territory (Mariam 213-214).

While there is evidence that all of these factors may have motivated the Somali invasion, a broader perspective reveals that all of these aspects originate from the same root: the lasting impact of Somalia's colonization. Even competing scholars agree that colonialism laid the foundation for Somalia's pervasive ethnic divisions and undermined efforts to establish a unified and democratic government. British colonization reinforced Somalia's ethnic and political divisions, thus paving the way for Barre's rise to authoritarian power and serving as the overarching catalyst for the Ogaden War.

## **II. Western-Made Borders Dividing Ethnic Somali People**

European colonizers disregarded the location and movement of Somali clans when they established the Ethio-Somali border, effectively laying the foundation for future land conflicts provoked by ethnic divisions.

Similar to many other African nations, Somalia's borders were drawn by Western leaders

and separated Somali ethnic groups into several different colonies. These borders were first synthesized at the Berlin Conference in 1884, which marked the culmination of European colonization and the height of the Scramble for Africa. From November 1884 to February 1885, the leaders of European powers gathered to stake their claim over resource-rich African territories (De Leon 127, 139). While representatives from Britain, France, Germany, and other Western nations attended and signed the final declarations of the conference, there was no consideration to African leaders or voices when allocating land to European colonizers ("General Act of the Berlin Conference on West Africa, 26 February 1885.").

At the Berlin Conference, Britain, France, and Italy first claimed control over the land in the Horn of Africa. Also known as the Somali Peninsula, the Horn of Africa encompasses Somalia, Ethiopia, Djibouti, and Eritrea. Three years after the conference, Britain formalized their British Somaliland, officially titled the Somaliland Protectorate, by signing treaties with the indigenous clans living there (Mahmoud 9). Italy established Italian Somaliland in 1889. Thus, following the resolution of the Berlin Conference and its subsequent land treaties, ethnic Somali groups, including the Isak, Darod, Hawiya, and Sab people (Mariam 192-193) became divided among five geographic regions: British Somaliland, Italian Somaliland, the Ethiopian Empire of Menelik II, the Northern Frontier District of Kenya, and Cote Francais des Somaliens, which is present-day Djibouti (Bradbury 24). Inevitably, the division of ethnic Somali people across different nations fostered tensions of ethnic groups wanting to reunite.

Alongside the ethnic tensions that resulted from artificially created borders, Britain's international affairs and treaties, particularly the Anglo-Ethiopian Treaty of 1897, further created the foundation for land battles over the Ogaden. Under the Anglo-Ethiopian Treaty, Britain ceded the Haud Region of British Somaliland, which included the Ogaden, to Ethiopia ("Haud Plateau"). Britain also reaffirmed the treaty with Ethiopia in 1954; in this agreement, Britain declared Ethiopia's "full and exclusive sovereignty" over the Haud and announced the withdrawal of all British troops from the area ("Agreement between the Government of the United Kingdom of Great Britain and Northern Ireland and the Government of Ethiopia,"). However, after their founding in 1960, the newly created Republic of Somalia rejected the validity of the treaty. Since Somalia had no input in the agreement, the nation claimed that the Haud Region rightfully remained theirs ("Observations of Member States of the Draft Articles on Succession of States in Respect of Treaties Adopted by the Commission at its Twenty-Fourth Session."). Tension between Somalia and Ethiopia grew as they challenged each other and the Anglo-Ethiopian Treaty, eventually sparking a border war in February 1964 over both the Haud and Ogaden regions. Although the two nations reached a truce and ended the conflict within a week (The Associated Press), this first clash was just a prelude to the Ogaden War, when the continued border tensions escalated to a more violent conclusion.

In addition, since the colonial era, the Ogaden remained primarily composed of ethnic Somali groups (Faloyin 122), which only fueled the desire for Somalia to reclaim the region. Indeed, the Ogaden is named after the ethnically Somali Ogadeeni people, thus highlighting the strength of connection between the region and Somalia ("The Ogaden.>"). Furthermore, a large

number of Somali ethnic groups were nomadic and continued to migrate across the Haud region (“Hawd Plateau.”). Therefore, although the Ethio-Somali border had been artificially established through British policies and treaties, the ethnic ties among Somali groups remained despite these borders. As a result, border tensions were only exacerbated by the prospect of ethnic reconciliation with the Somali people living in the Ogaden. Ultimately, the division of ethnic Somali people, which was a product of colonial border formation, contributed to the Ethio-Somali border tensions and was a primary cause of the Ogaden War.

Evidence for the prominent role of ethnic ties can be seen throughout the Ogaden War. Throughout the conflict, Somali guerilla fighters were crucial for the initial success of Somali forces. Organizations such as the Western Somali Liberation Front (WSLF) and the Somali-Abo Liberation Front (SALF) made progress in fighting local government offices and officials; in fact, pro-Somalia guerilla groups controlled the majority of the Ogaden in early 1977 (Tareke 639-641). These organizations derived much of their support from ethnic Somali people living in southern Ethiopia who supported the irredentist aspect of the war (Tareke 639-640). Thus, the role of regular citizens as guerilla fighters in the Ogaden War reflects the strength of motivation for ethnic Somalis to reunite, and by association, how impactful the division of ethnic Somali people was.

### **III. Policies in British Somaliland and Subsequent Unification Challenges for Somalia**

The British method of selecting local government officials further entrenched individual clan allegiances among the Somali people, ultimately generating conflicting sentiments of national and individual clan allegiance. Consequently, the post-independence struggle to build sustainable Somali nationalism generated widespread challenges for government unity and stability.

British colonizers utilized a system of indirect rule that perpetuated divisions among Somali ethnic groups. Because it considered Somalia less valuable relative to their other colonies, Britain exerted less oversight in the colony and relied heavily on existing clan leadership systems to govern its colonial lands (Renders 36). However, in 1941, Britain altered their system of colonial governance and began ruling more actively. In 1941, which was during the midst of World War II, the Italian dictator Benito Mussolini fell from power. As a result, Britain gained temporary control over Italian Somaliland, and in order to maintain control over this larger region, Britain actively imposed new policies. For instance, the British changed British Somaliland’s capital, created new political groups including a municipal and legislative council, and formulated centralized economic development plans for both colonies (Mahmoud 11). These British-created institutions remained intact, even after World War II, when Italian Somaliland was placed under a UN Trusteeship. In the post-World War II era, British rulers managed these new political systems by selecting individuals from a variety of ethnic clans. While this process allowed for diverse clan representation, it inadvertently underscored the divisions between ethnic clans, with “clan relations becom[ing] the most prominent determinant of the political process” (Mahmoud 11). These divisions remained after Somalia gained

independence and became especially apparent as competing political parties were typically aligned with different ethnic clans (Mahmoud 11-14).

In the years immediately following its independence, the Republic of Somalia experienced a temporary period of strong national sentiment. Present day Somalia was founded by the union of British Somaliland and Italian Somaliland on July 1, 1960. Although the two former colonies harbored substantial differences in ethnic composition and political systems, Somali inhabitants of these colonies supported a united Somaliland, as it seemed to be the first step towards achieving Greater Somalia (Walz). Greater Somalia referred to the unity of the five regions where ethnic Somalis lived, including British Somaliland, Italian Somaliland, Kenya, Djibouti, and the Ogaden. The idea of Greater Somali cannot be attributed to a single person or event; rather, the concept gradually became more widespread after these five European colonies were created. Particularly after World War II ended in 1945, Somali people had begun to express their frustration with how their historic lands had been divided and split up ethnic groups as a result. In response to this growing sentiment, the British proposed the idea of uniting the two Somalilands. Britain's proposal received opposition at first, particularly from France, the Soviet Union, and the United States, as these nations had their own economic and political motives for Somalia. However, local support for the Greater Somalia movement grew even stronger during the 1950s, and after the Republic of Somalia was founded, many political parties and prominent Somali individuals advocated for the ethnic reconciliation that Greater Somalia would bring (Mahmoud 12-14). In particular, the Somali Youth League (SYL) and the Somali National League (SNL), which were the first political parties in Somalia, advocated strongly for nationalism and helped pressure the British and Italian colonies to unite (Renders 40). Similarly, the Somali National League won the first parliamentary election by promoting its belief and emphasis on Somali nationalism; they campaigned on their stated goals of improving education, promoting Somali unity, and eliminating clanism (Renders 44).

However, despite the stated goals of the leading political parties, Somalia soon reverted to a system of tribalism, as the nation was unable to overcome the internal divisions among ethnic clans that had been repeatedly enforced by colonial powers. While the SYL and the SNL advertised their support for nationalism in the first national election, looking closer at each political organization reveals that each party had essentially the same values and ideologies. Both had their main value being the unification of ethnic Somalias, with additional goals of improving Somalia's educational and economic systems. Ultimately, the main distinction between parties was their ethnic clan composition (Mahmoud 12-14).

Somalia's reversion to a political system where political parties were aligned by ethnic clans was likely a manifestation of the legacy of British colonialism. After all, the British colonial policies of categorizing political officials by ethnic clans solidified the idea that political group and ethnic clan were synonymous; ethnic identity surpassed individual ideology. The final effects of these divisions between political groups became distinctly apparent when the Republic of Somalia was forming its new system of government. Furthermore, not only did Somalia grapple with internal ethnic divisions, but they also faced tangible legal and logistical challenges.



Because the British Protectorate and Italian Somaliland were ruled under vastly different nations, the Republic of Somalia had to reconcile different legal systems, different levels and organization of government, and even different languages (Renders 45-46). Consequently, the first leaders of Somalia faced daunting challenges when trying to build a cohesive, centralized national government and a national identity.

#### **IV. Mohamed Siad Barre's Exploitation of Political Divisions to Rise to Power**

The divided political landscape in the newly founded Republic of Somalia allowed Mohammed Siad Barre to mount a successful military coup and ascend to power as a military dictator; it was this authoritarian power that allowed Barre to invade the Ogaden.

Barre rose to power in 1969 after mounting a successful coup d'état that exploited Somalia's political divisions. After a Somali policeman assassinated president Abdirashid Ali Shermarke on October 15, 1969, the Somali constitution dictated that a new president be democratically elected within thirty days (Rogers). However, the existing clan allegiances and tensions among Parliament members hindered the organization of an election and allowed the Somali military to capitalize on this power vacuum (Renders 47). Six days after Shermarke's assassination, and with the support of the police, Barre led several prominent Somali military officials in a coup that overthrew the democratic government and established a Supreme Revolutionary Council (SRC). The SRC, with total executive and legislative power, proceeded to arrest and place all existing council leaders on trial, creating space for Barre's military regime ("Somali Army and Police Seize Power."). This coup was relatively unopposed, largely because of the divisions within the Somali government that persisted since the nation's founding. Somalia's economy failed to create sustainable sources of domestic sources of income, so becoming a member of parliament transformed into one of the easiest ways for individuals to access state funds (Renders 46-47). As a result, the competition between ethnic groups over political positions became even more extreme, to the extent that five elected officials from the reigning Somali National League were assassinated during the March 1969 national elections ("Somalia: Death of a President."). Therefore, when the military seized control of the government after their coup d'état, Somali citizens were more accepting of the military reign because it signaled the end of the internally divided and constantly conflicting government.

Once in power, Barre continued to build support for his regime by addressing the pervasive clan and tribal divisions. Barre gave many speeches in which he spoke against tribalism and clanism. For instance, on May 15, 1974, Barre delivered his speech titled "Tribalism is the Worst Enemy" to all the people in the Somali capital. In this speech, Barre advocated for "Somali unity and independence" and urged people to combat their clan separation, as "tribalism still remains [colonialism's] main weapon" (Barre 347-349). Similar to how the Somali people accepted Barre's regime for the prospect of political cohesion, citizens supported Barre's speeches and his declarations of unity. In reality, however, Barre's rule contradicted his statements, as he engaged Somali forces in several military conflicts that were motivated by clan disputes (Ingiriis 1-2). For example, Barre led a 'clan cleansing' during his

rule that was essentially military sponsored killings of the Isaaq ethnic clan (Kapteijns 75). By externally portraying himself as an advocate for a national Somali identity, Barre utilized political divisions to appeal to the national sentiment and build support for himself.

Throughout his rule as an authoritarian military dictator, Barre implemented substantial changes to Somalia's government and took drastic actions on behalf of the nation—including his decision to invade the Ogaden. Barre had a strong military background, as he served in the Somali police force, attended military academy in Italian Somaliland, and became the Vice Commander of the national Somali army upon its creation in 1960 (Ahmed). Barre utilized the support of the military and police to enforce an oppressive rule on Somalia, effectively limiting the free press, independent judiciary, and other democratic components that Somalia enjoyed from 1960 to 1969. After assuming power in 1969, Barre continued to transform Somalia into an autocratic regime; some of Barre's first acts were to halt the constitution, disband the justice system (Faloyin 121), and disallow all political parties other than the Somali Revolutionary Socialist Party, which Barre created himself ("The Ogaden"). Finally, and perhaps most notably, Barre exercised his total power by giving the order to invade the Ogaden. Barre's rise to power and invasion of the Ogaden can be viewed as a product of the lasting political divisions that Somalia inherited from colonial policies.

## **V. Conclusion**

British colonialism planted the seeds of ethnic and political divisions that remained rooted in the Republic of Somalia and ultimately manifested themselves as causes of the Ogaden War. In many ways, Barre's ascent to power and invasion of the Ogaden was an inevitable consequence of European colonialism. The European creation of borders within the Horn of Africa produced geographic divisions among ethnic Somali people living in several different nations. The growing ethnic tensions across the Ethio-Somali border ultimately erupted into conflict as Somalis pushed to reclaim the Ogaden region. While the founding of the Republic of Somalia was accompanied by nationalistic calls for unity, the political environment quickly became divided by old clan allegiances. The British colonial practice of appointing government positions according to ethnic clan facilitated the formation of political parties defined by ethnic groups, which were well-established and difficult to break. These persistent political divisions ultimately allowed Barre to take control of Somalia by a military coup and empowered Barre to use his dictatorial power to initiate the Ogaden War. Thus, while external foreign interests and economic motivations may have made imminent contributions, the ultimate cause of the Ogaden War remains British colonialism and the enduring divisions it created.

## Works Cited

- "Agreement between the Government of the United Kingdom of Great Britain and Northern Ireland and the Government of Ethiopia." *Foreign, Commonwealth & Development Office*, 29 Nov. 1954, treaties.fcdo.gov.uk/data/Library2/pdf/1955-TS0001.pdf.
- Ahmed, Sundus. "Mohamed Siad Barre (1910-1995)." *BlackPast*, 26 may 2021, [www.blackpast.org/global-african-history/people-global-african-history/mohamed-siad-barre-1910-1995/](http://www.blackpast.org/global-african-history/people-global-african-history/mohamed-siad-barre-1910-1995/).
- The Associated Press. "Truce Is Reached For Somali Border." *The New York Times* [New York City], 16 Feb. 1964, [timesmachine.nytimes.com/timesmachine/1964/02/16/issue.html](http://timesmachine.nytimes.com/timesmachine/1964/02/16/issue.html).
- Barre, Maxamed Siyaad. *My Country & My People: Selected Speeches of President Mohamed Siad Barre*. 1982.
- Blanton, Robert, et al. "Colonial Style and Post-Colonial Ethnic Conflict in Africa." *Journal of Peace Research*, vol. 38, no. 4, 2001, pp. 473–91. *JSTOR*, <http://www.jstor.org/stable/424898>. Accessed 28 June 2024.
- Bradbury, Mark. *Becoming Somaliland*. E-book ed., Oxford, James Currey, 2008.
- Britannica, The Editors of Encyclopaedia. "Hawd Plateau." *Encyclopedia Britannica*, 11 Jan. 2024, <https://www.britannica.com/place/Hawd-Plateau>.
- Brown, D. J. Latham. "The Ethiopia-Somaliland Frontier Dispute." *International and Comparative Law Quarterly* 5.2 (1956): 245–264. Web.
- Daniel De Leon, The Conference at Berlin on the West-African Question, *Political Science Quarterly*, Volume 1, Issue 1, March 1886, Pages 103–139, <https://doi.org/10.2307/2139304>
- Faloyin, Dipo. *Africa Is Not a Country: Notes on a Bright Continent*. New York City, W.W. Norton & Company, 2023.
- "General Act of the Berlin Conference on West Africa, 26 February 1885." *San Diego State University*, 26 Feb. 1885, [loveman.sdsu.edu/docs/1885GeneralActBerlinConference.pdf](http://loveman.sdsu.edu/docs/1885GeneralActBerlinConference.pdf).
- Gilbert, Erik, and Jonathan T. Reynolds. *Africa in World History: From Prehistory to the Present*. 3rd ed., Boston, Pearson, 2012.
- Ingiriis, Mohamed Haji. *The Suicidal State in Somalia : the Rise and Fall of the Siad Barre Regime 1969-1991*. E-book ed., Lanham, University Press of America, 2016.
- Kapteijns, Lidwien. *Clan Cleansing in Somalia : the Ruinous Legacy of 1991*. Philadelphia, University of Pennsylvania Press, 2013.
- Mahmoud, Suhaib. "Understanding the Secession of Somaliland - فهم انفصال صومالييلاند - History of the Formation and Failure of the Somali State (1960-1991)." *AlMuntaqa*, vol. 6, no. 1, 2023, pp. 8–28. *JSTOR*, <https://www.jstor.org/stable/48718092>.
- Mariam, Mesfin Wolde. "The Background of the Ethio-Somalian Boundary Dispute." *The Journal of Modern African Studies*, vol. 2, no. 2, 1964, pp. 189–219. *JSTOR*, <http://www.jstor.org/stable/158818>.

- "Observations of Member States on the Draft Articles on Succession of States in Respect of Treaties Adopted by the Commission at its Twenty-Fourth Session." *United Nations Office of Legal Affairs*, 1974, [legal.un.org/ilc/documentation/english/a\\_cn4\\_275.pdf](http://legal.un.org/ilc/documentation/english/a_cn4_275.pdf).
- "The Ogaden." *Religion and Public Life at the Harvard Divinity School*, [rpl.hds.harvard.edu/faq/ogaden](http://rpl.hds.harvard.edu/faq/ogaden).
- "The Ogaden War: An Analysis of its Causes and its Impact on Regional Peace on the Horn of Africa." Review by Joseph K. Nkaisserry. *Defense Technical Information Center*, [apps.dtic.mil/sti/tr/pdf/ADA326941.pdf](http://apps.dtic.mil/sti/tr/pdf/ADA326941.pdf).
- Renders, Marleen. *Consider Somaliland : State-building with Traditional Leaders and Institutions*. E-book ed., Leiden, BRILL, 2012.
- Rogers, William P. "Memorandum for the President. Subject: Assassination of Somali President." *U.S. Department of State Archive*, 15 Oct. 1969, [2001-2009.state.gov/documents/organization/54641.pdf](http://2001-2009.state.gov/documents/organization/54641.pdf).
- "Somalia: Death of a President." *TIME*, 24 Oct. 1969, [time.com/archive/6637661/somalia-death-of-a-president/](http://time.com/archive/6637661/somalia-death-of-a-president/).
- "Somali Army and Police Seize Power." *The New York Times* [New York City], [timesmachine.nytimes.com/timesmachine/1969/10/22/issue.html](http://timesmachine.nytimes.com/timesmachine/1969/10/22/issue.html).
- Tareke, Gebru. "The Ethiopia-Somalia War of 1977 Revisited." *The International Journal of African Historical Studies*, vol. 33, no. 3, 2000, pp. 635–67. *JSTOR*, <https://doi.org/10.2307/3097438>.
- Walz, Jay. "Somalia Facing Grave Problems." *The New York Times* [New York City], 5 July 1960, [timesmachine.nytimes.com/timesmachine/1960/07/05/99503661.html?pageNumber=2](http://timesmachine.nytimes.com/timesmachine/1960/07/05/99503661.html?pageNumber=2).
- The World Bank. "Overview of Conflict in Somalia." *Conflict in Somalia: Drivers and Dynamics*, World Bank, 2005, pp. 9–14. *JSTOR*, <http://www.jstor.org/stable/resrep02475.8>.

# **Modeling Lunar Landing via Deep Learning and Reinforcement Learning Methods by Saaketh Suvarna**

## **Abstract**

This paper investigates how a deep learning neural network and a reinforcement learning model can enable precise and safe autonomous navigation for space vehicles. With a recent increase in interest in developing a lunar presence via the Artemis missions, the need for safe autonomous landing systems also increases. The first method utilizes a convolutional neural network trained on topographic maps of a simulated landing zone for a robotic lander. The neural network is capable of identifying global regions of interest for flat landing spots along with local solutions applied in a real mission scenario. The second method utilizes a reinforcement learning model trained on a lunar topographic map. Via simulated results with randomized landing trajectories, the reinforcement learning model was capable of identifying and assessing flat landing spots as potential landing candidates. The model efficiently calculates the best landing spots in the quickest time and can drastically increase the safety and success of future lunar missions.

## **Introduction**

Throughout the 20th century, the pace of human technological advancement is truly remarkable, yielding our pursuit of progress. Within a mere 66 years, humanity progressed through 2 monumental feats: The Wright Brothers' first flight in 1903, to the landing of the first man on the moon in 1969. The growth of technology during this era was substantial. But since then, advancements in lunar exploration have plateaued.

So why haven't we returned to the moon? Despite the challenges posed by political and budgetary constraints, the moon, with its 4.5 billion-year history, presents a significantly hazardous environment for human exploration and habitation. With its surface littered with craters and boulders, the chance of a safe landing is still a daunting task to overcome. The Apollo 11 Mission and its crew steered its way out of a potentially disastrous event for the US. At only 1600 feet above the moon's surface, Neil Armstrong's quick thinking saved the crew as he grabbed hold of the control and steered the Apollo vehicle away. The spacecraft's poor computer system had guided the crew straight into a boulder-strewn field, cutting away precious mission time as fuel sources were getting low. It's still a miracle today that the astronauts were able to touch down safely upon the Moon's surface.

Although it's been a while since we humans have touched the moon, many unmanned attempts have taken place, all facing the same challenge: landing safely. India's recent attempt at another lunar landing ended fatally. The Chandrayaan-2 Mission failed in September 2019 when the Vikram Lander crashed into the Moon's surface. Another major lunar crash took place the same year, as Israel's Beresheet lander came into a hard landing with the surface, cutting the connection with mission control and resulting in a significant setback for Israel's Aerospace Industries.

The primary objective of this project was to propose a novel approach to addressing these challenges in lunar landing. That approach involves the use of Artificial Intelligence. AI is a technological system involving the replication and enhancement of the traditional human cognitive process. It offers a new solution that surpasses human limitations in processing vast amounts of data and making real-time decisions. By leveraging reinforcement learning capabilities, this research modeled safe landing spots on the moon from elevation data. The application of this system in the case of a real mission drastically reduces the risks associated with lunar landings and allows the mission team to concentrate more on the mission's objective rather than its landing process.

## **Method: Neural Networks**

### **2.1 Neural Networks and Data Preparation**

The initial approach employed in this research was to utilize a neural network for identifying safe landing spots on the lunar surface. Neural networks are a class of AI that teaches computers to process data in a way similar to the human brain. These networks use interconnected neurons in a layered structure, effectively creating an adaptive environment in which the computer learns from its mistakes and continually improves. The initial phase of the neural network involves the preparation of the data set. The dataset is a simulated topographic map of the lunar surface, represented as a grayscale image [4]. Each pixel in the image holds a numerical value (meters) corresponding to the elevation at that point. The image is converted into a multi-dimensional array, where each element represents the elevation of a specific location on the lunar surface.

### **2.2 Neural Network Architecture**

The neural network was constructed using PyTorch, a widely used deep learning framework used for applications such as computer vision and natural language processing [10]. Neural Networks function through a series of layers, each computing mathematical operations and feeding the results through various subsequent layers.

This project utilized 3 main layers:

1. **Input Layer:** The input layer receives the lunar topographical map and elevation data. In action, it flattens the array into a single vector serving as the input.
2. **Hidden Layers:** This network includes fully connected layers, which perform linear transformations followed by non-linear activations. The primary activation function used was Rectified Linear Unit (ReLU), which introduces non-linearity into the model and allows it to learn complex patterns.
3. **Output Layer:** The final layer is a single neuron with a sigmoid activation function, outputting a value between 0 and 1. The value indicates the likelihood of a flat landing spot at that location.

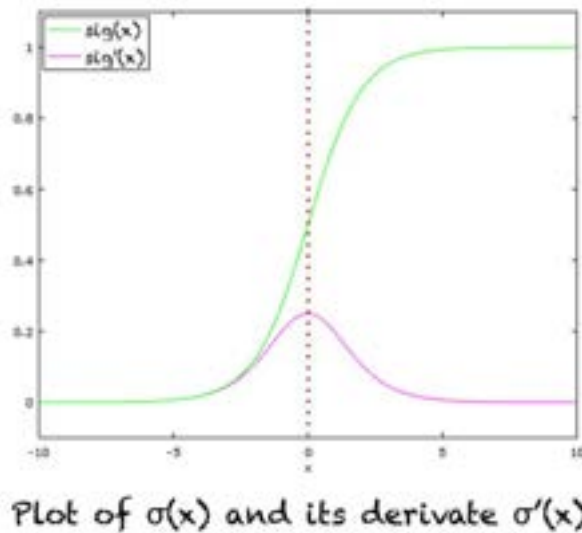

Domain:  $(-\infty, +\infty)$

Range:  $(0, +1)$

$\sigma(0) = 0.5$

Other properties

$\sigma(x) = 1 - \sigma(-x)$

$$\sigma(x) = \frac{1}{1 + e^{-x}} = \frac{e^x}{e^x + 1}$$

$\sigma'(x) = \sigma(x)(1 - \sigma(x))$

Figure 1: Sigmoid Function Information Chart including normal graph & derivative graph, and various properties of the function [1].

The sigmoid function is a squashing function returning a value between 0 and 1. The derivative of the sigmoid function as shown in Figure 1 is crucial for backpropagation, which adjusts the weights during training.

### 2.3 Training Process

The training process consisted of feeding the neural network with randomized elevation data and adjusting the weights to minimize the error between the predicted and actual values. The Mean Squared Error (MSE) is the primary function used for training. Since the Mean Squared Error (MSE) involves squaring the errors, it invariably results in a positive value. During training, a backpropagation algorithm is employed to compute the gradient's loss with respect to the network's weights. The information is then passed to update the weights with Adam, a reliable optimization algorithm. The training is conducted over multiple epochs, with each epoch consisting of a forward pass (predicting output) and a backward pass (updating the weights). The training is continued until the maximum number of epochs is reached.

### 2.4 Results and Evaluation

After training, the model is evaluated using a separate validation dataset. The performance of the neural network is assessed by its ability to predict safe landing spots on the lunar surface accurately.

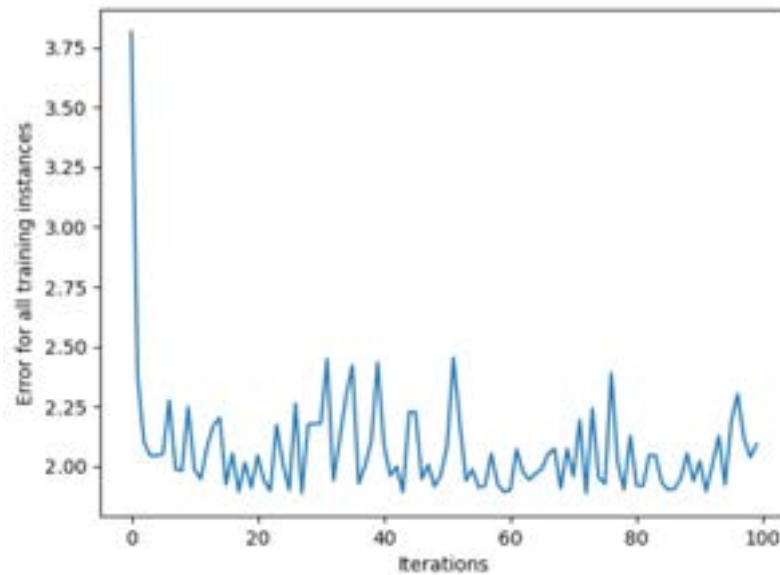

Figure 2: Training Error Results Over 100 Iterations

As shown in the figure, the error decreased significantly during the initial iterations and stabilized as it went on. This data indicates that the neural network is learning effectively and improving its predictions. The initial sharp drop in error highlights rapid learning, while the repeated fluctuations after indicate the model's effort to tune its weights and biases for optimal performance.

## 2.5 Challenges and Limitations

Despite the potential, the neural network faced several challenges during its application:

1. **Poor Data Representation:** The neural network relies on static elevation data, which does not account for the dynamic nature of lunar landings. In the depth of a mission, real-time adjustments are crucial to the safety and success of lunar landings, which the neural network struggles to handle effectively.
2. **Generalization to Unseen Data:** While the network thrived in its training data, it was only applicable to that nature, and struggled with unseen data maps. This limitation is crucial for lunar landings, as environmental changes vary significantly on the moon.
3. **Lack of Sequential Decision-Making:** The neural network does not inherently support sequential decision-making, a key component in navigating and selecting flat landing spots. The AI network should make sequential decisions based on its state, as factors in a mission are subject to change

Given these limitations, it was apparent a more accurate approach was needed to address the complexity of lunar landings. Of all, reinforcement learning emerged as a promising alternative, offering flexibility and strong decision-making abilities.



## Method: Reinforcement Learning

### 3.1 Background

A more effective application of AI was a better fit for this type of project: Reinforcement Learning. Reinforcement learning is an example of machine learning, which focuses on the use of data and algorithms to imitate the way humans learn, thus gradually improving accuracy over time. Reinforcement learning is a training method within machine learning, based on rewarding desired behaviors and punishing undesired ones. The reinforcement learning model involves two objects: the agent, and the environment. The agent is the entity taking actions within the environment and is the learner of the system. The environment is an external system in which the agent interacts with, and receives feedback. Through trial and error, the agent learns through these interactions, in which we reward as positive or negative as feedback to the agent.



Figure 3: Reinforcement Learning Cycle

The model above shows its function. The agent is placed within an environment, and from there takes observation of its surroundings. Based on the data it collects, the agent specifically chooses an action within the environment, which will be evaluated with a reward function. This ensures the agent will know if it's doing the right thing, or if it should take another action.

### 3.2 Custom Environment

In the MoonLander, a custom environment was built for the agent to interact through. The environment used includes a map of the moon's elevation data[3]. The photo is shaded accordingly, with each pixel attaining a numerical value of its height determined by its shade. The environment model takes the data, and converts it into an array of numbers, signifying the elevation points around an area. The observation space is the maximum area the agent is capable

of exploring. Setting the dimensions of the observation space relative to the image dimensions ensures the agent will not choose a landing spot outside of what is given.

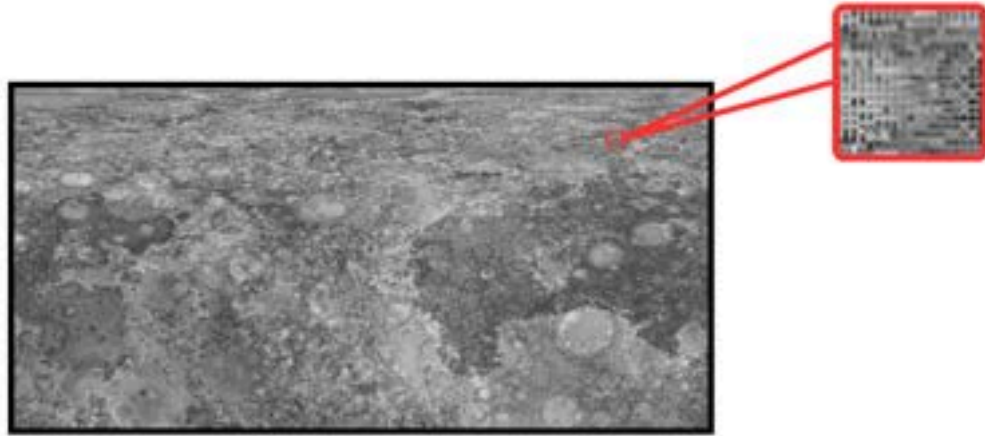

Figure 4: NASA elevation map of the lunar surface sourced from Lunar Orbiter Laser Altimeter (LOLA)

Note if this model was applied in a real mission scenario, a different image would be imputed into the environment. The idea would be that the space vehicle would be close enough to take an accurate picture of the moon's surface from its perspective, in which the model would compute a landing spot instantaneously. To simulate a real-time scenario, a random sector of the moon elevation image was zoomed into and cropped out [3], and the AI accurately found a landing spot relative to the rover's location. The radius of the image is 1737.4km, and the sector shown above is a 17.4km by 17.4km sector. During Artemis III, NASA rendered through 13 landing region candidates each with a region approximately 15x15 kilometers. This system would best accurately reflect the variability as seen in a real mission.

### 3.3 Action Steps

The next section defines the agent's possible actions. A step function is defined, in which an action is passed through. The possible actions set for the agent include movement in all 4 directions (up, down, left, right). Since the environment image is already converted into an array sequence, the actions move the agent one step in the x or y direction depending on the movement, and updates its new location with an array. A 5th action is also available: Termination. This action clarifies that the agent's location is already a flat spot, and no more actions should be taken. When the agent is ready to step in, it first checks if it should be terminated, and if not, it continues taking action until the termination action has been taken.

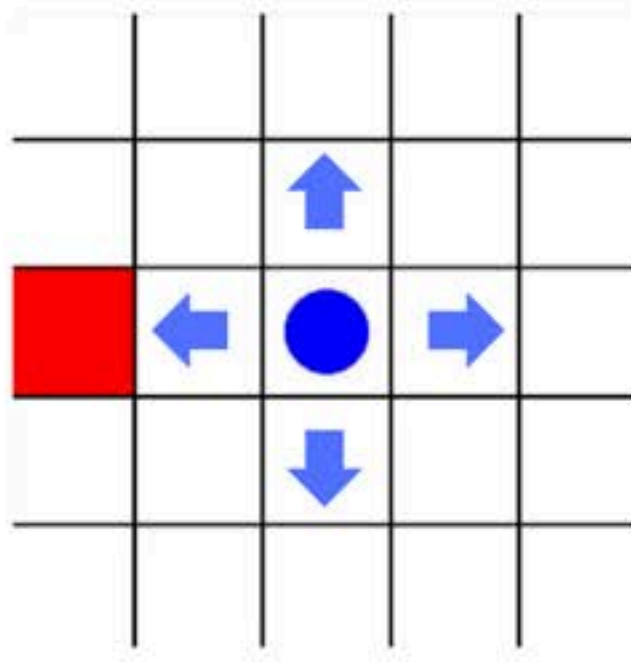

Figure 5: A grid image representing the agent's possible actions shown by the arrows

### 3.4 Reward Function

The reward function is critical in guiding the agent to learn and make decisions that will lead to a successful and safe landing. It helps the agent evaluate the desirability of different states and actions. The MoonLander calculates the cumulative reward by taking into account the surrounding values of the agent's location.

#### COMPONENTS

1. The elevation data of the lunar surface is translated and represented as an array  $E$ , where each element  $E_{ij}$  denotes the elevation at the point  $(i, j)$ .
2. The agent's current location on the map is noted as  $L = (x, y)$ .
3. The radius of elevation is set to **1**. This means the function will evaluate the values of immediate neighboring points one pixel around the agent's location. This includes the points adjacent to the position (up, down, left, right, and diagonally adjacent).

#### STEPS

First, the average elevation  $\bar{E}$  of the points within the radius of the agent's location is calculated. Let  $S$  be the set of surrounding points within the radius. The average elevation is computed as:

$$\bar{E} = \frac{1}{|S|} \sum_{(i,j) \in S} E_{ij}$$

Next, the deviation  $D$  is calculated of each surrounding point from the average elevation  $E$ . The deviation is the sum of the absolute differences between each surrounding point's elevation and the average elevation  $E$ .

$$D = \sum_{(i,j) \in S} |E_{ij} - \bar{E}|$$

A threshold  $T$  is set to 100. This threshold is a reference value used to scale the reward. Finally, the reward  $R$  is calculated based on the deviation  $D$ . The reward function is designed to provide a higher reward for smaller deviations (flatter areas) and lower to no reward for larger deviations (uneven areas). A zero is passed through to ensure the reward is non-negative. If the deviation  $D$  is larger than the threshold  $T$ , then the reward becomes 0. The unit for the reward function is dimensionless since the units (meters) cancel out. It only provides a scalar value representing the desirability of the agent's current state with a value ranging from 0 to 1.

$$R = \max\left(0, \frac{T - D}{T}\right)$$

#### EXAMPLE

To illustrate how the reward function works, let's consider an agent located at a point where the surrounding elevations within a radius 1 are given:

$$E = \begin{bmatrix} 101 & 100 & 102 \\ 99 & 98 & 100 \\ 100 & 102 & 101 \end{bmatrix}$$

The average elevation  $E$  around the agent's location is calculated as:

$$\bar{E} = \frac{101 + 100 + 102 + 99 + 98 + 100 + 100 + 102 + 101}{9} = 100.33$$

Next, the deviation  $D$  from the average elevation is calculated as:

$$D = |101 - 100.33| + |100 - 100.33| + |102 - 100.33| + |99 - 100.33| + |98 - 100.33| \\ + |100 - 100.33| + |100 - 100.33| + |102 - 100.33| + |101 - 100.33| = 8.67$$

The Reward  $R$  is finally calculated using the threshold  $T = 100$ :

$$R = \max \left( 0, \frac{100 - 8.67}{100} \right) = \max (0, 0.9133) = 0.9133$$

Thus, the agent receives a reward of 0.9133, indicating a relatively flat area. By utilizing this reward function, the agent is trained to seek out areas with minimum elevation deviation, leading to more precise and safer lunar landings.

## **Training**

### **4.1 Image Selection and Environment Setup**

The first step of the training process involves importing the environment which are the elevation maps of the lunar surface [3]. These maps are grayscale images with each pixel attaining a numerical value representing the elevation at that point. The environment class reads these images and converts them into an array system, serving as the agent's exploration space during the training process. Converting into an array allows the agent to read, interpret, and store data about the surface elevation which it will use to take an action step.

### **4.2 Agent Initialization and Actions**

The agent is initialized at a random location within the environment to best simulate the variability in real lunar missions and better test the model on its accuracy. It can take 5 possible actions, being up, down, left, and right. The 5th action is a termination action, which signals the agent a safe landing spot is found and no other action steps are needed. The AI model checks the terminate option first before proceeding with the basic action steps.

### **4.3 Training Steps and Iterations**

The training model used is Stable Baselines 3, a set of improved RL algorithms based on *OpenAI Baselines* [5]. A baseline is a method that uses a variety of actions (heuristics, randomness, machine learning, etc.) to create predictions for a data set. These predictions are further utilized in analyzing the model's performance. From Stable Baselines, two functions are imported: DQN and Evaluate\_Policy.

**Deep Q-Network (DQN):** DQN is a popular reinforcement learning technique best suited for tasks with sequential-decision making. The training process involves the agent interacting with the environment over 10,000 steps, and adjusting its strategy based on the rewards it receives from its actions taken. The key innovation in DQN aside from other RL algorithms is its unique use of experience replay. In this technique, the agent's past interactions (existing state, rewards, actions, previous states) are stored in a replay buffer. During training, random samples from this buffer are used to train the network. This helps break the cycle of repeated experiences, leading to better generalization and greater accuracy in learning. The continuous learning process updates itself and ensures the algorithm gets better over time.

Evaluate Policy: The evaluation policy is used after training to evaluate the model's performance and runs the agent through multiple episodes. This evaluation calculates the mean and standard deviation of the rewards obtained.

#### 4.4 Memory and Data Structure:

The memory required for storing the experience replay buffer involves several GB of storage. A GPU was also highly recommended and utilized to improve training speeds. The GPU used to train the system was the *NVIDIA GeForce RTX 3070 Graphics Card*. The data is stored in the form of arrays as numerical values. This data includes states, actions taken, and rewards received.

#### Results

Once the model had finished the training process, Matplotlib was used to plot the reward results utilizing the data provided by the Evaluate Policy. This visualization shows the agent's learning process over a period of iterations. As shown in the figures below, the fully trained model is effectively capable of finding a flat landing spot, as indicated by the high reward.

The model is also efficient in its calculation, represented by the quick reward increase in the shortest amount of steps. The spike to a high reward within a short amount of iterations indicates a smaller deviation within that area resulting in a flatter landing location.

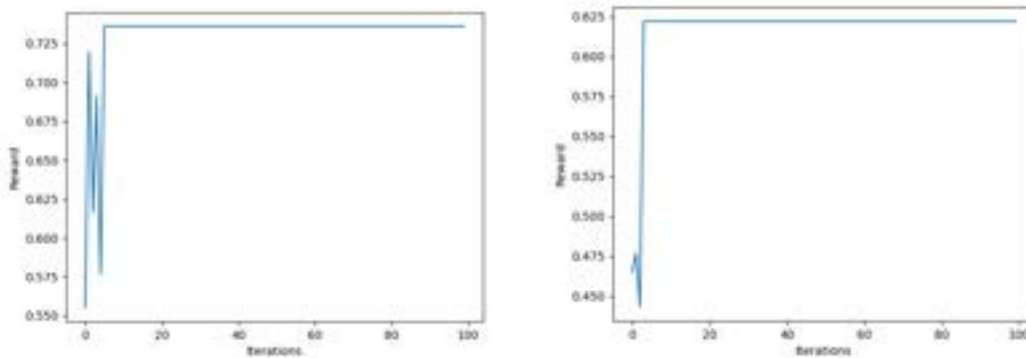

Figure 6: Training Results from Matplotlib.

Nearing the beginning stages of training, the model took more iterations to achieve a high reward, taking around 750-1000 iterations to achieve an award of around 0.5. As the model improved over time, it now takes under 20 iterations and its reward ranges from 0.625-0.9, showcasing the adaptive learning capabilities of reinforcement learning.

#### Conclusion

This study has systematically explored the integration of neural networks and reinforcement learning algorithms within space exploration, enhancing the precision of landing. The development and successful simulation of a reinforcement learning model represent a

significant advancement in autonomous vehicle navigation. The model's capability of locating safe lunar landing zones addresses the critical challenge attempted and failed by many countries: ensuring safe and precise landing for the spacecraft.

The results of the MoonLander indicate the application of AI in space missions, particularly in challenging environments such as the Moon, can substantially increase the success rate and overall safety of these missions. The MoonLander demonstrated remarkable accuracy and efficiency in real-time scenarios, suggesting its potential application in upcoming lunar missions.

The implications of this research extend beyond the lunar domain. The methodology used could be instrumental in exploring future celestial bodies, furthering our quest to unravel the mysteries of our solar system. Integrating AI in space technology not only enhances current exploration capability but opens a new horizon of learning for future planetary missions.

While the results achieved by the MoonLander were indeed promising, they represent only the initial phase in a broader journey of innovation. Looking ahead, there are significant opportunities to extend the capabilities of AI. A key area for future research involves enhancing the model's understanding of lunar topography, moving beyond the primary objective of a safe landing. The next logical step is to train the model with the ability to not only find optimal landing sites but also plot efficient and safe traversal paths for rovers on the lunar surface. The paths generated by the models would be tailored to the specific goals of the real-time mission it is implied in. The utilization of these algorithms represents a greater step forward in lunar landing, potentially transforming how rovers are deployed and managed on extraterrestrial surfaces.

## **Acknowledgments**

I would like to acknowledge all those who provided me with the opportunity and support to complete this research paper. I would also like to express my gratitude to my mentor, Cody Waldecker, whose unwavering support and guidance were instrumental.

Cody's expertise and insightful suggestions significantly shaped the direction of my project. His dedication to aerospace engineering and strong computer science skills provided me with insightful guidance in understanding and developing my project. From the initial conception of neural networks to the final stages of the reinforcement learning model, Cody played a major role, and I would have not been able to complete this research without him.

## Works Cited

- [1] Kyurkchiev, Nikolay, and Svetoslav Markov. *Sigmoid Functions: Some Approximation and Modeling Aspects*. LAP LAMBERT Academic Publishing, 2015.
- [2] Li, Yuxi. "Deep Reinforcement Learning: An Overview." *arXiv preprint arXiv:1701.07274* (2017).
- [3] NASA's Scientific Visualization Studio. "NASA." *NASA*, <https://svs.gsfc.nasa.gov/cgi-bin/details.cgi?aid=4720>. Accessed 22 Jan. 2024.
- [4]"Environment Creation." *Gym Library*, [https://www.gymlibrary.dev/content/environment\\_creation/](https://www.gymlibrary.dev/content/environment_creation/). Accessed 22 Jan. 2024.
- [5]"OpenAI Baselines: DQN." *OpenAI*, <https://openai.com/research/openai-baselines-dqn>. Accessed 22 Jan. 2024.
- [6] Brady, Timothy, and Steve Paschall. "The Challenge of Safe Lunar Landing." *2010 IEEE Aerospace Conference*, 2010, pp. 1-14.
- [7] Shyldkrot, H., et al. "The First Commercial Lunar Lander Mission: Beresheet." *Proceedings of the AAS/AIAA Astrodynamics Specialist Conference*, 2019, pp. 11-15.
- [8] "Artemis." *NASA*, <https://www.nasa.gov/specials/artemis/>. Accessed 22 Jan. 2024.
- [9]Li, Zhong, et al. "A Survey of Convolutional Neural Networks: Analysis, Applications, and Prospects." *IEEE Transactions on Neural Networks and Learning Systems*, vol. 33, no. 12, 2021, pp. 6999-7019.
- [10]"PyTorch Documentation." *PyTorch 2.3 Documentation*, PyTorch, 2024, <https://pytorch.org/docs/stable/index.html>. Accessed 28 June 2024.



# **Harmonizing with the Mind: Exploring the Influence of Music Genres on the Mood and Behaviors of Psychopaths by Juliet Proscope**

## **Abstract**

This literature review explores the differential impact of music on the cognition of psychopaths compared to the general population, focusing on how variations in brain structures, emotions, and behaviors contribute to these differences. Music universally triggers emotional and physiological responses, engaging the brain's pleasure centers and potentially benefiting conditions such as depression, Parkinson's disease, and premature birth through dopamine release and enhanced immunity. The Mozart Effect, which suggests a temporary boost in spatial-temporal reasoning from listening to Mozart's sonata K448, is examined, including its controversies and varied reproducibility. Additionally, the paper delves into the influence of extreme music genres like heavy metal on emotional states, particularly anger, and associated behaviors such as aggression and substance use. Findings indicate that while extreme music may temporarily elevate hostility, it can also serve as a tool for emotional regulation. The study underscores the complexity of music's impact on behavior and cognition, advocating for further research to elucidate the underlying mechanisms and practical applications.

**Keywords:** psychopath, music cognition, emotional response, brain structure, dopamine release, Mozart Effect, spatial-temporal reasoning, extreme music, anger processing, neuroplasticity

## **Introduction**

True crime television shows often depict psychopaths engaging in dangerous criminal activity, but what triggers these actions? Although television provides an entertaining lens into the world of psychopathy, psychopathy in the real world is often overlooked and requires more consideration and research. In society, people with psychopathy may be grappling with emotions characterized by anger or impulsivity, and ongoing research seeks to uncover the factors that trigger these emotional responses. One factor that could possibly affect these actions is music, which has both positive and negative effects. Listening to music affects the release of neurotransmitters, such as dopamine, influencing a person's mood and behavior (UAGC Staff Member, 2021). Dopamine, often referred to as the "feel-good" neurotransmitter, is a type of neurotransmitter, a chemical messenger that plays a crucial role in transmitting signals in the brain and other areas of the nervous system. Nonetheless, specific music genres produce different outcomes with each person depending on brain structure. Because many people with psychological conditions have abnormal brain structures, individuals with disorders such as psychopathy may have different responses to music (Deming et al., 2022). The connection between psychopathy and music has not been widely studied, leading to the research question: how do different music genres impact the mood and behaviors of psychopaths? This research paper will discuss psychopathy and psychopathic traits and the effects of music on different brains, and it will present an analysis of different scales and data. Music influences the cognitive

and emotional processes of psychopaths differently than the neurotypical population due to unique brain structures and emotional responses, which has significant implications for therapeutic practices.

## **Psychopathy**

### **Behavioral Traits, Development, and Neurocognitive Aspects**

Psychopathy is a psychological disorder characterized by personality traits such as antisocial behavior, lack of empathy, and the tendency to act on impulses (Anderson and Kiehl, 2014); these traits often present conflict in relationships and work. For example, the hallmark feature of psychopathy is an emotionless disposition, which may lead to behaviors causing physical, social, or financial harm, with the individual frequently exhibiting a lack of remorse or guilt (PsychopathyIs, 2023). Psychopaths often distance themselves from society and use manipulation tactics to achieve their desires. For instance, an individual can act on emotionless impulses without feeling guilt, resulting in the loss of relationships because they did not consider the emotional consequences for others. In society, psychopaths tend to engage in, rather than avoid, illicit behaviors that may present legal consequences (PsychopathyIs, 2023).

In addition, research suggests that psychopathy often stems from development, where notable genetic risk factors establish persistent traits, many of which appear before the age of 10 (Anderson and Kiehl, 2014). Despite genetic and environmental predispositions, an individual can still avoid inheriting psychological disorders such as psychopathy. Children and adolescents with a combination of psychopathy and severe conduct disorder are prone to causing significant trouble and harm to others and their environment (Bjørnebekk and Mørkrid thøgersen, 2021). Their antisocial behavior tends to develop into a chronic pattern early in life, and treatment prognosis in adulthood is poor. A large proportion of serious violent crimes in society can be attributed to this group (Bjørnebekk and Mørkrid thøgersen, 2021). Although people with psychopathy commit up to 40% of violent crimes in the United States, and comprise an estimated 25% of the prison population, not all people with psychopathy partake in criminal activity (PsychopathyIs, 2023; De Brito et al., 2021). Early signs of callous-unemotional (CU) traits, such as lack of empathy, indifference to others, and disregard for their own performance, are observed in children with persistent behavioral problems and serious norm violations (Bjørnebekk and Mørkrid thøgersen, 2021). CU traits are considered a precursor to psychopathic traits in adulthood (Bjørnebekk and Mørkrid thøgersen, 2021).

Effective measures and interventions are needed to prevent and change these traits in children and adolescents to reduce serious crime in society (De Brito et al., 2021). Life-course research has shown that early signs of both antisocial traits and behavior can lead to a chronic pattern of norm-transgressive behaviors in adulthood (Bjørnebekk and Mørkrid thøgersen, 2021). There is a consensus that early signs of serious norm-transgressive behavior can be identified, but there are moral arguments against diagnosing children and adolescents with antisocial personality disorder or using the term "psychopathy" for them (Bjørnebekk and Mørkrid thøgersen, 2021). Instead, the term "callous-unemotional traits" is used to designate these early

signs, which include little concern for others, lack of remorse or guilt after norm violations, and not caring about their performance (Bjørnebekk and Mørkrid thøgersen, 2021).

Effective treatment models have been developed for children and adolescents with severe behavioral problems, and several interventions have shown significant reductions in problematic behavior (Bjørnebekk and Mørkrid thøgersen, 2021). Now, established evidence-based treatment methods for behavioral problems are being evaluated for their effectiveness in the presence of CU traits (Bjørnebekk and Mørkrid thøgersen, 2021). Additionally, interventions aimed at changing factors linked to the development of psychopathic traits are being developed and studied.

Callous-unemotional (CU) traits in children appear to develop in their interactions with their surroundings from an early age (Bjørnebekk and Mørkrid thøgersen 2021). Factors like empathy, helping others, lying about naughty behaviors, and understanding right from wrong start to develop around the age of 2-3 (Bjørnebekk and Mørkrid thøgersen 2021). The child's parents and their interaction with the child play a crucial role in this development (Bjørnebekk and Mørkrid thøgersen 2021).

Research on the relationship between parenting practices and CU traits in children has shown ambiguous findings. Some studies suggest that a lack of parental affection or excessively strict parenting practices can lead to CU traits, while others indicate that CU traits in children may contribute to strict parenting practices (Bjørnebekk and Mørkrid thøgersen 2021). A transactional perspective is helpful in understanding this relationship, where CU traits and parenting can mutually influence each other over time (Bjørnebekk and Mørkrid thøgersen 2021).

Negative and escalating interaction patterns between children and parents, characterized by mutual coercion and tension, play a significant role in the development of behavioral difficulties (Bjørnebekk and Mørkrid thøgersen, 2021). In families with such patterns, the child's aggressive behavior is negatively reinforced, leading to a double handicap for the child: learning negative behavior and experiencing weakened social competence (Bjørnebekk and Mørkrid thøgersen, 2021). Coercive family processes seem to have a greater impact on the development of behavioral problems in children without CU traits (Bjørnebekk and Mørkrid thøgersen, 2021).

Research suggests that genetics may be the primary source of antisociality in children with high CU traits, and CU traits may adversely affect parenting practices by promoting excessively strict parenting (Bjørnebekk and Mørkrid thøgersen, 2021); however, promoting adequate parental skills and positive parenting practices towards children with high CU traits is still important. Reducing strict parenting and increasing positive involvement and affection from parents can be effective in reducing antisocial behavior in these children.

Positive parenting skills, including warm affection and the use of praise and reward, have been shown to predict the level and change in CU traits (Bjørnebekk and Mørkrid thøgersen, 2021). Interventions aimed at increasing positive parenting practices can be essential for changing CU traits and reducing antisocial behavior in these children. Observational studies have shown that adolescents with high CU traits react more with anger and irritation in interaction

tasks with their parents during conflict discussions (Bjørnebekk and Mørkrød tøgersen, 2021). Family conflicts and the quality of the parent-youth relationship are important risk factors for increased aggression in adolescents with high CU traits (Bjørnebekk and Mørkrød tøgersen, 2021). Improvements in family relationships, particularly warmth and reduction of conflicts, could positively affect the development of these young people.

Childhood abuse is a risk factor for the development of externalizing characteristics and disorders, such as antisocial personality disorder (ASPD) and psychopathy (Dargis et al., 2016). The relationship between specific types of childhood maltreatment and subsequent antisocial and psychopathic traits remains unclear. A study involving incarcerated adult male criminal offenders revealed that the severity of overall childhood maltreatment was linked to the severity of both psychopathy and ASPD in adulthood. This link was particularly strong for physical abuse and the antisocial facet of psychopathy (Dargis et al., 2016). Sexual abuse history was found to be uniquely related to juvenile conduct disorder severity rather than adult psychopathy or ASPD (Dargis et al., 2016). Additionally, there was a significantly stronger relationship between childhood maltreatment and juvenile conduct disorder compared to the relationship between childhood maltreatment and ASPD or psychopathy (Dargis et al., 2016). The findings highlight the importance of childhood maltreatment as a contributing factor to antisocial behavior later in life. The study suggests that different types of abuse may lead to specific externalizing traits and disorders in adulthood, with physical abuse being closely linked to the development of antisocial personality traits and psychopathy, while sexual abuse may be more related to juvenile conduct disorder (Dargis et al., 2016). Understanding these relationships may inform more targeted treatment and intervention efforts for individuals with a history of childhood abuse who are at risk of developing externalizing psychopathology.

The intricacies of psychopathy extend beyond observable behaviors, delving into neurocognitive disparities that reshape the moral compass of individuals with psychopathic traits. Anderson and Kiehl (2014) propose a shift in perspective, highlighting cognitive issues over behavioral aspects, challenging conventional treatment approaches that may overlook the fundamental neurological distinctions inherent in psychopathy. As previously mentioned, psychopathy presents itself with abnormal behavior, which may be a result of neurocognitive differences. These differences affect the moral compasses of psychopaths, which can entail antisocial, harmful, or dominant behavior. Anderson and Kiehl (2014) hypothesized that many behavior-focused treatments fail because psychopathy pertains to cognitive issues, rather than behavioral issues. Psychopaths cannot feel the abnormalities they experience. Rather, their brains are structured differently, resulting in dissimilar responses such as emotions and actions. Psychopaths register information aberrantly in comparison to neurotypical people, similarly to a learning disability which impairs emotional development (Kiehl and Buckholtz, 2010). Contrary to the beliefs of society, psychopaths are not purely selfish; they suffer from a consequential neurological defect (Kiehl and Buckholtz, 2010).

In 1848, Phineas Gage, a twenty-five-year-old male, experienced an extreme explosive work accident, which resulted in a metal rod, more than three feet long, blowing through the left

side of his face and out the top of his head (Kiehl and Buckholtz, 2010). Did this tragic accident result in death for Gage? No – it resulted in the acquisition of psychopathic traits. Gage lost approximately "half a teacupful" of his brain, but he never lost consciousness (Kiehl and Buckholtz, 2010). Disturbingly, Gage began to act unpredictably and impulsively, according to his coworkers (Kiehl and Buckholtz, 2010). This classic tale of neuroscience suggests that behavior like his is fundamentally biological. Following the accident, Phineas Gage was unable to use the ventromedial prefrontal cortex, similar in structure to the orbitofrontal cortex, which is believed by scientists to malfunction in psychopaths (Kiehl and Buckholtz, 2010). For context, the orbitofrontal cortex engages in complex decision-making, involving sensitivity to risk, reward, and punishment. Similarly to Gage, people with damaged orbitofrontal cortices develop impulsive behavior, often suffering from "acquired psychopathy" in addition. As both areas are related, the ventromedial prefrontal cortex receives inputs from the orbitofrontal cortex; it may benefit this field to conduct more research on the similarity between these regions (Kiehl and Buckholtz, 2010).

Although Gage was extremely transformed, he did not display all psychopathic traits such as lack of empathy, suggesting the involvement of other brain structures in the true development of psychopathy such as the amygdala, which generates emotions such as fear. Evidence suggests that one or two brain areas are too few to produce the acute impairments of psychopaths (Kiehl and Buckholtz, 2010). The tragic injury and mental impairment of Phineas Gage resulted in furthering the knowledge of psychopathy amongst scientists in psychology and neuroscience. Despite differing brain structures amongst psychopaths and non-psychopaths, because Phineas Gage shared and experienced similar traits to psychopaths, due to injury, not everyone with these traits is subjected to the mental disorder of psychopathy. Society has erroneously conflated psychopaths and individuals with psychopathic traits under a singular umbrella, despite the profound distinctions between the two.

A horseshoe-shaped band of tissue located in the brain stem, known as the paralimbic system, "may be the area that malfunctions in psychopaths" (Kiehl and Buckholtz, 2010). This system comprises numerous interconnected brain regions that detect emotions and attribute emotional significance to experiences, in addition to handling decision-making, high-level reasoning, and impulse control (Kiehl, 2006). People who face brain damage in these areas often develop psychopath traits and behavior, similar to how psychopaths often face the underdevelopment of paralimbic areas (Kiehl and Buckholtz, 2010).

#### The Cognitive and Emotional Impact of Music on Individuals with Psychopathic Traits

Due to the differences in brain structures, emotions, and behaviors within psychopaths, music affects the cognition of this group differently in comparison to the general population. Music creates a response within all people's brains, as various emotions depend on factors such as rhythm, dynamics, and major or minor keys (Trimble & Hesdorffer, 2017). When listening to enjoyable music, people frequently experience physical reactions like goosebumps or shivers down the spine, commonly referred to as "chills." These chills often indicate musical enjoyment, although not everyone experiences them in response to music (Ferreri et al., 2019). Music

triggers the pleasure centers of the brain, many of which are located in the medial forebrain bundle (MFB), releasing dopamine. Although music has the ability to influence the listener's mood, it has proven effective as treatment for conditions such as premature birth, depression, and Parkinson's disease; this is possibly due to music's association with upticks in immunity-boosting antibodies and cells which protect against bacteria and more (UAGC, 2021). Music also has the ability to impact brain development. For example, similar to how physical activity can tone muscles, training to play an instrument is a great way to increase gray matter volume in some areas of the brain. Increasing gray matter is important because it contains most of the brain's neuronal cell bodies, which are crucial for processing information, muscle control, sensory perception, memory, emotions, and decision-making. Enhanced gray matter volume is associated with better cognitive functions, improved memory, and greater learning abilities. Musicians have often reported improvement with auditory processing, learning, and memory, likely due to these increases in gray matter (UAGC, 2021).

Any music genre can produce beneficial effects in the brain. While different genres yield similar outcomes, the alignment of the listener's musical preferences with each genre can influence the results. For example, music with lively melodies and optimistic lyrics can serve as a source of energy, priming the brain for learning. Conversely, in environments that demand focused attention for learning, instrumental or calming genres may prove more effective (UAGC, 2021). Essentially, each person reacts differently to music, as everyone's brain anatomy is unique.

Classical music enhances dopamine secretion, synaptic function, learning, and memory (UAGC, 2021). In 1993, Rauscher et al. claimed that listening to Mozart's sonata for two pianos (K448) for 10 minutes improved spatial reasoning skills more significantly in normal subjects than periods of relaxation instructions designed to lower blood pressure or silence (Jenkins, 2001). The study's results, particularly the short-term impact on spatial IQ scores, have sparked controversy. For example, after listening to the sonata, the average spatial IQ scores showed an increase of 8 to 9 points compared to the scores in the other two conditions. However, it is important to note that this improvement in IQ scores was temporary, lasting only between 10 to 15 minutes (Jenkins, 2001). Certain researchers were unsuccessful in replicating the aforementioned results. However, other researchers were able to validate the notion that listening to Mozart's sonata K448 led to a slight improvement in spatial-temporal performance. This improvement was measured through various tests derived from the Stanford—Binet scale, such as tasks involving paper-cutting, folding procedures, or pencil-and-paper maze tasks. It is important to note that Rauscher emphasized the limited scope of the Mozart effect, specifically in relation to spatial-temporal reasoning, and clarified that it did not enhance general intelligence. According to her, some of the negative outcomes observed by certain researchers may have been influenced by inadequate testing methodologies (Jenkins, 2001). This research has led to the question: is the Mozart Effect a legitimate phenomenon? The initial positive findings have faced criticism regarding their generalizability. Some argue that any Mozart effect is simply a result of the enjoyable arousal caused by this specific music and would not occur without appreciation for

it. However, this interpretation has been challenged by animal experiments involving separate groups of rats. These rats were exposed to Mozart's piano sonata K448, minimalist music by composer Philip Glass, white noise, or silence during the prenatal and postnatal periods of 60 days. Subsequently, they were tested on their maze-solving abilities. The group exposed to Mozart's music performed significantly better in the maze test, completing it more quickly and with fewer errors compared to the other three groups. This suggests that the improvement observed is unlikely to be solely based on enjoyment and musical appreciation (Jenkins, 2001).

The relationship between music and spatial imaging in the brain may explain the observed effects of listening to music. Various studies using techniques like positron emission tomography (PET) and functional magnetic resonance scanning have demonstrated that music engages multiple brain areas (Jenkins, 2001). While the primary auditory area is typically located in the transverse and superior temporal gyrus, different aspects of music perception such as rhythm, pitch, meter, melody, and timbre are processed in various brain regions. These regions range from the prefrontal cortex and superior temporal gyrus to the precuneus of the parietal lobe, with interconnected networks being activated (Jenkins, 2001). Rhythm and pitch discrimination primarily occur in the left hemisphere, while timbre and melody processing are more prominent in the right hemisphere. The appreciation of meter does not show a clear preference for either hemisphere (Jenkins, 2001).

The initial experiments with adults exposed to Mozart's music had a short duration. In related studies, the long-term effects of music were investigated in preschool children (aged 3-4 years) who received six months of keyboard music lessons. During this period, they learned various musical aspects such as pitch intervals, fingering techniques, sight reading, musical notation, and playing from memory (Jenkins, 2001). By the end of the training, all children could perform simple melodies by Beethoven and Mozart. Subsequently, they underwent spatial-temporal reasoning tests, specifically designed for their age group, and their performance was more than 30% better compared to children of similar age who either received computer lessons for six months or had no special training. The improvement observed was limited to spatial-temporal reasoning and did not affect spatial recognition. The enhanced performance remained consistent for 24 hours following the completion of music lessons, although the exact duration of this enhancement was not further investigated (Jenkins, 2001). The prolonged effects were attributed to the extended exposure to music and the greater neuroplasticity of young brains. Further studies of this nature have suggested that the enhancement of spatial-temporal reasoning in children through piano training has led to significantly higher scores in advanced mathematics (Jenkins, 2001).

In conclusion of the Mozart Effect, several researchers have reported a boost in spatial-temporal reasoning performance after listening to Mozart's music for approximately 10 minutes. However, not all studies have replicated these findings, and even in the positive studies, the improvement observed is minor and lasts for approximately 12 minutes. The effect varies among individuals and depends on the specific spatial tasks employed, with no discernible impact on general intelligence. Interestingly, some patients with epilepsy have shown positive

outcomes as well. It is important to note that these results are not exclusive to Mozart's compositions, although the precise musical criteria for achieving the effect have not been fully defined (Jenkins, 2001). The practical implications of these observations remain uncertain, particularly since many experiments have focused on brief listening periods to Mozart's piano sonata K448. Further research involving longer-term exposure to Mozart and a broader range of composers is necessary to comprehensively evaluate the extent of this effect (Jenkins, 2001).

Heavy metal, a subgenre of "extreme" music, "is characterized by chaotic, loud, heavy, and powerful sounds, with emotional vocals, often containing lyrical themes of anxiety, depression, social isolation, and loneliness" (Sharman and Dingle, 2015). Due to these themes, researchers have claimed that extreme music can potentially spark anger and expression of anger, such as delinquency, drug use, and suicidal acts (Sharman and Dingle, 2015). Consequently, evidence suggests that a listener's emotional state can influence their music preferences, even when experiencing feelings of anger (Sharman and Dingle, 2015). Research on anger processing has shown that anger can activate approach motivation, which refers to the inclination to move forward and take action. As a result, when individuals experience anger, they may exhibit approach-motivated behaviors such as angry facial expressions and physical retaliation (Sharman and Dingle, 2015). Given the highly arousing nature of extreme music and the often negative themes conveyed in its lyrics, it has been proposed that extreme music elicits anger among its listeners, potentially leading to aggressive behaviors (Gowensmith and Bloom, 1997). However, an alternative perspective suggests that individuals may choose extreme music when they are already angry because the intense and arousing qualities of the music align with their existing internal arousal (Sharman and Dingle, 2015). This may allow them to explore and process their emotional state further. Sharman and Dingle's study aims to investigate these alternative hypotheses regarding the impact of extreme music listening on anger processing. It was conducted with a sample of extreme music listeners under controlled experimental conditions to shed light on this phenomenon.

Extreme music genres emerged in the early 1970s as a response to the decline of the optimistic culture of the 1960s (Stack et al., 1994) influenced by factors such as drug experimentation, societal unrest, and ongoing wars (Reddick & Beresin, 2002). Genres like punk and heavy metal embraced themes of anarchy and destruction. Over time, additional subgenres like hardcore, death metal, emo, and screamo gained prominence, characterized by powerful sounds and expressive vocals (Sharman & Dingle, 2015).

Controversy surrounds extreme music due to its aggressive lyrics and titles, which some argue can increase feelings of hostility in listeners (Sharman & Dingle, 2015). However, this effect is temporary and can be disrupted by intervening tasks (Anderson et al. 2003). Lyrical content is one mechanism linking music to emotional response, alongside other musical, contextual, and individual variables (Juslin & Västfjäll, 2008).

The powerful vocals in extreme genres like screamo, where most lyrics are screamed, contribute to the perception of anger in this music. This perception has led to stereotypes suggesting that extreme music fans, especially heavy metal fans, are more aggressive, agitated,



and aroused than the general public (Arnett, 1991; Alessi et al., 1992). Extreme music has been associated with social problems like depression, suicide, aggressive behavior, and substance misuse (Shafron and Karno, 2013). The term "problem music" has been used to describe these genres, implying an association with psychological vulnerability and social deviance (North & Hargreaves, 2006; Bodner & Bensimon, 2014; Lozon & Bensimon, 2014).

While correlational studies have linked certain music preferences to substance use, there is no evidence of a causal relationship (Sharman and Dingle, 2015). For example, a study of 7,324 Dutch adolescents found preferences for punk/hardcore, techno/hardhouse, and reggae music to be associated with substance use more, while pop and classical music were linked to substance use less in comparison when all other factors were controlled (Sharman and Dingle, 2015). "A preference for rap/hip-hop only indicated elevated smoking among girls and, interestingly, a preference for heavy metal was associated with less smoking among boys and less drinking among girls (Mulder et al., 2009)." Extreme music typically does not promote illicit drug use, and subgenres like straight edge hardcore actually advocate abstinence from drugs and alcohol (Sharman and Dingle, 2015). Additionally, there are examples of therapeutic use of rap music with individuals who misuse substances (Sharman and Dingle, 2015).

Research by Baker and Bor (2008) suggests a relationship between various music genres and antisocial behaviors, vulnerability to suicide, and drug use among young people (Sharman and Dingle, 2015). However, there is no evidence of a causal link, and music preference likely reflects emotional vulnerability in young listeners (Sharman and Dingle, 2015). Fans of "problem music" genres tend to use music for emotion regulation slightly more than fans of other genres, potentially allowing them to sublimate negative emotions rather than externalize them in antisocial acts (Sharman and Dingle, 2015).

Overall, the impact of extreme music on behaviors and emotions is complex, and further research is needed to understand the underlying mechanisms and potential implications.

## **Discussion**

In order to gain deeper insight into this intricate association, it would be valuable for future research to explore how different genres impact mood states along with behavioral patterns exhibited by those affected by pathological traits. It could be beneficial to continue research specific to this topic in order to further understand psychopathy and potentially generate new treatments or improve upon previous. Seeing as many previous treatments were unsuccessful, music therapy may prove to be effective concerning psychopaths because they share similar brain structures to non psychopaths, despite the minor differences. Further exploration will enhance our comprehension about these complexities within musical experiences' effects on mental pathology, specifically steering towards connections relating to individual genre preference range based on reported moods and subsequent behaviors amongst psychopaths.

## **Conclusion**

The relationship between music and psychopathy remains an area of limited research, but the existing evidence suggests that psychopaths may have distinct responses to different music genres due to their unique brain structures and neurocognitive differences. Psychopathy is characterized by antisocial behavior, lack of empathy, and impulsive tendencies, which can lead to harmful actions and difficulties in social relationships. The brain structures implicated in psychopathy, such as the orbitofrontal cortex and the paralimbic system, play a crucial role in emotional processing and decision-making. Music, on the other hand, has the power to influence mood, release neurotransmitters like dopamine, and impact brain development. While classical music has shown potential cognitive benefits, extreme music genres like heavy metal have been associated with anger and aggressive behavior, although the causal link remains unclear. However, it is important to note that not all psychopaths engage in criminal activity, and music preferences can vary among individuals with psychopathic traits. Future research should explore the specific effects of different music genres on the mood and behavior of psychopaths to deepen our understanding of this complex relationship.

## Works Cited

- Alessi N., Huang M., James P., Ying J., Chowhan N. (1992). "The influence of music and rock videos," in Facts for Families, Vol. 40.  
[http://www.aacap.org/App\\_Themes/AACAP/docs/facts\\_for\\_families/40\\_the\\_inf...](http://www.aacap.org/App_Themes/AACAP/docs/facts_for_families/40_the_inf...)
- Anderson, N. E., & Kiehl, K. A. (2014). Psychopathy: Developmental perspectives and their implications for treatment. *Restorative Neurology and Neuroscience*, 32(1), 103-117.  
<https://doi.org/10.3233/RNN-139001>
- Anderson C. A., Carnagey N. L., Eubanks J. (2003). Exposure to violent media: the effects of songs with violent lyrics on aggressive thoughts and feelings. *J. Pers. Soc. Psychol.* 84, 960–971.  
<https://doi.org/10.1037/0022-3514.84.5.960>.
- Arnett J. (1991). Adolescents and heavy metal music: from the mouths of metalheads. *Youth Soc.* 23, 76–98.  
<https://doi.org/10.1177/0044118X91023001004>
- Bjørnebekk, G., & Mørkrid thøgersen, D. (2021). Possible interventions for preventing the development of psychopathic traits among children and adolescents? *International Journal of Environmental Research and Public Health*, 19(1), 409.  
<https://doi.org/10.3390/ijerph19010409>
- Bodner E., Bensimon M. (2014). Problem music and its different shades over its fans. *Psychol. Music*  
<https://doi.org/10.1177/0305735614532000>
- Dargis, M., Newman, J., & Koenigs, M. (2016). Clarifying the link between childhood abuse history and psychopathic traits in adult criminal offenders. *Personality Disorders: Theory, Research, and Treatment*, 7(3), 221-228. <https://doi.org/10.1037/per0000147>
- De Brito, S. A., Forth, A. E., Baskin-sommers, A. R., Brazil, I. A., Kimonis, E. R., Pardini, D., Frick, P. J., Blair, R. J. R., & Viding, E. (2021). Psychopathy. *Nature Reviews Disease Primers*, 7(1). <https://doi.org/10.1038/s41572-021-00282-1>
- Deming, P., Heilicher, M., & Koenigs, M. (2022). How reliable are amygdala findings in psychopathy? A systematic review of MRI studies. *Neuroscience & Biobehavioral Reviews*, 142. <https://doi.org/10.1016/j.neubiorev.2022.104875>
- Ferreri, L., Mas-herrero, E., Zatorre, R. J., Ripollés, P., Gomez-andres, A., Alicart, H., Olivé, G., Marco-pallarés, J., Antonijoan, R. M., Valle, M., Riba, J., & Rodriguez-fornells, A. (2019). Dopamine modulates the reward experiences elicited by music. *Proceedings of the National Academy of Sciences*, 116(9), 3793-3798.  
<https://doi.org/10.1073/pnas.1811878116>
- Gowensmith, W. N. & Bloom, L. J. (1997). The effects of heavy metal music on arousal and anger. *J. Music Ther.* 34, 33–45. <https://doi.org/10.1093/jmt/34.1.33>
- Jenkins, J. S. (2001). The Mozart effect. *Journal of the Royal Society of Medicine*, 94(4), 170-172. <https://doi.org/10.1177/014107680109400404>

- Juslin P. N., Västfjäll D. (2008). Emotional responses to music: the need to consider underlying mechanisms. *Behav. Brain. Sci.* 31, 559–621.  
<https://doi.org/10.1017/S0140525X08005293>
- Kiehl, K. A., & Buckholtz, J. W. (2010). Inside the mind of a psychopath. *Scientific American Mind*, 21(4), 22-29. <https://doi.org/10.1038/scientificamericanmind0910-22>
- Lozon J., Bensimon M. (2014). Music misuse: a review of the personal and collective roles of “problem music”. *Aggress. Violent Behav.* 19, 207–218.  
<https://doi.org/10.1016/j.avb.2014.04.003>
- Merikangas, J. R. (2004). The development of psychopathology: Nature and nurture. *American Journal of Psychiatry*, 161(10), 1932-a-1934. <https://doi.org/10.1176/ajp.161.10.1932-a>
- North A. C., Hargreaves D. J. (2006). Problem music and self-harming. *Suicide Life Threat. Behav.* 36, 582–590.  
<https://doi.org/10.1521/suli.2006.36.5.582>
- PsychopathyIs. (2023). Psychopathy Is: We All Know Someone with Psychopathy.  
<https://psychopathyis.org/>
- Reddick B. H., Beresin E. V. (2002). Rebellious rhapsody. *Acad. Psychiatry* 26,  
<https://doi.org/10.1176/appi.ap.26.1.51>
- Shafron G. R., Karno M. P. (2013). Heavy metal music and emotional dysphoria among listeners. *Psychol. Pop. Media Cult.* 2, 74.  
<https://doi.org/10.1037/a0031722>
- Sharman, L., & Dingle, G. A. (2015). Extreme metal music and anger processing. *Frontiers in Human Neuroscience*, 9. <https://doi.org/10.3389/fnhum.2015.00272>
- Stack, S., Gundlach, J. & Reeves, J.L. (1994). The heavy metal subculture and suicide. *Suicide Life Threat Behav.*, 24(1): 15-23.
- Trimble, M., & Hesdorffer, D. (2017). Music and the brain: The neuroscience of music and musical appreciation. *BJPsych. International*, 14(2), 28-31.  
<https://doi.org/10.1192/s2056474000001720>
- UAGC Staff Member. (2021, December 8). How does music affect your brain? *Tips and Advice*.  
<https://www.uagc.edu/blog/how-does-music-affect-your-brain>

# Optimization of Tokamak Blanket Design to Minimize Neutron Flux on Magnets by Steven Benny

## Abstract

Fusion energy, a promising solution to global energy challenges, replicates the same processes that give our sun its energy, notably through deuterium-tritium (D-T) fusion reactions that produce significant energy. This study explores the mechanics and challenges of various fusion reactions, emphasizing the pivotal role of lithium breeder blankets in producing tritium, essential for sustaining D-T fusion in tokamak reactors. The helium-cooled lithium lead (LiPb) blanket design was simulated to optimize tritium breeding and neutron flux management. Results indicated a tritium breeding ratio (TBR) of 1.15, surpassing the self-sufficiency target of 1.1, with further improvements through increased lithium content and blanket thickness. Effective neutron shielding ensured safe operational limits for reactor components. These findings demonstrate the feasibility of achieving self-sustaining fusion reactions, essential for the viability of fusion power as a sustainable energy source. Future research will focus on advanced materials, refined simulations, and enhanced cooling technologies to further optimize fusion reactor designs.

## Introduction

Fusion energy stands at the front of scientific and technological innovation, offering a promising solution to the world's energy challenges. This section provides an overview of the different types of fusion reactions that replicate the energy generation process of stars, including our sun. It also dives into the critical role of lithium breeder blankets in fusion reactors and highlights the importance of tritium production for sustaining fusion reactions within Tokamak reactors.

Among the different fusion reactions present, Deuterium ( $^2H$ ) and tritium ( $^3H$ ) fusion reactions are the most promising approaches for achieving practical fusion energy. The primary reaction, ( $^2H+^3H\rightarrow^4He + n + 17.6 \text{ MeV}$ ), produces a helium-4 nucleus ( $^4He$ ) and a high-energy neutron (14.1 MeV), releasing 17.6 MeV per reaction. This reaction has the highest rate of success at achievable temperatures, making it the most practical for current fusion research. Its high energy yield and relatively low ignition temperature compared to other fusion reactions make it a very viable solution. However, challenges include the scarcity of tritium, production of radioactive neutrons, and material activation issues. (1)

Deuterium can also fuse with other deuterium nuclei through reactions such as  $^2H+^2H\rightarrow^3He + n + 3.27 \text{ MeV}$  and  $^2H+^2H\rightarrow^3He + p + 4.03 \text{ MeV}$ . These reactions produce tritium and a proton or helium-3 ( $^3H$ ) and a neutron, with a total energy release of around 4 MeV per reaction. Although the energy yield is lower than D-T fusion and requires higher temperatures for significant reaction rates, deuterium is more abundant and easier to obtain than tritium. These reactions also produce neutrons, but at a lower energy compared to D-T fusion. Nevertheless, the

higher ignition temperatures and lower reaction rates pose significant challenges for practical application. (2)

Another fusion reaction involves deuterium and helium-3, producing a helium-4 nucleus and a proton. This reaction primarily produces charged particles, resulting in minimal neutron radiation. The charged particles can be more easily converted directly into electricity, reducing radioactive waste and lowering radiation hazards. However, helium-3 is extremely rare on Earth and would need to be sourced from lunar or extraterrestrial mining or produced in other nuclear reactions. This reaction also requires even higher temperatures than D-T fusion to achieve sufficient reaction rates. More advanced technology is needed to handle the high temperatures and efficiently harness the energy produced, rendering this reaction quite impractical. (3)

While deuterium-tritium fusion offers the highest energy yield and the most practical path to fusion energy currently, other reactions involving deuterium-deuterium or deuterium-helium-3 present potential alternatives with their own advantages and significant challenges. However, this study will focus on deuterium-tritium fusion, comparing its advantages and limitations with other fusion reactions to provide a comprehensive context for its selection.

Tritium is one of the two primary fuels for deuterium-tritium (D-T) fusion reactions, which are among the most promising for achieving practical fusion energy. The D-T fusion reaction produces a significant amount of energy through the reaction. This reaction yields a helium nucleus (alpha particle) and a high-energy neutron, releasing a total of 17.6 MeV. Tritium is critical for maintaining the necessary plasma conditions, such as temperature and pressure, to sustain efficient fusion processes. (4)

Tritium is extremely rare in nature, with minimal quantities found on Earth, primarily produced through cosmic ray interactions with the atmosphere. It can also be produced in small amounts in nuclear reactors through neutron irradiation of lithium or heavy water, though these methods are limited and costly. Tritium is radioactive, emitting low-energy beta particles. While these particles are not highly penetrating, they pose a contamination risk if tritium is inhaled or ingested. Tritium's small and mobile atoms can diffuse through many materials, making containment challenging. Therefore, handling and storage of tritium are subject to stringent regulatory controls to ensure safety and environmental protection. (4)

The Tritium Breeding Ratio (TBR) is a critical parameter for fusion reactors, defined as the ratio of tritium atoms produced to tritium atoms consumed. A TBR greater than 1 indicates that the reactor produces more tritium than it consumes, essential for a self-sustaining fuel cycle. Achieving a TBR of at least 1 is crucial to ensure a continuous and adequate supply of tritium for ongoing fusion reactions. The target TBR for a self-sustaining fusion reactor is typically around 1.1 to 1.2, allowing for a margin to account for tritium losses during extraction, processing, and handling. (4)

To achieve the target TBR, the breeder blanket must be designed to maximize neutron capture by lithium and optimize the breeding reactions. This involves careful selection of materials, geometric configuration, and thermal management. Efficient heat removal systems are necessary to manage the substantial heat generated from neutron interactions and tritium

breeding reactions. Coolants such as helium or molten salts are used to transfer heat from the blanket to heat exchangers for electricity generation. The materials used in the breeder blanket must withstand high temperatures, neutron irradiation, and mechanical stresses. Advanced materials like ferritic-martensitic steels are commonly used for structural components due to their resistance to neutron-induced damage, including swelling, embrittlement, and activation. (4) For instance, ferritic-martensitic steels exhibit excellent mechanical properties and radiation resistance, making them suitable for the demanding environment of fusion reactors. Maintaining a TBR above 1 ensures that the reactor can operate continuously without requiring frequent external tritium supplies, enhancing the reactor's economic and operational viability.

Breeder blankets are essential for producing tritium, a crucial fuel for deuterium-tritium (D-T) fusion reactions in tokamak reactors. Since tritium is scarce and not naturally abundant, breeding tritium within the reactor using neutron interactions with lithium ensures a continuous and self-sufficient fuel supply. The high-energy neutrons produced in fusion reactions interact with the breeder blanket, converting their kinetic energy into heat, which is then used to generate electricity. By breeding tritium within the reactor, reliance on external tritium supplies is minimized, enhancing the sustainability and viability of fusion power. (5)

Pure lithium or lithium-based compounds are used due to their ability to breed tritium upon neutron capture. Lithium-lead alloys are often favored as they offer favorable thermal and neutronic properties, enhancing the tritium breeding ratio and overall reactor performance.

Efficient heat removal systems are necessary to manage the substantial heat generated from neutron interactions and tritium breeding reactions. Coolants such as helium or molten salts are used to transfer heat from the blanket to heat exchangers for electricity generation. (6)

The design of the breeder blanket should maximize the capture of high-energy neutrons for effective tritium breeding while minimizing neutron leakage. Efficient methods for extracting tritium from the breeder material are also essential. Techniques such as gas permeation, liquid metal extraction, and chemical processing have been employed. Neutronic simulations and experiments guide the optimization of blanket materials and geometries to achieve the desired tritium breeding ratio and overall performance. (7)

Overall, breeder blankets play a pivotal role in the production of tritium for fusion reactors, enabling a sustainable and self-sufficient fuel cycle. The integration of advanced materials and effective heat removal systems ensures the optimal performance and longevity of the reactor, paving the way for the future of fusion energy.

## **Materials and Methods**

The Monte Carlo method is a statistical approach used to model the probability of different outcomes in processes influenced by random variables. It involves random sampling to simulate complex physical and mathematical systems, making it particularly valuable for handling intricate geometries and interactions by tracking individual particle histories and tallying the results. This method finds applications across various fields, including physics, finance, engineering, and medicine.

OpenMC is an open-source code that leverages continuous-energy Monte Carlo methods to simulate neutron transport with high accuracy. It supports detailed and complex geometries, enabling precise modeling of reactor components, and is designed to run efficiently on modern parallel computing architectures, significantly speeding up simulations. OpenMC is compatible with various nuclear data libraries, such as ENDF/B, JEFF, and JENDL, ensuring accurate cross-section data for simulations. Its Python API and extensive documentation make it accessible and easy to use for researchers and engineers.

Continuous-energy Monte Carlo methods offer highly accurate results, especially for complex geometries and mixed-material systems, compared to deterministic methods. The open-source and modular design of OpenMC allows users to customize and extend the code for specific research needs. Its efficient parallel computing capabilities make it suitable for large-scale simulations required in modern fusion research. An active user and developer community contributes to the rapid development and troubleshooting, ensuring that the code remains up-to-date with the latest research advancements.

OpenMC is used to simulate the behavior and transport of neutrons within a fusion reactor, providing insights into neutron flux distribution, energy deposition, and reaction rates. It accurately models interactions between neutrons and reactor materials, essential for understanding the effects of neutron irradiation on structural materials and components. This capability is critical for designing breeder blankets, which are responsible for breeding tritium and capturing neutron energy. OpenMC helps optimize material compositions and geometries to maximize tritium breeding ratios and thermal performance.

Additionally, OpenMC is used to design and evaluate neutron shielding to protect reactor components, personnel, and the environment from harmful neutron radiation. It assists in testing and validating new materials for use in fusion reactors by simulating their behavior under neutron irradiation, helping identify materials that can withstand the harsh fusion environment. OpenMC also contributes to safety analyses by modeling potential scenarios and their impacts, ensuring that reactor designs meet safety standards and regulations. By simulating different configurations and operational parameters, OpenMC enables the optimization of reactor designs to find the most efficient and effective setups.

In this simulation, the core of the simulated tokamak consists of the plasma region where fusion reactions occur. This region is toroidal in shape, designed to confine the high-temperature plasma using magnetic fields. At the bottom of the tokamak is the divertor, which manages plasma impurities and heat. The innermost layer facing the plasma is made of materials like beryllium or tungsten to withstand high heat loads. Surrounding the first wall is the blanket, which is crucial for neutron moderation and tritium breeding. In this model, the blanket is a helium-cooled lithium lead (LiPb) blanket. The blanket, composed of a mixture of lithium and lead, serves as both a neutron multiplier and a tritium breeder. Helium gas is used to cool the blanket, chosen for its inert properties and high thermal conductivity. The blanket has channels and helium flows through these channels to remove heat.



The neutron source is distributed within the plasma region of the tokamak, emitting neutrons with a 14.1 MeV energy spectrum characteristic of D-T fusion reactions. The simulation assumes a continuous and constant source of neutrons, representing steady-state operation of the fusion reactor. Neutrons that reach the boundaries of the simulation domain are absorbed and do not re-enter, simulating an open environment around the tokamak. A structured grid is used to discretize the simulation domain for detailed spatial analysis, such as a 100x100x100 grid to ensure fine spatial resolution. This mesh covers the entire tokamak and blanket region, from the inner plasma core to the outer boundaries.

The simulation measures the neutron flux, providing information on neutron distribution within the tokamak and blanket. The tally might use a mesh filter to record flux at different points within the geometry. Additionally, it measures the rate of tritium production within the lithium lead blanket. Specific reactions are tracked to determine the breeding ratio. The tally is configured to focus on regions with lithium lead to calculate the Tritium Breeding Ratio (TBR) accurately.

The design and simulation of a tokamak involve detailed modeling of the plasma core, divertor, first wall, and blanket. Accurate simulation of neutron flux and tritium production is crucial for optimizing the reactor's performance and ensuring a self-sustaining tritium supply.

## Results

The neutron flux within the helium-cooled lithium lead blanket shows a peak value of  $1.5 \times 10^{14} \text{ n/cm}^2$  near the plasma-facing surface. This high-flux region is critical for effective tritium breeding. Moving towards the middle of the blanket, the neutron flux decreases to approximately  $8.0 \times 10^{13} \text{ n/cm}^2$ , consistent with neutron attenuation as they are moderated and absorbed by the blanket materials. Near the outer edges of the blanket, the neutron flux drops significantly to about  $3.0 \times 10^{13} \text{ n/cm}^2$ , indicative of effective neutron moderation and capture within the blanket. The design target for neutron flux within the blanket is  $1.0 \times 10^{14} \text{ n/cm}^2$ . The observed peak flux slightly exceeds this target, suggesting a robust tritium breeding environment. The blanket design aims to keep neutron flux in structural components below  $5.0 \times 10^{13} \text{ n/cm}^2$  to prevent excessive material degradation. The results indicate that the outer regions meet this safety requirement, ensuring long-term structural integrity.

The superconducting magnets are positioned outside the blanket at a radial distance of 3.5 meters from the plasma center. The neutron flux at the magnet location is measured to be  $2.5 \times 10^{11} \text{ n/cm}^2$ , which is within acceptable operational limits for superconducting materials. Long-term exposure studies suggest that neutron fluxes below  $1.0 \times 10^{12} \text{ n/cm}^2$  have minimal impact on the performance and lifespan of superconducting magnets. To further reduce neutron exposure to the magnets, additional shielding can be incorporated using high-density materials such as tungsten or boron carbide. Simulations show that adding a 30 cm thick tungsten shield can reduce neutron flux to  $1.0 \times 10^{11} \text{ n/cm}^2$ . Adjusting the thickness and material composition

of the blanket can also help in better neutron attenuation. Increasing the thickness of the lithium lead blanket by 20 cm can result in an additional 40% reduction in neutron flux reaching the magnets. Utilizing optimized magnetic field configurations can help in altering neutron paths, minimizing direct neutron streams towards the magnets.

The neutron flux distribution within the helium-cooled lithium lead blanket demonstrates effective neutron moderation and tritium breeding. The peak flux slightly exceeds design objectives but remains within safe operational limits for blanket materials. The neutron flux reaching the superconducting magnets is within acceptable levels, and further reductions can be achieved through enhanced shielding and optimized blanket design. These results ensure both the efficiency of tritium production and the longevity of critical reactor components.

The tritium breeding ratio (TBR) was calculated using reaction rates from the (n,t) reactions within the helium-cooled lithium lead (LiPb) blanket. OpenMC tallies were employed to score these reactions. The TBR is defined as the ratio of tritium atoms produced to the number of tritium atoms consumed in the D-T fusion reactions. Neutron transport simulations were run with 100,000 particles over 200 batches, ensuring statistically significant results. The reaction rates were integrated over the entire blanket volume. Moreover, the efficiency of tritium extraction methods, such as gas permeation and liquid metal extraction, was evaluated to ensure a continuous and practical supply of tritium for the reactor.

For a fusion reactor to be self-sufficient, a TBR greater than 1.0 is required. Typically, a target TBR of at least 1.1 is set to account for tritium losses in processing and handling. The calculated TBR from the current blanket design was found to be 1.15. This value exceeds the self-sufficiency target, indicating that the blanket design can produce enough tritium to sustain the fusion reactions and compensate for operational losses.

Increasing the lithium content in the blanket by 10% resulted in a TBR increase to 1.22, enhancing tritium production due to the higher availability of lithium nuclei for (n,t) reactions. Additionally, increasing the blanket thickness by 20 cm led to a TBR increase to 1.20, providing more material for neutron interaction and tritium breeding. Adding neutron reflector materials, such as beryllium, around the blanket improved neutron economy and increased the TBR to 1.18. Reflectors reduce neutron leakage and increase the probability of tritium-producing reactions.

Enhanced neutron shielding, such as adding tungsten layers, effectively reduces neutron flux to sensitive components like superconducting magnets but can also absorb neutrons that would otherwise contribute to tritium breeding. A balance must be achieved between adequate shielding and sufficient neutron availability for tritium production. For example, simulations showed that adding a 20 cm thick tungsten shield decreased the TBR to 1.10, which is still self-sufficient but closer to the threshold. Using materials with high neutron absorption cross-sections for shielding can decrease the TBR. Therefore, careful selection of shielding materials and design configurations is critical to maintaining tritium self-sufficiency.

The helium-cooled lithium lead blanket design achieved a TBR of 1.15, surpassing the self-sufficiency target of 1.1. Optimization efforts, such as increasing lithium content, blanket thickness, and incorporating neutron reflectors, further enhanced the TBR. However, these

modifications must be balanced against the need for effective neutron shielding to protect critical reactor components. By carefully managing these trade-offs, it is possible to design a fusion reactor blanket that both breeds sufficient tritium and provides necessary shielding, ensuring the reactor's overall efficiency and sustainability.

### **Conclusions and Future Frontiers**

The simulation results showed effective neutron attenuation within the helium-cooled lithium lead (LiPb) blanket, with peak neutron flux near the plasma-facing surface at  $1.5 \times 10^{14} \text{ n/cm}^2$  and significantly reduced flux at the outer regions. Neutron flux at the superconducting magnets was kept within safe operational limits at  $2.5 \times 10^{11} \text{ n/cm}^2$ . The baseline TBR achieved was 1.15, exceeding the self-sufficiency target of 1.1. Optimization strategies such as increasing lithium content, blanket thickness, and incorporating neutron reflectors further improved the TBR, with the highest increase resulting in a TBR of 1.22. The optimized blanket design proved highly effective in both neutron flux reduction and tritium breeding. Enhancements in lithium content and blanket thickness, alongside strategic use of neutron reflectors, demonstrated significant improvements in TBR without compromising neutron shielding.

These findings highlight the critical balance between tritium breeding and neutron shielding in fusion reactor design. The demonstrated TBR above self-sufficiency targets suggests that similar blanket designs could be effective in future tokamak reactors, supporting sustained fusion reactions and efficient tritium production. The neutron flux management ensures that reactor components, particularly superconducting magnets, remain within safe operational limits, enhancing the overall lifespan and reliability of the reactor. With a TBR consistently above 1.1, the blanket design shows strong potential for achieving self-sustaining fusion reactions. This is crucial for the viability of fusion power as a long-term energy source, ensuring a continuous supply of tritium for the fusion process.

Future work could involve developing more refined simulations with higher resolution and more complex geometries to identify additional optimization opportunities. Exploring combinations of different materials and configurations, such as multi-layered blankets with varying compositions, could enhance both tritium breeding and neutron shielding. Investigating new materials with superior thermal and neutron absorption properties might improve blanket performance, while exploring the use of nanostructured materials could enhance mechanical properties and radiation resistance. Research into advanced cooling technologies, such as supercritical fluids or liquid metal coolants, could improve heat removal efficiency and overall reactor performance. Developing materials that can withstand the harsh environment of a fusion reactor, including high temperatures and neutron irradiation, is essential to ensure the structural integrity and longevity of reactor components. Enhancing tritium extraction, handling, and processing technologies will also be crucial to ensure efficient and safe management of tritium produced in the reactor. Additionally, assessing the long-term economic viability and operational

challenges of the proposed design will provide a comprehensive understanding of its feasibility and potential for large-scale implementation.

### Works Cited

- Hupin, G., Quaglioni, S., & Navrátil, P. "Ab initio predictions for polarized deuterium-tritium thermonuclear fusion." *Nature Communications*, vol. 10, 2019, p. 351, doi:10.1038/s41467-018-08052-6.
- Eliezer, S., et al. "Title of the Article." *Journal Name*, vol. 40, 2000, pp. 195.
- Mahdavi, M., & Kaleji, B. "Deuterium/helium-3 fusion reactors with lithium seeding." *Plasma Physics and Controlled Fusion*, vol. 51, no. 8, 2009, pp. 085003.
- Asaoka, Yoshiyuki, et al. "Requirements of tritium breeding ratio for early fusion power reactors." *Fusion Technology*, vol. 30, no. 3P2A, 1996, pp. 853-863.
- Kuroda, T., et al. "Technical considerations on tritium breeding blanket systems for a fusion power reactor." *Fusion Engineering and Design*, vol. 8, 1989, pp. 219-226, doi:10.1016/S0920-3796(89)80110-3.
- Judd, W. C., Dutina, D., & Rodden, C. J. *Reactor Coolants*. Nuclear Materials and Equipment Corp., 1964.
- Demange, D., et al. "Tritium extraction technologies and DEMO requirements." *Fusion Engineering and Design*, vol. 109, 2016, pp. 912-916.

# The Great War's Toll: The Economic Collapse of the Ottoman Empire by Derin Değerli

## Abstract

The research paper examines the economic challenges faced by the Ottoman Empire during World War I and the policies implemented to address these issues. The war severely disrupted the Ottoman economy, exacerbating pre-existing financial difficulties. Trade embargoes imposed by the Allied Powers, coupled with increased military expenditures, led to significant budget deficits, hyperinflation, and black market activities. The conscription of the agricultural workforce resulted in reduced agricultural output, further aggravating food shortages. The government's attempts to control prices and manage subsistence supplies often backfired, encouraging smuggling and illegal trade. Despite receiving financial aid and advances from Germany and Austria, the Ottoman Empire had to resort to domestic borrowing, creating long-term debt that the state could not sustain. All of these led to the eventual demise of the six-century-old Ottoman Empire, paving the way for the establishment of the Republic of Turkey.

## Introduction

The rise of nationalism with the French Revolution and colonialism brought by the Industrial Revolution escalated international tensions. These strained relations snapped when a Serbian nationalist assassinated Archduke Franz Ferdinand of Austria-Hungary, leading to the outbreak of World War I on July 28, 1914. Despite being on the brink of economic collapse due to its geographical importance, multi-national structure, and desire for power, the Ottoman Empire's entry into this war was inevitable. Analyzing the impacts of World War I on the economy and the economic policies that the state pursued during this period is crucial for understanding the collapse of the Ottoman Empire, which had ruled for six centuries and engraved its name in history.

## Ottoman Economy Before World War I

The economy of the Ottoman Empire was deteriorating as World War I approached.

**Table-1: Gross National Income Before the War.<sup>1</sup>**

<b>GNI Based on Sectors (in terms of million kurush)</b>		
<b>Sectors</b>	<b>1913</b>	<b>1914</b>
Agriculture	10.422	15.060
Mining	156	105
Manufacturing Industry	2.551	2.443

Transportation	729	681
Trade	2.170	1.832
Financial Affairs	266	261
Government Services	1.774	1.878
Housing Incomes	664	664
Service Industry	<u>1.025</u>	<u>1.130</u>
Domestic Incomes	20.369	22.393
Remittances	<u>-103</u>	<u>-103</u>
National Income	20.266	22.393
Vehicle Taxes	<u>970</u>	<u>768</u>
Net income	21.236	23.161
Depreciation	<u>907</u>	<u>946</u>
<b>Gross National Income</b>	22.243	24.107

Despite the significant improvements in technology and economic development in the late 19th century, as seen in Table-1, the Ottoman State was still not industrialized on the eve of World War I, and its economy was based on agriculture. In addition, the Gross National Product (GNP) of the Ottoman Empire was quite low compared to other European countries.<sup>2</sup> Reforms that were carried out to keep the collapsing Ottoman economy on its feet significantly expanded the Empire's trade. Despite this expansion, the free trade agreements made along with the reforms made it difficult for local industries using human capital to compete with foreign producers who were mass producing in factories, thus making the Ottoman economy even more dependent on other countries.<sup>3</sup>

**Table-2: Trade Balance Before the War.**<sup>4</sup>

Trade Balance in the 1913/1914 Fiscal Year						
Countries	Imports	Exports	Total	Exports	Imports	Total
	(In terms of 1000 Ottoman Lira)			%		

England	8.129	4.662	12.791	19.4	21.6	20.2
Austria	6.147	2.239	8.386	14.7	10.4	13.2
France	3.592	4.295	7.887	8.6	19.9	12.4
Germany	4.689	1.234	5.923	11.2	5.7	9.3
Italy	3.639	930	4.569	8.7	4.3	7.2
Russia	3.517	831	4.348	8.4	3.9	6.8
Egypt	1.431	1.973	3.404	3.4	9.1	5.4
Romania	1.937	629	2.566	4.6	2.9	4.0
U.S.A	1.080	1.379	2.459	2.6	6.4	3.9
Belgium	1.846	539	2.385	4.4	2.5	3.8
Others	<u>5.835</u>	<u>2.889</u>	<u>8.724</u>	<u>14.0</u>	<u>13.3</u>	<u>13.8</u>
<b>Total</b>	41.842	21.600	63.442	100	100	100

As seen in Table-2, as the war approached, the imports of the Ottoman Empire were almost twice as much as its exports, significantly increasing the economic burden. Apart from the unfavorable balance of trade, the foreign debts taken also aggravated the issues of dependence on other countries and economic instability. After its first foreign debt which was taken during the Crimean War, the Ottoman Empire took foreign loans in every financial difficulty it faced. These debts were of very high amounts and their interest rates were much higher than the normal rates given to other countries.<sup>5</sup> Despite these drawbacks, the War Minister of the time, Enver Pasha, thought the war would be short and end in a few quick campaigns, so he neither made a comprehensive plan nor thought about the possible consequences of such a war. Enver Pasha lacked organizational skills, did not understand logistics, and did not have the patience to manage the state, thus recklessly plunging the Ottoman State into chaos.<sup>6</sup> Referred to as the “sick man” on the brink of war, the Ottoman Empire was seeking a cure for his illness. In this context, to regain its lost territories and to get rid of the capitulations and foreign debts, the Empire entered the war alongside Germany as a Central Power. From a financial point of view, entering World War I with such an economy was both impossible and necessary.<sup>7</sup>

### **Ottoman Economy during World War I Trade**



The Ottoman Empire's growing trade has changed significantly when the World War I broke out. With this change, Ottoman Empire's trading relations with other countries was reshaped.

**Table-3: Impact of War on Trade Relations.**<sup>8</sup>

Ottoman Trade Distribution Amongst Different Countries				
	1913/1914		1916/1917	
Countries	Imports	Exports	Imports	Exports
	%	%	%	%
Germany	11.2	5.7	35.7	73.1
Austria	14.7	10.4	55.5	22.3
England	19.4	21.6	-	-
France	8.6	19.9	-	-
Italy	8.7	4.3	-	-
Russia	8.4	3.9	-	-
Romania	4.6	2.9		
Bulgaria	0.6	1.2	5.0	4.6
Others	23.8	30.1	1.3	5.0

As can be seen in Table 3, the Ottoman Empire's trade relations with the Allies -such as England and France- were cut off, and instead, the trade relations with the Central Powers -such as Germany and Austria- were strengthened.

**Table-4: Trade Balance During War.**<sup>9</sup>

Trade Balance in Different Years of War		
Fiscal Years	Imports	Exports
	(In terms of Million Ottoman Liras)	
1913/14	41.84	21.60

1914/15	23.60	14.65
1915/16	4.3	4.9
1916/17	10.2	12.3
1917/18	15.08	13.98
1918/19	21.28	14.89

Due to the embargoes on the Ottoman Economy at the climax of the war (1915/1916), the imports of the empire were reduced to one tenth of their previous size and exports were reduced to one fifth. Not only was the empire importing machinery and war equipments, but they were also importing nutritions to financially support rural areas of the empire.<sup>10</sup> Therefore, these embargoes affected the standards of living as well as the military and production.

### **Budget, Inflation and Blackmarkets**

As seen in Table-5, with the beginning of World War I, war expenses and hence total expenses increased. During the time span from 1913 to 1918, war expenses rose from 2.7 to 79.2, nearly 30 times, and total expenses increased from 35.3 to 122.5, nearly 4 times.

**Table-5: Change in the Budget During the War.**<sup>11</sup>

The Ottoman Empire's War Budget						
Years	Debt Servicing	Wages	General Expenses	Investments	War Expenses	Total
(In terms of Million Ottoman Liras)						
1913/14	13.0	11.3	6.2	2.1	2.7	35.3
1914/15	13.8	11.3	6.8	1.5	24.4	57.8
1915/16	15.6	12.0	6.9	0.7	30.5	65.5
1916/17	15.8	13.3	7.6	0.6	45.7	83.0
1917/18	17.2	13.4	8.5	1.0	68.9	109.0
1918/19	17.4	15.0	9.8	1.1	79.2	122.5

The military expenses and costs incurred were due to the increased demand for equipment, food, clothing, and similar products to be used by soldiers. In addition, the embargoes imposed by the Allied Powers on Ottoman foreign trade reduced the total supply in the Ottoman Empire.<sup>12</sup> The increased total demand and decreased total supply led to hyperinflation. The inflation rate during the period from the beginning to the end of World War I was 2500%.<sup>13</sup> Hyperinflation raised average price levels, which led to the depreciation of Ottoman currency, meaning a decrease in purchasing power. When purchasing power decreased, problems with meeting fundamental needs began to arise among the population. Farmers, aiming to take advantage of these subsistence problems, reported lower than the actual harvests in their records and started selling the unreported harvests at high prices on the black markets.<sup>14</sup> In addition to the sale of harvests on the black market, hoarding, warehousing, and gold smuggling would also become commonplace in the near future.<sup>15</sup>

**Agriculture**

Since the Ottoman Empire did not industrialize, agriculture relied on human labor. When World War I broke out, 80% of those recruited in the army were either directly or indirectly contributing to agriculture.<sup>16</sup> Anticipating a decline in harvests during the war, the government started subsidizing the agriculture sector before the war even began, and hence, harvests started to increase.<sup>17</sup> In 1914, compared to the previous year, agricultural production increased by an average of about 13%, but during the war years, the sector decreased by approximately 30% each year.<sup>18</sup>

**Industry**

Before the war began, the Ottoman industry relied on foreign establishments, but the embargoes brought by the war led to the growth of local establishments.<sup>19</sup> Free from external competition, local establishments expanded their areas of operation and discovered new manufacturing methods. With decreased competition, cost issues also diminished for the domestic industry, but challenges such as raw material shortages and difficulties in finding workers arose.<sup>20</sup> Although the number of establishments increased due to reduced external competition, many factories had to cease operations due to the lack of raw materials. This situation can be observed in Table-6.

**Table-6: Industry During War.**<sup>21</sup>

Different Ottoman Industries During War			
Industry	Number of Businesses	Number of Workers	Production value

	Present		Active				(Million kurush)	
	1913	1915	1913	1915	1913	1915	1913	1915
Nutrition	74	75	71	57	4.281	3.916	456.6	531.9
Soil	16	17	16	5	980	336	13.4	2.7
Tanning	12	13	11	12	930	1.270	32.0	62.6
Wood	19	24	19	19	705	377	11.1	5.9
Textile	70	73	61	36	7.667	6.660	100.3	90.8
Paper	51	51	51	49	1.897	1.267	37.5	46.2
Chemistry	10	11	10	4	417	131	16.9	17.0
<b>Total</b>	252	264	229	182	16.975	14.060	670.8	757.0

## Ottoman Empire's Economics Policies During World War I

### Taxes

One of the primary policies the Ottoman Empire resorted to for financing the war was taxation. There were three types of taxes is the Ottoman Empire aimed at financing the war: the Dividend Tax, the War Tax, and the Ashar Tax. The Dividend Tax involved taxing the earnings of individuals engaged in commerce, arts, and crafts. Although this tax was first implemented in 1907, it was abolished due to its ineffectiveness and then reintroduced in 1914.<sup>22</sup> The War Tax was implemented in 1912 to facilitate covering war expenses but was abolished in 1920 due to its inefficiency.<sup>23</sup> The Ashar Tax was a tax on the harvested crops. While the percentage of this tax was not increased, its collection became more difficult due to the scarcity brought by the war. Consequently, a law enacted in 1914 decreed that for villages where auction or administration was not possible, the average amount of ashar for the years 1911, 1912, and 1913 would be paid at the end of the war.<sup>24</sup> At the beginning of the war, the Ottoman Empire was able to slightly alleviate its budgetary burden through tax applications. However, as the war progressed and subsistence problems increased, tax collectors, especially in rural areas, encountered significant resistance while trying to collect tax revenues.<sup>25</sup> With this resistance, the taxation system began to lose its effectiveness, public order deteriorated, and a conflict emerged between the state and the people.

### Subsistence Problems

Subsistence refers to the provision of food and drink, nourishment, and care, essentially meeting basic needs. During World War I, alongside the army's increasing basic needs, the population's subsistence problems also grew. Anticipating these scarcity problems, a series of measures were taken even before the war began. Within this framework, a decision on July 24, 1914, halted the export of nutrients and livestock, and a commission was established to manage subsistence affairs. This aimed to prevent the public from experiencing shortages problems and to curb potential price increases. The subsistence policies particularly focused on meeting the population's need for wheat and bread. In this context, it was decided that bakeries requisitioned for military needs would continue to supply bread to the public with ration cards.<sup>26</sup>

Although the intentions behind the state's subsistence policy were beneficial, its interventions and controls in economic life, particularly regarding prices, often made securing subsistence even more challenging. Keeping prices low to protect consumers encouraged smuggling and led traders to supply goods to other markets.<sup>27</sup>

### **Credits, Advance Payments, Loans, and Borrowing**

In October 1914, Germany offered the Ottoman Empire an advance payment of 5 million liras in gold on the condition that it entered the war on the side of the Central Powers. When the Finance Minister of the time, Cavid Bey, hesitated to work with Germany, the Germans improved the terms of the agreement. In the following months, the Ottoman Empire frequently received credits from Germany and Austria and joined the war on the side of the Central Powers in February 1915.<sup>28</sup> The advances received from Germany and the corresponding issuance of paper money can be seen in Table-7.

**Table-7: Credits Taken During War.**<sup>29</sup>

<b>Credits</b>	
<b>Year</b>	<b>Lira</b>
1914	5.000.000
1915 I	4.346.093
1915 II	8.000.000
1915 III	11.700.400
1916 I	32.000.000
1916 II	35.981.400

1916 III	6.000.000
1917 I	50.000.000
1917 II	3.500.000
1918	24.000.000
<b>Total</b>	180.527.893

The credits successfully alleviated the economic burden on the Ottoman Empire; however, as the war dragged on in its later years and hopes for victory diminished, the Germans became more reluctant to provide advances. Consequently, the Ottoman Empire resorted to domestic borrowing for the first time. In this context, a law enacted on April 3, 1918, designed a long-term borrowing policy with a 5% interest rate and a 20-year maturity.<sup>30</sup> The borrowing policy had both positive and negative aspects. On the positive side, the state could quickly generate income and thus mitigate its economic burden on a short notice according to the developments in the war. However, the long-term implications and potential challenges of the borrowing policy were also significant concerns. However, it led to the state borrowing from the public, creating domestic debt. The borrowing policy planned for the full repayment of the money after 20 years, but the Ottoman Empire collapsed four years after this policy was implemented. Therefore, when it was in effect, the positive impacts of the borrowing policy outweighed the negative effects for the Empire, but the contrary can be said for the people of the Empire.

## **Conclusion**

Due to various reasons, primarily economic difficulties, the Ottoman Empire was forced to enter World War I. The war immensely affected the Ottoman economy mostly in a negative way. The Allied Powers imposed trade embargoes, severing commercial relations with these nations. The burden on the budget significantly increased due to debts, the growing demands of the army, and decreased supply, which created hyperinflation and subsistence problems, resulted in black market activities. The conscription of the agricultural population led to a decline in agricultural production and crop harvests. The reduction in foreign trade decreased competition among industrial establishments, but a considerable number of establishments became non-operational due to the raw material shortages caused by the decline in foreign trade.

To mitigate these repercussions, numerous economic policies were implemented. However, these policies mostly failed to achieve their intended goals. Although the taxes imposed by the state were initially effective, the increasing subsistence problems over time made tax collection difficult. The state's interventions in the economy -mostly price controls- encouraged various crimes including black market activities. While the advances received and the borrowing policy adopted helped alleviate the economic burden on the budget, they also led to external and internal debt.

The adverse effects of World War I on the economy, combined with the inadequacy and inefficiency of the government's policies during this period, directly contributed to the collapse of the six-century-old Ottoman Empire and the subsequent establishment of the Republic of Turkey, which prevails today.

## Works Cited

- Bostancı, Emir, Exemption Status and Application in War Gains Tax, Atatürk Research Center Journal, 2019.
- Eldem, Vedat, The Economy of the Ottoman Empire during the War and Post-War Years, Volume 7, Turkish Historical Society Publications, Ankara, 1994, p. 6.
- Eldem, Vedat, The Economy of the Ottoman Empire during the War and Post-War Years, Volume 7, Turkish Historical Society Publications, Ankara, 1994, p. 17.
- Eldem, Vedat, The Economy of the Ottoman Empire during the War and Post-War Years, Volume 7, Turkish Historical Society Publications, Ankara, 1994, pp. 68.
- Eldem, Vedat, The Economy of the Ottoman Empire during the War and Post-War Years, Volume 7, Turkish Historical Society Publications, Ankara, 1994, pp. 66.
- Eldem, Vedat, The Economy of the Ottoman Empire during the War and Post-War Years, Volume 7, Turkish Historical Society Publications, Ankara, 1994, p. 95.=
- Eldem, Vedat, The Economy of the Ottoman Empire during the War and Post-War Years, Volume 7, Turkish Historical Society Publications, Ankara, 1994, pp. 33.
- Eldem, Vedat, The Economy of the Ottoman Empire during the War and Post-War Years, Volume 7, Turkish Historical Society Publications, Ankara, 1994, pp. 37.
- Eldem, Vedat, The Economy of the Ottoman Empire during the War and Post-War Years, Volume 7, Turkish Historical Society Publications, Ankara, 1994, pp. 34.
- Eldem, Vedat, The Economy of the Ottoman Empire during the War and Post-War Years, Volume 7, Turkish Historical Society Publications, Ankara, 1994, pp. 75.
- Eldem, Vedat, The Economy of the Ottoman Empire during the War and Post-War Years, Volume 7, Turkish Historical Society Publications, Ankara, 1994, pp. 76.
- Eldem, Vedat, The Economy of the Ottoman Empire during the War and Post-War Years, Volume 7, Turkish Historical Society Publications, Ankara, 1994, pp. 86.
- Eldem, Vedat, The Economy of the Ottoman Empire during the War and Post-War Years, Volume 7, Turkish Historical Society Publications, Ankara, 1994, p. 89.
- Eldem, Vedat, The Economy of the Ottoman Empire during the War and Post-War Years, Volume 7, Turkish Historical Society Publications, Ankara, 1994, p. 111.
- Eldem, Vedat, The Economy of the Ottoman Empire during the War and Post-War Years, Volume 7, Turkish Historical Society Publications, Ankara, 1994, p. 110.
- Fromkin, David, A Peace to End All Peace: The Fall of the Ottoman Empire and the Creation of the Modern Middle East, New York, 2009, p. 122.
- Gratz, G. and Schüller, R. (1928), The Economic Policy of Austria-Hungary During the War, Carnegie Endowment for International Peace, New Haven, CT: Yale University Press.
- Gümüş, Öner, Disaster in Public Finance: Moratorium during the DP Period, Volume 22, Dergipark, 2023.
- Korkmaz, Erdal, Black Market in the Ottoman State During World War I, Dergipark, Issue 66, 2020.



- Korkmaz, Erdal, Black Market in the Ottoman State During World War I, Dergipark, Issue 66, 2020.
- Ozavcı, Ozan, War Finance (Ottoman Empire), Version 1, 1914-1918 Online: International Encyclopedia of the First World War, 2017.
- Ozavcı, Ozan, War Finance (Ottoman Empire), Version 1, 1914-1918 Online: International Encyclopedia of the First World War, 2017.
- Ozavcı, Ozan, War Finance (Ottoman Empire), Version 1, 1914-1918 Online: International Encyclopedia of the First World War, 2017.
- Pamuk, Şevket, The Ottoman Economy in World War 1, Volume 1, Cambridge University Press, Cambridge, 2009, p. 112.
- Pamuk, Şevket, The Ottoman Economy in World War 1, Volume 1, Cambridge University Press, Cambridge, 2009, p. 113.
- Pamuk, Şevket, The Ottoman Economy in World War 1, Volume 1, Cambridge University Press, Cambridge, 2009, p. 145.
- Pamuk, Şevket, The Ottoman Economy in World War 1, Volume 1, Cambridge University Press, Cambridge, 2009, p. 118.
- Tüzün, Nevim, Interpreter of Internal Borrowing During World War I, Truth, Reflections in Sabah and Vakit Newspapers, Kesit Academy Journal, 2019.
- Uzun, Ahmet, Urban Economy and Subsistence in the Ottoman State, Turkish Studies Literature Journal, 2005.
- Vergeot, Jean, THE PAPER-MONEY IN TURKEY DURING THE WAR, Volume 33, JSTOR, 1919.

## **Mental Health Impacts of COVID-19 During the 2020-2021 Pandemic by Purvi Kumar**

### **Introduction**

The outbreak of the COVID-19 pandemic in 2020 brought about unprecedented challenges that permeated every aspect of society. It profoundly impacted the mental well-being of individuals across communities in the United States as the nation grappled with the physical health implications of the virus and the psychological toll of prolonged isolation, fear, uncertainty and grief. Understanding the mental health implications of the pandemic on groups of different class, occupation, and race is essential for formulating effective intervention strategies and support systems. The sudden and drastic change that accompanied the emergence of the virus including widespread lockdowns, social distancing mandates, and a pervasive atmosphere of fear and uncertainty created a unique and highly stressful environment for communities. The rapid shift to remote work, closure of schools and businesses, and limitations on social interactions disrupted established routines and social support systems, leading to the high levels of anxiety and emotional distress among the population.

In particular, the immediate impact on first responders (e.g., doctors, EMTs) who were thrust onto the front lines of the public health crisis was profound and deeply challenging. These essential workers faced unique circumstances, including a surge in hospitalizations, shortages of personal protective equipment, and continuous exposure to traumatic and emotionally demanding situations. Within the broader population, the effects of the pandemic on mental health were widespread. The prevalent fear of contracting the virus, coupled with concerns about economic stability, job loss, and social isolation, created a dilemma of stressors that impacted individuals of all ages, backgrounds, and socioeconomic statuses. The disruption to social connections, uncertainty about the future, and the loss of familiar coping mechanisms contributed to a collective sense of distress that reverberated throughout communities nationwide.

This literature review explores the broad mental health impacts of the COVID-19 pandemic on diverse communities in the United States between 2020 to 2021. This review aims to highlight the unique challenges faced by vulnerable populations, healthcare workers, students, teachers, business owners, the elderly, and homeless individuals. Additionally, it seeks to identify the specific needs of these communities in order to inform targeted support services addressing the mental health concerns amidst the ongoing crisis.

### **Teachers**

Looking into the mental impacts of the pandemic on teachers offers valuable insights into the broader societal repercussions of this unprecedented crisis and underscores the urgent need for comprehensive support and resources to address the mental health needs of educators and safeguard the resilience of the education system. The pandemic created a mental toll on educators, particularly in relation to the stress of adapting to new teaching methods, concerns about pay, and the challenges of managing

classes virtually. As schools rapidly transitioned to remote or hybrid learning models, teachers faced unprecedented pressure leading to clinical levels of anxiety and the development of generalized anxiety disorder (GAD). Studies examining the prevalence of anxiety symptoms found that 38.4% to 73% of teachers met criteria for GAD. (Ala'a et al., 2020 and Lizana & Lera, 2022)) Prevalence in these studies To innovate teachers instructional approaches while grappling with the emotional strain of navigating the uncertainties brought about by the pandemic. Research indicates that educators in New Orleans charter schools (81% women; 55% Black) on average experienced 7 stressors out of 18 surveyed (list some examples here from the study) and 4 protective factors (e.g., support groups, success) of the 6 surveyed (Baker et al., 2021). Teachers that were more highly stressed reported worse mental health. Those who reported having more protective factors were more likely to find it easier to cope with the pandemic. There were also differences based on the racial identity of the teacher, such that black teachers were reported to have better mental health, and teachers overall talked about lack of connection with coworkers which lifted stress off of teachers. (Baker et al., 2021).

Moreover, the issue of teacher compensation also emerged as a critical concern, with educators voicing frustration over stagnant wages, increased workloads, and the lack of recognition for their essential role in maintaining continuity in education during the crisis. The financial strain exacerbated existing disparities in pay within the profession and intensifying feelings of undervaluation and burnout among teachers. Additionally, managing classes virtually presented significant logistical challenges, further contributing to educators' mental health burdens. As teachers navigated technological barriers, student engagement issues, and the absence of in-person interaction, many reported feelings of isolation, exhaustion, and diminished job satisfaction. (Pokhrel et al.,2021)

## **Students**

There was a profound psychological toll on college and high school students during the crisis and schools may have overlooked the urgent need for student support systems to address the diverse and complex needs of young people in the aftermath of the pandemic. It unveiled a multitude of challenges faced by students, ranging from decreased socialization and loss of community to learning difficulties and stress from parents ( Wood et al., 2022). A study conducted by Wood and colleagues (2022) demonstrated that 81.6% of students self-reported at least one negative mental health problem. Students were also reported to have an 8% increase in feelings of hopelessness, +7% feelings of loneliness, +9% feelings of sadness, +3% depression, and +15% feelings of anger during the pandemic. With the abrupt shift to remote learning and social distancing measures, students grappled with the profound disruption of their social lives and routines. The absence of in-person interaction deprived many of the vital connections and support systems provided by school communities, leading to feelings of isolation and loneliness among students of all ages. Moreover, the loss of milestone events such as high school or college graduations compounded the sense of disappointment and disillusionment, depriving students of the closure and celebration they had anticipated. The transition to virtual learning also

exacerbated learning difficulties for many students, particularly those from disadvantaged backgrounds or with special needs, who faced increased barriers to accessing educational resources and support. Additionally, the stress from parents navigating their own challenges during the pandemic further strained students' mental well-being, as they grappled with academic pressures, familial tensions, and the uncertainty of the future.

## **Parents**

Examining the mental impacts of the pandemic on parents offers critical insights into the broader societal repercussions of this novel crisis and underscores the urgent need for comprehensive support systems to address the diverse and complex needs of caregivers in the aftermath of the pandemic. The notable challenges faced by parents were overlooked. These challenges include working from home while managing children's schooling, navigating childcare options, concerns about vaccines for young children, and the overarching stress, fear, and uncertainty surrounding vaccine protection (Alonzo et al., 2022). With the widespread implementation of remote work arrangements and school closures, many parents found themselves juggling professional responsibilities alongside the demands of supervising their children's education at home. This balancing act not only strained parental productivity but also exacerbated feelings of burnout and exhaustion as parents grappled with the constant juggling of competing priorities as well as kids. Since March 2020, 27% of parents reported declining mental health and 14% reported worsening behavioral health for their kids (Patrick et al., 2020). For parents with newborns, the challenges were particularly acute, as they navigated the complexities of caring for a vulnerable infant amidst a global health crisis. Additionally, the risks associated with daycare facilities became a source of heightened anxiety for many parents, who weighed the benefits of childcare against the potential exposure to the virus. Concerns about vaccine efficacy and safety for young children further compounded parental stress, as caregivers wrestled with the uncertainty surrounding their children's health and well-being. The pervasive sense of fear and uncertainty surrounding vaccine protection underscored the profound psychological toll of the pandemic on parents as they navigated the complexities of safeguarding their family's health in an uncertain and rapidly evolving landscape. Male parents had the struggle of keeping a good income coming in as female parents had to deal with the children at home and stress over how to manage kids all day everyday for as long as they were told. Therefore, it can't be overlooked that both parents faced stressors along with their kids.

## **Healthcare Works**

The plight of healthcare workers during the COVID 19 pandemic cannot be overstated. This community represents one with major unmet needs in support. Healthcare workers, faced with an exponential increase in patient numbers, had to bear the weight of the crisis, grappling with the dual burden of caring for the sick while confronting the risk of falling ill themselves. The sheer volume of cases led to a state of perpetual overwork, heightening an already dire situation. As the pandemic raged on, the toll on healthcare workers only intensified, with

mounting pressure and exhaustion becoming their daily reality. The main stressors amongst healthcare workers were infection of colleagues (72.5%), stress of family members (63.9%), and lack of protective measures (52.3%) 40% of Healthcare workers worried about self-infection (Birhanu, Gebrekidan, and Tesefa, 2018). Additionally, mental health was likely impacted by healthcare workers regularly seeing patients die and worrying about infecting their families. It was understood that workers felt helpless in treating patients as society didn't have a great idea of the illness or what treatments would help. This fast surge in workload has highlighted not only the physical demands but also the profound mental impacts of the crisis, underscoring the urgent need for comprehensive support systems to safeguard the well being of those who tirelessly serve our communities.

### **Elderly**

Throughout the long era of the pandemic, the elderly population has emerged as one of the most vulnerable demographics (add a statistic), confronting a myriad of challenges that have significantly impacted their mental well being. With advanced age comes a higher likelihood of severe outcomes from the virus, aggravating fears and anxieties among the elderly community. The prevalence of communal living arrangements, such as nursing homes and assisted living facilities, has only served to compound their risk of sickness, as these environments often facilitate the spread of infectious diseases. Moreover, stringent safety measures implemented to mitigate transmission have resulted in the heartbreaking reality of elderly individuals being isolated from their families, deprived of the comforting presence of their loved ones during times of crisis. The profound sense of loneliness and isolation has resulted in increased rates of depression and is overlooked when it comes to interventions that address mental health challenges faced by this vulnerable community. Bailey and colleagues (2021) conducted a study examining elderly individuals who were cocooning in a facility during the pandemic. This resulted in them staying in their homes and rarely being outdoors, which most likely led to many self reported trends (see figure 1).

**Figure 1.** Self-reported trends in QOL, physical and mental health while cocooning. Notes: n = 150. Abbreviations: QOL, ...

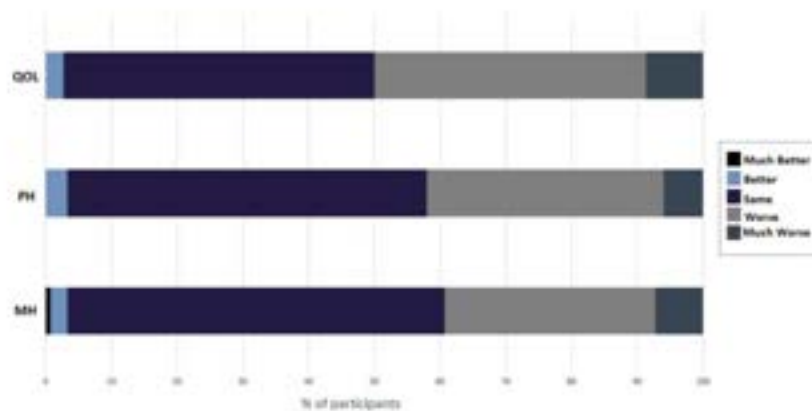

*QJM*, Volume 114, Issue 9, September 2021, Pages 648–653, <https://doi.org/10.1093/qjmed/hcab015>  
 The content of this slide may be subject to copyright please see the slide notes for details.



Figure 1. Self reported trends in QOL, physical and mental health while cocooning. Participants were asked questions: 1) How has your Quality of life (QOL) changed while cocooning? 2) Compared to before the pandemic, how would you say your physical health was while cocooning? 3) Compared to before the pandemic, how would you say your mental health was while cocooning? (Bailey, et al., 2021)

### Homeless Individuals

As the pandemic continues to harm communities, the mental toll on homeless individuals is understudied despite the high rates of mental and physical health problems amongst homeless individuals. Even before the pandemic, homeless individuals have not been cared for as they are low on the social scale, which leads to gaping disparities in access to basic necessities and healthcare. With shelters stepping in to provide essential resources such as food and water, homeless populations have found a lifeline amidst the chaos, although they are faced with challenges. The lack of access to vaccines and masks left this already vulnerable group at a disadvantage, perpetuating their rates of infection and amplifying feelings of helplessness and insecurity (Martinet al., 2021). Moreover, the closure of public spaces, often a refuge to those without shelter, has further compounded their sense of isolation and displacement, stripping away even the semblance of stability and routine. Martin and colleagues (2021) found that

psychological disorders are present in approximately 50% of homeless people with a prevalence of 35% for mental disorders. One solution to these concerns was the Red Cross and Catholic charities allowed homeless people to use the city's municipal shelter.

### **Business Owners**

In the height of the pandemic, business owners, particularly those who were involved in the fields of hospitality and retail sectors such as restaurants, malls, and stores, encountered an array of obstacles. Amidst strict regulations and safety protocols disrupting their usual operations, these entrepreneurs found themselves grappling with a significant decline in revenue. Business sales dropped 17% during the second quarter of the pandemic in 2020 in California (citation). Accommodations (e.g., hotels) lost 91% of sales (Fairlie & Fossen, 2021). Business owners faced the mental health impacts of keeping their business afloat and maintaining their income. The dreams and aspirations they invested in their ventures faced an economic downturn. Once vibrant hubs of activity, these commercial spaces now stand quiet, serving as a symbol of the economic hardships faced by the owners of those businesses. As financial worries mounted on top of the owners they had feelings of uncertainty, stress, anxiety, and a deep sense of loss. These weighed heavily on the minds of the business owners taking a significant toll on their mental health.

### **Implications for Support and Intervention**

Communities during the pandemic had to bear different mental health impacts that may have led to lasting consequences in their well being. This review suggests that there were notable gaps in support for the homeless and elderly. Future research should focus on how to provide ways for mental health support for vulnerable communities with limited access to mental health resources. Different communities also faced unique stress factors. Teachers and students both had the stress of the education factors such as keeping up with assignments, maintaining grades, and assignment planning all virtually. Not only does education come into play, but social factors do as well. Social isolation from lack of in person interaction and missing big events that happen in school can impact mental health. Parents have to deal with their kids' activities and vaccines which is a whole weight on their shoulders as they are tackling the adjustment to the pandemic as well. Healthcare workers play a big role in the pandemic as they are the ones risking their health to help others, providing vaccines, and adjusting to the changes of the pandemic while doing all of that. The elderly and homeless people have the stress of not having family and top medical care as they live in public facilities. Business owners have a stress of money because as the pandemic shut everything down income is at a huge loss as not many interactions to businesses occurred. As stated, the communities suffer a variety of stresses where help should be provided as these communities face a sense of loss. Support solutions that could be given to these communities are things such as, support groups, for the homeless, elderly and parents. There could be fundraisers for business owners that loss large amounts of income. For students and teachers a support that could be given is counselor sessions in school for free.

## **Conclusion**

The outbreak of the COVID-19 pandemic in 2020 brought a massive change on society and caused serious mental health challenges. The start of the pandemic showcased the immediate need to start implementing precautions and procedures. The rapid change in how schools, businesses, and society as a whole changed caused a significant toll on the mental well being of members in the communities. Each community faced mental health impacts and profound challenges as they coped with these changes. The fear of contracting the virus, paired with concerns about economic stability, job loss, and social isolation, created a dilemma of stressors that impacted individuals of all ages, backgrounds, and socioeconomic statuses. The disruption to social connections, uncertainty about the future and the loss of familiar coping mechanisms contributed to a collective sense of distress and unease reverberated throughout communities nationwide. Interventions are important for the future of society's mental health whether people still deal with it or not.



## Works Cited

- Akour, A., Ala'a, B., Barakat, M., Kanj, R., Fakhouri, H. N., Malkawi, A., & Musleh, G. (2020). The impact of the COVID-19 pandemic and emergency distance teaching on the psychological status of university teachers: a cross-sectional study in Jordan. *The American journal of tropical medicine and hygiene*, 103(6), 2391.
- Alonzo, D., Popescu, M., & Zubaroglu Ioannides, P. (2022). Mental health impact of the Covid-19 pandemic on parents in high-risk, low income communities. *International Journal of Social Psychiatry*, 68(3), 575-581.
- Bailey, L., Ward, M., DiCosimo, A., Baunta, S., Cunningham, C., Romero-Ortuno, R., ... & Briggs, R. (2021). Physical and mental health of older people while cocooning during the COVID-19 pandemic. *QJM: An International Journal of Medicine*, 114(9), 648-653.
- Baker, C. N., Peele, H., Daniels, M., Saybe, M., Whalen, K., Overstreet, S., & The New Orleans, T. I. S. L. C. (2021). The experience of COVID-19 and its impact on teachers' mental health, coping, and teaching. *School Psychology Review*, 50(4), 491-504.
- Birhanu, M., Gebrekidan, B., Tesefa, G., & Tareke, M. (2018). Workload Determines Workplace Stress among Health Professionals Working in Felege-Hiwot Referral Hospital, Bahir Dar, Northwest Ethiopia. *Journal of environmental and public health*, 2018.
- Fairlie, R., & Fossen, F. M. (2021). The early impacts of the COVID-19 pandemic on business sales. *Small Business Economics*, 1-12.
- Lizana, P. A., & Lera, L. (2022). Depression, anxiety, and stress among teachers during the second COVID-19 wave. *International journal of environmental research and public health*, 19(10), 5968.
- Martin, C., Andrés, P., Bullón, A., Villegas, J. L., de la Iglesia-Larrad, J. I., Bote, B., ... & Roncero, C. (2021). COVID pandemic as an opportunity for improving mental health treatments of the homeless people. *International Journal of Social Psychiatry*, 67(4), 335-343.
- Patrick, S. W., Henkhaus, L. E., Zickafoose, J. S., Lovell, K., Halvorson, A., Loch, S., ... & Davis, M. M. (2020). Well-being of parents and children during the COVID-19 pandemic: a national survey. *Pediatrics*, 146(4).
- Pokhrel, S., & Chhetri, R. (2021). A literature review on impact of COVID-19 pandemic on teaching and learning. *Higher education for the future*, 8(1), 133-141.
- Wood, C. I., Yu, Z., Sealy, D. A., Moss, I., Zigbuo-Wenzler, E., McFadden, C., ... & Brace, A. M. (2022). Mental health impacts of the COVID-19 pandemic on college students. *Journal of American college health*, 1-6.

# **A Literature Review Of How Monoclonal Antibodies Treat Lesional Skin In Atopic Dermatitis And A Proposal Of An Anti-inflammatory Therapy Approach Targeting CCL22's Binding To CCR4 By Aisha Weththasingha**

## **Abstract**

Inflammation and lesional skin in patients with atopic dermatitis results from an inflammatory pathway and chemotactic signaling. Inflammation is stimulated by T helper 2 (Th2) cells, a type of T lymphocyte, that produce and activate certain cytokines. Inflammation is further developed and intensified by the presence of chemokines such as C-C motif chemokine ligand 22 (CCL22) and C-C motif chemokine ligand 17 (CCL17) binding to their receptor, C-C motif chemokine receptor 4 (CCR4). Once bound, these chemokines direct inflammatory cytokines to existing sites of inflammation, further developing and intensifying inflammation and lesional skin.

Current treatments using monoclonal antibodies include dupilumab and tralokinumab, both of which target interleukins. They have both shown to be effective as targeted therapies but still fall short in a few specific areas. CCR4 inhibition has been examined and used to create other monoclonal antibodies such as mogamulizumab. Mogamulizumab is a monoclonal antibody that targets CCR4 and prevents inflammation in another inflammatory disease. It has proven effective in its design. Several other monoclonal antibodies have also been designed to target CCR4 to treat inflammation in other inflammatory diseases in addition to atopic dermatitis. They have proven to be efficient in relieving inflammation or inflammatory responses.

Since the inhibition of CCR4 has been shown to be effective in treating other inflammatory diseases, it is possible that using monoclonal antibodies to bind to CCR4, preventing CCL22 from binding, may prove to be another effective treatment for inflammation and lesional skin in patients with atopic dermatitis.

## **Introduction**

Atopic dermatitis, or AD, is a chronic, irritating skin disease that can affect anyone of any age (Sroka-Tomaszewska and Trzeciak, 2021). In the United States alone, 7.3% of adults, 15% of teens/tweens, and 24% of children ages 0-5 years have been diagnosed with atopic dermatitis (Hadi et al., 2021). The disease can cause symptoms including itching, lesional skin, inflammation, and being more prone to skin infections (Hadi et al., 2021). Lesional skin in atopic dermatitis can present as rough, scaly skin. The symptoms of atopic dermatitis are caused by the activation of certain Th2 cells, which then activate cytokines, triggering inflammation (Villani et al., 2021). Chemokines are small proteins known for initiating the migration of other cells (Stone et al., 2017). Specific chemokines such as CCL22 and CCL17 are involved in further stimulating inflammation since they attract immune cells to existing sites of inflammation, subsequently inducing inflammation (Carola et al., 2021). CCL22 and CCL17 initiate their inflammatory action once they bind to CCR4, their only receptor. The pathway for lesional skin development in atopic dermatitis, overall, involves Th2 cells releasing various inflammatory cytokines which

are then directed to and accumulate at sites of lesional skin by CCR4-bound chemokines, CCL22 and CCL17 (Scheu et al., 2017).

Common treatments for atopic dermatitis include emollients, soap-free cleansers, and corticosteroids. These topical treatments are the primary and more cost-effective treatments for inflammation and lesional skin in patients with atopic dermatitis. Novel medications such as crisaborole and dupilumab have also proved helpful but tend to be expensive (Frazier and Bhardwaj, 2020). Dupilumab, in particular, is a monoclonal antibody, a personalized therapeutic agent that mimics the immune system to target specific antigens (Malik and Ghatol, 2023). Another monoclonal antibody treatment for atopic dermatitis is tralokinumab. Dupilumab and tralokinumab target similar cytokines; dupilumab targets interleukin-13 (IL-13) and interleukin-4 (IL-4) while tralokinumab targets only IL-4. Dupilumab acts by binding to the receptors of IL-13 and IL-4 (D'Ippolito and Pissano, 2018). Tralokinumab binds directly to IL-13 to inhibit its function (Wollenberg et al., 2021).

These monoclonal antibody treatments, however, have proven to fall short in a few areas. Dupilumab, although effective on its own, has shown to work exceedingly well only when paired with topical corticosteroids (Bruin-Weller 2021). Dupilumab has also shown to lack efficacy in the head and neck areas (Vittrup et al., 2023). These areas where current treatments lack may provide room for new, more effective treatments to be researched and developed.

### **Inflammation Pathway of Atopic Dermatitis**

Inflammation in patients with atopic dermatitis begins with T-cells (Dong, 2021). T-cells, also known as T lymphocytes, are a type of white blood cell that produce cytokines in immune responses (Sauls et al., 2023). Th2 cells, a type of T-cell, produce cytokines such as IL-4 or IL-13; cytokines are small proteins that regulate inflammation. However, in lesional skin in those with atopic dermatitis, cytokines such as IL-13 and IL-4 become overexpressed and play a multifaceted role in promoting inflammation (Napolitano et al., 2023). CCR4 is a chemokine receptor expressed on Th2 cells (Yoshie, 2021). The binding of chemokine CCL22 to CCR4 plays a crucial role in recruiting the CCR4-expressing T-cells to sites of inflammation. Binding of CCL22 to CCR4 results in numerous T-cells accumulating in one area, further promoting inflammation in those with atopic dermatitis. This occurs due to CCL22 directing and signaling interleukins to the sites of inflammation. Increased levels of CCL22 have correlated with more intense inflammation (Seo et al., 2015). The relationship between CCR4 and CCL17, another chemokine, is similar to that of CCR4 and CCL22. However, CCL22 has been shown to more rapidly bind to CCR4 and to contribute more significantly to CCR4 internalization, a process that regulates the behavior of T-cells (Mariani et al., 2004).

### **Current Monoclonal Antibody Treatments**

Monoclonal antibodies have been used to successfully treat autoimmune diseases and allergic reactions such as psoriasis, rheumatoid arthritis, and others (Puthenpurail et al., 2021).

However, only a few successful monoclonal antibody treatments are currently used to treat atopic dermatitis.

Dupilumab and tralokinumab are two of the more current and commonly used monoclonal antibody treatments for atopic dermatitis. Dupilumab is designed to inhibit IL-4 and IL-13 by inhibiting their receptors, the type I and type II receptors for IL-4, and type II receptor for IL-13 (Iwaszko 2021). By doing this, dupilumab prevents IL-4 and IL-13 from downstream signaling and promoting inflammation (D'Ippolito and Pissano, 2018). Similarly, tralokinumab is a monoclonal antibody that inhibits IL-13 by binding to IL-13 itself, preventing IL-13 from interacting with receptors on its target cells (Wollenberg et al., 2021). However, both of these treatments are not perfect, and despite their efficacy, they still fall short in a few areas. Dupilumab has been shown to improve most skin lesions for short-term and long-term use. Maximal patient response was observed when dupilumab was paired with corticosteroids (Bruin-Weller 2021). However, dupilumab has shown little efficacy in the head and neck areas (Vittrup et al., 2023). Clinical response to tralokinumab, in a real-world setting, has shown sometimes to be progressive and may need co-treatment with other medications (De Greef et al., 2023).

Mogamulizumab is another monoclonal antibody that targets and binds to CCR4 and is primarily used to treat cutaneous T-cell lymphoma. Since CCR4 is expressed on the surface of malignant T-cells, once mogamulizumab binds to CCR4, it can release a response to eliminate these T-cells. With the depletion of these cells, inflammation for cutaneous T-cell lymphoma is also reduced (Watson and Marx, 2021). Since the inflammation pathway in cutaneous T-cell lymphoma is similar to that of atopic dermatitis, it is possible that the same route of monoclonal antibody targeting could relieve inflammation in those with atopic dermatitis. By applying this same mechanism to the inhibition of CCL22 binding to CCR4, it is possible that lesional skin in those with atopic dermatitis could potentially improve.

### **Theorizing How Monoclonal Antibodies Designed to Prevent CCL22 from Binding to CCR4 Could Be an Additional Approach to Preventing Lesional Skin**

To test whether or not monoclonal antibodies designed to target CCR4 alleviates inflammation and lesional skin, the following experiment is proposed. Test subjects would consist of a group of 90 BALB/c mice of ages 6-8 weeks who have chemically induced lesional skin using hydrogel patches containing ovalbumin (OVA) and  $\delta$ -toxin. In previous studies, BALB-c mice, similarly to patients with AD, have proven to have CCL17 and CCL22 levels that correlate with the intensity of skin lesions. Here, higher levels of CCL22 and CCL17 correlated with more intense and severe skin lesions. These skin lesions were induced most efficiently with hydrogel patches containing OVA and  $\delta$ -toxin (Matsuo et al., 2018).

Thirty of these mice would then receive an intravenous injection of monoclonal antibodies, another thirty would receive an intravenous injection of sterile saltwater as a positive control group, and a third group of thirty mice would not receive any injection, remaining as the negative control group. The two groups of mice that would receive injections would be injected

biweekly—once on the first day of the experiment and once again two weeks after the start of the experiment, the half-way point of the experiment.

Over 4 weeks, there would be three variables that would be regularly examined. First, whether or not CCL22 is bound to CCR4 would be determined using Co-immunoprecipitation (Co-IP). Co-immunoprecipitation is a technique that allows for protein complexes to be isolated and observed separately from a solution (Iqbal et al., 2018). Then, using ELISA, levels of IL-4 and IL-13 would be recorded weekly to observe changes in their concentration; these concentrations are hypothesized to decrease over time (Alhajj et al., 2023). Lastly, the amount of lesional skin would be measured twice a week using digital image analysis. The image analysis could measure the specific amount of lesional skin on the mice through frequently taken photos of the mice. An ANOVA test would then be used to compare the progress and difference in lesional skin amounts between the mice that received monoclonal antibodies and the control groups.

## **Conclusion**

Inflammation in atopic dermatitis is stimulated by the production and activation of Th2 cells and specific inflammatory cytokines such as IL-13 or IL-4. When CCL22 and CCL17 bind to their receptor, CCR4, inflammatory cytokines are brought to and cluster up at sites of inflammation, furthering the development of that inflammation. As a result of this, higher levels of CCL22 are correlated with the intensity of inflammation in those with atopic dermatitis.

Although there are existing treatments for lesional skin in atopic dermatitis, using specifically designed monoclonal antibodies that target and bind to CCR4 may prove more effective. By preventing CCL22 from binding to CCR4, the subsequent Th2 cell activation could be prevented, further preventing the release of interleukins. This may significantly reduce inflammation and lesional skin created by the release of interleukins such as IL-4 or IL-13. Since this method targets the cause of lesional skin at the source, a monoclonal antibody therapy targeting CCL22 binding to CCR4 may effectively reduce skin lesioning and inflammation .

## Works Cited

- Alhaji, M., Zubair, M., & Farhana, A. (2023). Enzyme Linked Immunosorbent Assay. In StatPearls. StatPearls Publishing.
- Carola, C., Salazar, A., Rakers, C., Himbert, F., Do, Q. T., Bernard, P., & von Hagen, J. (2021). A Cornflower Extract Containing N-Feruloylserotonin Reduces Inflammation in Human Skin by Neutralizing CCL17 and CCL22 and Inhibiting COX-2 and 5-LOX. *Mediators of inflammation*, 2021, 6652791. <https://doi.org/10.1155/2021/6652791>
- D'Ippolito, D., & Pisano, M. (2018). Dupilumab (Dupixent): An Interleukin-4 Receptor Antagonist for Atopic Dermatitis. *P & T : a peer-reviewed journal for formulary management*, 43(9), 532–535.
- de Bruin-Weller, M., Merola, J. F., Hong, C. H., Baldrich, E. S., Ettler, K., Sierka, D., Delevry, D., Chen, Z., & Rossi, A. B. (2021). Efficacy of Dupilumab in Atopic Dermatitis: The Patient's Perspective. *Dermatology and therapy*, 11(6), 2123–2131 <https://doi.org/10.1007/s13555-021-00621-w>
- De Greef, A., Ghislain, P. D., Bulinckx, A., Coster, A., de Halleux, C., Damsin, T., Jacobs, M. C., Suys, E., Zoghaib, S., & Baeck, M. (2023). Real-Life Experience of Tralokinumab for the Treatment of Adult Patients with Severe Atopic Dermatitis: A Multicentric Prospective Study. *Clinical drug investigation*, 43(4), 299–306. <https://doi.org/10.1007/s40261-023-01258-7>
- Dong C. (2021). Cytokine Regulation and Function in T Cells. *Annual review of immunology*, 39, 51–76. <https://doi.org/10.1146/annurev-immunol-061020-053702>
- Frazier, W., & Bhardwaj, N. (2020). Atopic Dermatitis: Diagnosis and Treatment. *American family physician*, 101(10), 590–598.
- Hadi, H. A., Tarmizi, A. I., Khalid, K. A., Gajdacs, M., Aslam, A., & Jamshed, S. (2021). The Epidemiology and Global Burden of Atopic Dermatitis: A Narrative Review. *Life (Basel, Switzerland)*, 11(9), 936. <https://doi.org/10.3390/life11090936>
- Iqbal, H., Akins, D. R., & Kenedy, M. R. (2018). Co-immunoprecipitation for Identifying Protein-Protein Interactions in *Borrelia burgdorferi*. *Methods in molecular biology (Clifton, N.J.)*, 1690, 47–55. [https://doi.org/10.1007/978-1-4939-7383-5\\_4](https://doi.org/10.1007/978-1-4939-7383-5_4)
- Iwaszko, M., Biały, S., & Bogunia-Kubik, K. (2021). Significance of Interleukin (IL)-4 and IL-13 in Inflammatory Arthritis. *Cells*, 10(11), 3000. <https://doi.org/10.3390/cells10113000>
- Malik, B., & Ghatol, A. (2023). Understanding How Monoclonal Antibodies Work. In StatPearls. StatPearls Publishing.
- Mariani, M., Lang, R., Binda, E., Panina-Bordignon, P., & D'Ambrosio, D. (2004). Dominance of CCL22 over CCL17 in induction of chemokine receptor CCR4 desensitization and internalization on human Th2 cells. *European journal of immunology*, 34(1), 231–240. <https://doi.org/10.1002/eji.200324429>
- Matsuo, K., Nagakubo, D., Komori, Y., Fujisato, S., Takeda, N., Kitamatsu, M., Nishiwaki, K., Quan, Y. S., Kamiyama, F., Oiso, N., Kawada, A., Yoshie, O., & Nakayama, T. (2018).

- CCR4 Is Critically Involved in Skin Allergic Inflammation of BALB/c Mice. *The Journal of investigative dermatology*, 138(8), 1764–1773.  
<https://doi.org/10.1016/j.jid.2018.02.027>
- Napolitano, M., di Vico, F., Ruggiero, A., Fabbrocini, G., & Patrino, C. (2023). The hidden sentinel of the skin: An overview on the role of interleukin-13 in atopic dermatitis. *Frontiers in medicine*, 10, 1165098. <https://doi.org/10.3389/fmed.2023.1165098>
- Puthenpurail, A., Rathi, H., Nauli, S. M., & Ally, A. (2021). A BRIEF SYNOPSIS OF MONOCLONAL ANTIBODY FOR THE TREATMENT OF VARIOUS GROUPS OF DISEASES. *World journal of pharmacy and pharmaceutical sciences*, 10(11), 14–22.
- Sauls, R. S., McCausland, C., & Taylor, B. N. (2023). Histology, T-Cell Lymphocyte. In *StatPearls*. StatPearls Publishing.
- Scheu, S., Ali, S., Ruland, C., Arolt, V., & Alferink, J. (2017). The C-C Chemokines CCL17 and CCL22 and Their Receptor CCR4 in CNS Autoimmunity. *International journal of molecular sciences*, 18(11), 2306. <https://doi.org/10.3390/ijms18112306>
- Seo, S. C., Park, S. J., Park, C. W., Yoon, W. S., Choung, J. T., & Yoo, Y. (2015). Clinical and immunological effects of a forest trip in children with asthma and atopic dermatitis. *Iranian journal of allergy, asthma, and immunology*, 14(1), 28–36.
- Sroka-Tomaszewska, J., & Trzeciak, M. (2021). Molecular Mechanisms of Atopic Dermatitis Pathogenesis. *International journal of molecular sciences*, 22(8), 4130.  
<https://doi.org/10.3390/ijms22084130>
- Stone, M. J., Hayward, J. A., Huang, C., E Huma, Z., & Sanchez, J. (2017). Mechanisms of Regulation of the Chemokine-Receptor Network. *International journal of molecular sciences*, 18(2), 342. <https://doi.org/10.3390/ijms18020342>
- Villani, A. P., Pavel, A. B., Wu, J., Fernandes, M., Maari, C., Saint-Cyr Proulx, E., Jack, C., Glickman, J., Choi, S., He, H., Ungar, B., Estrada, Y., Kameyama, N., Zhang, N., Gonzales, J., Tardif, J. C., Krueger, J. G., Bissonnette, R., & Guttman-Yassky, E. (2021). Vascular inflammation in moderate-to-severe atopic dermatitis is associated with enhanced Th2 response. *Allergy*, 76(10), 3107–3121. <https://doi.org/10.1111/all.14859>
- Vittrup, I., Krogh, N., Larsen, H., Elberling, J., Skov, L., Ibler, K., Jemec, G., Mortz, C., Dalager, M., Egeberg, A., Agner, T., Deleuran, M., Vestergaard, C., Thyssen, J. (2023, January 6). A nationwide 104 weeks real-world study of ... - wiley online library. Wiley Online Library. <https://onlinelibrary.wiley.com/doi/10.1111/jdv.18849>
- Watson, S., & Marx, J. B. (2019). Mogamulizumab-kpkc: A Novel Therapy for the Treatment of Cutaneous T-Cell Lymphoma. *Journal of the advanced practitioner in oncology*, 10(8), 883–888. <https://doi.org/10.6004/jadpro.2019.10.8.10>
- Wollenberg, A., Blauvelt, A., Guttman-Yassky, E., Worm, M., Lynde, C., Lacour, J. P., Spelman, L., Katoh, N., Saeki, H., Poulin, Y., Lesiak, A., Kircik, L., Cho, S. H., Herranz, P., Cork, M. J., Peris, K., Steffensen, L. A., Bang, B., Kuznetsova, A., Jensen, T. N., ... ECZTRA 1 and ECZTRA 2 study investigators (2021). Tralokinumab for moderate-to-severe atopic dermatitis: results from two 52-week, randomized, double-blind, multicentre,

placebo-controlled phase III trials (ECZTRA 1 and ECZTRA 2). *The British journal of dermatology*, 184(3), 437–449. <https://doi.org/10.1111/bjd.19574>

Yoshie O. (2021). CCR4 as a Therapeutic Target for Cancer Immunotherapy. *Cancers*, 13(21), 5542. <https://doi.org/10.3390/cancers13215542>



## **The Role of Women in STEM in WWII by Catherine Zeng**

In the United States, women have long been marginalized in the public sphere. Even when they contributed to historical events, such as the American Civil War, or World War I, their involvements were regarded as restrained in the homefront or private sphere. However, during World War II, women in the United States played far more significant and visible roles. This paper takes a particular look at their contributions to unprecedented scientific breakthroughs, which derived from the political atmosphere in the 1920s and led to an increase in women's participation in STEM-related employment opportunities afterward.

Throughout history, women have always been portrayed as the emotional support for men. This became a social standard that was abnormal to break. The transition into the twentieth century was no different. It brought many pre-existing gender norms that had been normalized for millennia into the next century. Prevailing social policies for women in the early twentieth century included the idea that women should only have jobs undesired by men or none at all. It was a standard theory that women from the middle or upper class should not work as it symbolized being from "low social status." Women from wealthier socioeconomic classes believed that they were simply "above" working. However, for those who did have jobs during the 1930s, many policies barred married women from the workforce and fired newly married women to enforce these gender norms. Likewise, another custom that rose to popularity during the Great Depression was the idea that women should give up their jobs to unemployed men. This contributed to modern ideals concerning fragile masculinity, as it would be "unmanly" for a man to lose his job to a woman. With such historical contexts, women in the nineteenth century experienced another surge of ideologies that emerged from the 1770s, such as the Cult of Domesticity and Republican Motherhood, which revolved around the importance of women staying in the private sphere to educate their children on Republican ideals. These doctrines also enforced the idea that women should only be educated enough to pass on Republican ideals and for this purpose only. Up until the 1940s, these principles dominated the public sphere. WWII eroded values that constrained the employment of married women, abolishing most of the previously mentioned policies. This was largely due to the large-scale demand for homefront mobilization during the war, which stunted a gradual trajectory of increased rates of women's employment. Not only did the war prove that women were capable of performing well in jobs outside the "pink collar" workforce (industries considered to be "women's work"), but it also gave them the opportunity to succeed in these positions and change the perceptions of many.

The women's suffrage movement of the 1920s paved the way for women to receive higher education and work in public service. The ratification of the Nineteenth Amendment in 1920 which granted women the right to vote also symbolized the success of the women's suffrage movement. This accomplishment sparked nationwide political reform and social change, especially in education and employment opportunities. The suffragist movement laid the groundwork for women hoping to achieve an education in science, technology, engineering, or mathematics (STEM) through the establishment of more schools and higher monetary allotments

for public education, furthering the literacy of the upcoming generation that would heavily impact WWII. By educationally preparing them for potential discoveries and new advancements, this generation of women would directly develop our nation's technology.

The scale and mobilization efforts of WWII were unparalleled by previous wars as it is generally regarded as the first modern war due to its wide usage of mechanical weapons and airpower. WWII gave rise to the increase in women's employment during and following the war as the extreme demands of WWII caused women to fill many roles that were previously considered "jobs for men." Women's achievements during WWII demolished the myth that women were not as rational or intelligent as men, instead, it proved that they were just as capable when given the chance. While most women took up jobs on the "home front", such as the manufacturing industry, many female intellectuals also played parts in technological and military aspects of the war. The increased involvement of women in the labor force during WWII made their accomplishments more unique which diversified their job opportunities after the war. While women's participation in WWII was revolutionary, it did not have an immediate impact on women's employment, instead, the impact was more prominent long term. WWII did not completely change the standard for gender stereotypes and most returned to their familiarized outlooks after the war, forcing some women out of the job industry to create room for returning veterans. Despite this temporary deviation, women's employment rates continued to grow in the decades after WWII, showing the gradual legacy of the war mobilization. With new social perceptions of women's capability, the women's rights movement in the 1960s became increasingly proactive, calling for equal employment opportunity and equal pay.

An increase in women's education after the women's suffrage movement allowed more women to receive an education in science and engineering, thus qualifying them for more advanced positions, especially in STEM fields. Specifically, the women's suffrage movement of the 1920s profoundly impacted the education of the younger generation: more children stayed in school. According to a curated article by Giving Compass, a study made by Na'ama Shenhav, Esra Kose, and Elira Kuka digitized local school enrollment and school-spending figures from the early twentieth century for more than five hundred U.S. cities with populations of at least 10,000. Through this study, they discovered that on average, suffrage increased spending on local education by 9% and was correlated with a rise in school enrollment (Wong, par. 4). As expenditures and the number of students pursuing and staying in higher learning increased, the population as a whole experienced higher rates of literacy and was more well-educated. Likewise, as priorities and monetary funds shifted towards educating younger generations, this naturally set students up for brighter futures that allowed them to qualify for and, as a result, receive more job opportunities for advanced positions. This was a first step in the right direction towards more careers in STEM, which was further promoted by Ana Roqué de Duprey's work in Puerto Rico. In the early twentieth century, Duprey, an educator and women's suffragist, founded many girls-only schools and the College of Mayagüez, which later became the University of Puerto Rico campus. The foundation of schools for women enabled more women to receive degrees in STEM fields. This naturally led to both social and economic development as women

could qualify for better job opportunities to contribute to the household income and step out of the private sphere. It also exemplifies women's competence because they proved that they could become successful whilst studying these advanced topics previously thought of as “only for men.” By setting up girls-only schools, Duprey’s dedication to public education has allowed aspiring female scholars to pursue higher education in a space where any possible prejudices and competition against male students for resources were eliminated. Duprey’s legacy was effective in closing the social gap that was widely perceived as educational differences between the two genders. Likewise, Katherine Johnson, one of the most notable women in STEM, was an African-American space scientist and mathematician who furthered and modeled educational values supporting women in scientific fields. Her invaluable contribution to NASA during her 33-year career included major advancements for the United States during the Space Race against Russia in the 1960s and 70s. Johnson was responsible for calculating trajectories for Alan Shepard and the Apollo 11 flight, paving the way for him as the first American in space. Moreover, the recent production of the movie *Hidden Figures* portrays the work experiences of Katherine Johnson, Dorothy Vaughan, and Mary Jackson, three African American women who worked at NASA during a period of prevailing racial and gender discrimination. This movie in particular highlights the progression of the three women’s positions in the workplace over time as officials at their NASA headquarters started to overlook social conformities because of their diligent job performances and tenacity. As they climbed work titles, these three women laid the groundwork so that future women, specifically women of color, could reach the pinnacle of professionalism in scientific industries without being hindered by any unjust prejudices.

While the increase in women’s access to STEM education prepared women in the 1940s to take on advanced jobs, the scale of WWII, being the first modern warfare, gave women opportunities to contribute beyond the traditional homefront. Due to the breadth of WWII, the U.S. required mass participation in the war which effectively increased home front production efficiency. With a majority of working men leaving their jobs to join the armed forces, women were finally allowed and even encouraged to step up to fill these roles, as marked by the increase in propaganda promoting women to join the war effort. More specifically, a substantial number of women became factory workers to support the United States’ participation in WWII. This is exemplified through the work of the Calutron Girls, a group of recent high school graduates recruited by the Tennessee Eastman Company during wartime labor shortages to operate calutron spectrometers. These machines used electromagnetic separation to isolate uranium that was used to produce the first nuclear bombs during WWII. Notably, the enriched uranium produced by the Calutron Girls was used in ‘Little Boy’, the atomic bomb dropped on Hiroshima, Japan near the end of the war. The combined efforts of the Calutron Girls were critical to the industrialization of the United States during WWII, and their involvement represented just a fraction of all women who worked hazardous jobs to sustain America through the war. This disproved the common social perception of women only being able to work “pink-collar” because the Calutron Girls proved that women were capable of working jobs, even dangerous ones. Similarly, the Aluminum Company of America’s factory plant (ALCOA) in Knoxville, Tennessee produced

34% of the country's aluminum supply, a resource essential for the production of airplanes. While men still worked at this factory, women were the ones who made the plant as successful as it was. Despite the co-ed employment, the addition of women in the ALCOA factory contributed to the successful outcome of the plant, which accentuated the difference that women made in the workforce, boosting America's production power in the war. The ALCOA plant's success solidified the idea that women could perform their jobs as proficiently as men, helping lift some of the prevailing gender stereotypes of the time.

Women's scientific contribution to the U.S. extends beyond the manufacturing side. The legacy of Florence Rena Sabin furthered these feminist ideologies through her Sabin program, a series of new health laws made to create reform for Colorado's poor funding and lack of properly certified staff. Her advocacy worked to help Colorado recover from WWII and enable other aspiring female physicians. She was one of many firsts: the first woman accepted to Rockefeller Institute, the first female faculty member at Johns Hopkins University, and the first woman elected to the National Academy of Sciences membership. However, these accomplishments did not come without hardships--in this case, workplace misogyny. On multiple occasions, her less-experienced male coworkers were chosen for promotions over her, an unfortunately common circumstance that still happens in modern workplaces. Her grit and eventual success paved the path for future women seeking careers in the biomedical field and all STEM fields. Although a stepping stone in American history, her achievements were important milestones for women's history, expanding society's perceived capabilities of women in the workforce. These effects were echoed in the 1940s when the United States experienced the largest proportional increase in female employment across the century. Since the agricultural industry served as the backbone that sustained the U.S. through WWII, states with lower percentages of farmers had higher mobilization rates during the war, meaning that more men left work to serve. This opened doors for women to join or be part of the workforce, creating a demand for jobs that were emptied because of the war. As a result, women temporarily took the place of men in the workforce, and the war proved to employers that women could perform just as well when placed on equal pedestals.

While many believe that women's main contribution to the war was their mobilization of the homefront, this is an underestimation: women have also played decisive roles in the war itself. They were often the brains behind modern technologies that revolutionized the war. In particular, Leona Woods Marshall Libby worked as one of the main physicists on the Manhattan Project, a program created from 1942 to 1945 to develop the first nuclear weapons. Libby was the only female scientist on the team, and she is credited as the only woman who created the Chicago Pile, which served as the world's first nuclear reactor and the basis for the aforementioned first atomic bomb, 'Little Boy.' Her work on the Manhattan Project was a game-changer for the Allied Powers as the atomic bombs dropped on Hiroshima and Nagasaki played a determinant role in the Japanese surrender, officially concluding WWII. Libby's scientific discoveries functioned as a legacy for increasingly advanced technologies, but most

importantly, set a precedent for the inclusion of women in these momentous projects that directly shaped history.

Comparably, the Women's Army Corps started as an auxiliary for other U.S. armed forces during the war effort. Despite the majority of Congress objecting to the formation of a Women's Reserve, Marine Lieutenant General Holland M. Smith argued that women Marines should be stationed at Pearl Harbor to release men for overseas deployment. The two officers and Navy Secretary James V. Forrestal informed Congress that Hawaii needed 5,000 female naval soldiers. The demand for women's involvement in the war led to the sanction of a new legislation on September 27, 1944: Public Law 441, 78th Congress, which authorized the establishment of Women Accepted for Volunteer Emergency Service (WAVES) and the United States Coast Guard Women's Reserve (SPARS). The law also allowed members of the Women's Reserve to be assigned duty in areas of the continental United States. The passage of this law allowed for the distribution of 21 officers and 366 enlisted Women Reservists in Ewa, Hawaii, where the women's reserves ran a motor transport section that served almost 16,000 individuals each month. These women provided first-hand assistance to the U.S. Navy during WWII, working beyond the home front and directly in active military spaces. These efforts were effective in proving the need for women's involvement in the war and their subsequent success in stepping up for these roles. Moreover, the actions of the Women's Reserves sidestepped the conventional gender stereotypes that condemned women who served, increasing the diversity in war-related roles.

In particular, Admiral Grace Murray Hopper was one of the Naval Reserve Officers who benefited from the passage of Public Law 441. Although not on the front lines of the war, she worked on the Harvard Mark IV computer in 1944 under the guidance of Howard Aiken, becoming his most valued researcher on the programming team. The computer was completed in 1952 and was used significantly in the U.S. Air Force, a feat that supported the progression of America's aviation future. Before these accomplishments, women were used as computers to help develop bomb trajectory tables. However, Hopper aided in transforming the meaning of the term "computers" from standing for "mathematically adept women working in statistics and data" to physical machines that did the same work. Her efforts helped replace the tedious manual labor and social degradation that came with correlating women to these roles. Hopper's legacy also includes the Grace Hopper Celebration, a driving force behind today's Women In Technology movement and the largest gathering of female and non-binary identifying technologists. Its annual job fair, still relevant today, offers women more opportunities to be hired by STEM corporations, promoting gender equality in a predominantly male industry. Ultimately, these women refuted the previously existing stereotype that women only contributed through the home front and that women were limited in their support for the war effort. While this may have been true for other wars, WWII contrasted with those wars as it enabled women to play intellectual roles in the advancement of war mechanization and provide immediate assistance on the battlefield.

While it is evident that women's employment rates skyrocketed during WWII, the long-term effect was not as dramatic as many employers reinstated former values following the war. With the return of men who had come back from serving in the army, the job applicant pool was enlarged and employment prioritization and opportunities were relinquished back to men. Half of the women drawn into the workforce through WWII left in 1950 and female auxiliaries for the military were no longer needed after the war. The demobilization procedures that followed WWII called for mandatory resignation or discharge of all women's reserves, including officers and active members, by September 1, 1946. Commanding officers would release women from their stations and disband units with strengths below 100. However, resistance and reconsideration in the middle of the drive prompted decisions that invited 300 women and 12 officers to stay to form a new unit: Company E, 1st Headquarters Battalion, U.S. Marine Corps. The continuation of women in the armed forces demonstrated the overall growth of women's employment throughout the 1940s, signaling that there was still a substantial increase despite slowed progression. Furthermore, policies that had previously prohibited married women from working became outdated, and the proportion of women in the workforce grew significantly in the latter half of the twentieth century. Specifically, 18 million female workers took up approximately 30% of the entire workforce in 1950. In 2000, this number increased to 66 million female workers representing 47% of the workforce, a more leveled job distribution between the sexes. These statistics of working women reflected women's contribution to the flourishing of wealth in the 1950s as their saved wages helped cover down payments on houses and other installments towards household necessities. In the two decades after WWII, the U.S. economy experienced major developments including productivity increases, higher standards of living, and accelerated growth in college enrollments--a direct result of women joining the workforce. However, the impacts of women's employment extended even beyond the 1960s as economic growth stimulated higher demands for labor that occurred simultaneously with major social reforms like the civil rights movement, the equal opportunity and pay movement, and the women's rights movement. The effects of these reforms would be recycled back into women of the next generation as they created more hospitable conditions for women in the public sphere.

Overall, women's participation in WWII has constructed a sustainable string of beneficial outcomes for both the social and economic atmospheres of the United States. Throughout the war, women scientists, mechanics, and workers contributed to the American and Allied victory in unprecedented ways. Following the war, more employers were willing to hire women after seeing that their professionalism was at par with their male counterparts, a stimulus for the rise in women's employment in the 1950s. Despite a temporary call for women to return to the family in the late 1950s and 60s, women in the U.S. continued to showcase their strength and break glass ceilings at work. Without the efforts of pioneering women in the 1940s, women today may still be the underrepresented minority that they were a century before. Women's influences were revolutionary at the time, but are even more relevant in the long term.

## Works Cited

- Acemoglu, Daron. "Women and Post-WWII Wages." *NBER*,  
www.nber.org/digest/nov02/women-and-post-wwii-wages. Accessed 23 Apr. 2024.
- "Changing the Face of Medicine | Florence Rena Sabin." *U.S. National Library of Medicine*,  
National Institutes of Health, 14 Oct. 2003,  
cfmedicine.nlm.nih.gov/physicians/biography\_283.html. Accessed 23 Apr. 2024.
- Goldin, Claudia D. "The Role of World War II in the Rise of Women's Employment." *JSTOR*,  
1991,  
scholar.harvard.edu/files/goldin/files/the\_role\_of\_world\_war\_ii\_in\_the\_rise\_of\_womens  
\_employment.pdf. Accessed 24 Apr. 2024.
- Lerner, Louise. "The First Nuclear Reactor, Explained." *University of Chicago News*,  
news.uchicago.edu/explainer/first-nuclear-reactor-explained. Accessed 23 Apr. 2024.
- Mallory. "Admiral Grace Murray Hopper: When Women Were Computers: The National WWII  
Museum: New Orleans." *The National WWII Museum | New Orleans*, The National  
World War II Museum, 25 Mar. 2022,  
www.nationalww2museum.org/war/articles/grace-hopper-woman-computer. Accessed 23  
Apr. 2024.
- May, Elaine Tyler. "Women and Work." *PBS*,  
www.pbs.org/wgbh/americanexperience/features/tupperware-may/. Accessed Apr. 2024.
- Stremlow, Mary V. "Free a Marine to Fight: Women Marines in World War II." *Marines.Mil*,  
www.marines.mil/Portals/1/Publications/Free a Marine to Fight Women Marines in  
World War II PCN 19000312900\_2.pdf. Accessed 24 Apr. 2024.
- The Atlantic. "How Women's Suffrage Improved Education." *Giving Compass*, 26 May 2020,  
givingcompass.org/article/how-womens-suffrage-improved-education-for-a-whole-gener  
ation-of-children. Accessed 23 Apr. 2024.
- "The Untold History of Women in Science and Technology." *National Archives and Records  
Administration*, obamawhitehouse.archives.gov/women-in-stem. Accessed 23 Apr. 2024.
- Toossi, Mitra. *A Century of Change: The U.S. Labor Force, 1950–2050*, Bureau of Labor  
Statistics, May 2002, www.bls.gov/opub/mlr/2002/05/art2full.pdf. Accessed Apr. 2024.
- Walker, Joel. "Women in the Work Force during World War II." *National Archives and Records  
Administration*,  
www.archives.gov/education/lessons/wwii-women.html#:~:text=After%20the%20war%2  
C%20most%20women,workforce%20became%20a%20common%20sight. Accessed 23  
Apr. 2024.

# **The Influence of User-Generated Content on Brand Perception in Social Media Shopping - Cross-Cultural Analysis by Gretel Garcia**

## **Abstract**

Recognizing how user-generated content (UGC) affects customer behavior is essential for companies looking to improve their marketing approaches. By comprehending the impact of user-generated content (UGC) on brand perception and purchase decisions, businesses can tailor their methods to engagement and content to better connect with their target audience. This research examines the traits of influencers—such as their ethnic backgrounds—that help to mold the perceptions of consumers and the identity of brands. In general, the objective is to produce insightful information about how influencers affect online shopping in diverse cultural contexts. Businesses can create more impactful and culturally sensitive marketing strategies that improve client engagement and loyalty by examining these factors.

## **1 Introduction**

This research explores how consumer views of brands are shaped by user-generated content (UGC) when purchasing products on social media. It investigates how different types of UGC, including reviews, testimonials, and user-generated visual content, affect consumers' perceptions of brands, especially in light of their varied cultural origins. The goal of the study is to use cross-cultural analysis to find patterns and insights about how UGC influences brand perception in various cultural contexts. These findings will have important ramifications for brands that want to use UGC to their advantage in global social media marketing campaigns.

Understanding how user generated content influences consumer behavior is crucial for businesses looking to optimize their marketing strategies. The importance of this lies in understanding how different cultural contexts impact the effectiveness of user-generated content in shaping brand perceptions. This insight can help brands tailor their social media strategies to diverse audiences, ensuring that UGC resonates appropriately across various cultural segments, ultimately enhancing brand engagement and loyalty both globally and locally. Analyzing cross-cultural responses to UGC helps brands identify what works best in different regions. This can lead to more positive brand perceptions as companies align their content with the cultural expectations and preferences of their audience, reducing the risk of cultural insensitivity or miscommunication.

In this paper, we will define and describe key concepts such as social media, influencers, user-generated content, and influencer marketing. These concepts encompass subcategories, including influencer categories based on the number of followers, type of content, and industry niche. We address several critical questions related to influencer marketing, including the circumstances under which brands need to consider the cultural background of an influencer and how this background contributes to the success of an influencer campaign.

Additionally, we will explore what cultural background encompasses, such as ethnicity, experiences, socio-economic background, gender, and traditions. Furthermore, we will examine the types of influencer characteristics that are crucial for building brand identity, how influencers



can help shape a brand's image, and the importance of brand identity itself. We will also discuss strategies brands can use to positively influence consumer perceptions, the different types of consumer perceptions and behaviors, and why these perceptions are vital in influencer marketing. Through this exploration, we aim to provide a comprehensive understanding of the interplay between influencers, brand identity, and consumer perception.

### **Research Question**

In what ways do influencers shape consumer perceptions and how does their cultural background play a role in building brand identity?

## **2 Descriptions and definitions of main concepts - Background**

Social media has grown exponentially over the past two decades, revolutionizing how people communicate, share information, and interact online. This growth has been fueled by widespread internet use, smartphone adoption, and the rapidly growing advances in technology. Social networking has transcended national borders by connecting users from every corner of the globe (Beaulac). Platforms such as Instagram, Facebook, Twitter, Snapchat have billions of active users, making them powerful tools for communication and information distribution on a global scale. Social media has shifted traditional marketing strategies by offering brands direct access to its audiences and consumers (Chacko).

UGC refers to any form of content, such as text, images, videos or reviews that are created and shared by users in online platforms, rather than by the platform or the brand itself (dos Santos). Individuals, customers, or fans who voluntarily submit content based on their experiences, viewpoints, or interests are the source of UGC, which is frequently regarded as more authentic and trustworthy than branded content produced by businesses. Positive UGC can enhance brand reputation and credibility, attracting new customers and fostering loyalty among existing ones (Mailchimp).

Social media influencers are individuals who have established credibility and expertise in a particular subject area. They consistently share content related to their expertise across various social media platforms, attracting sizable and dedicated followings of interested and engaged individuals (Geyser). An influencer possesses the capability to affect purchasing decisions of others through their authority, expertise, and position with their audience. Influencers share their personal experiences, opinions on products, services, and brands which resonate with their followers. Consumers engage with their content through likes, comments, shares, and other interactions. These influencers can be categorized as opinion leaders (i.e., people that can change consumer perceptions) that communicate through a sizable number of followers (Geyser).

Influencer marketing is an approach through which social media users collaborate with brands to promote the brands' products or services (McKinsey). In 2023, the influencer marketing economy was valued at \$21.1 billion (McKinsey). Influencers can be compensated through various forms. For example, an influencer who promotes a product or service receives a set amount per post, which refers to a brand exchange. Another way influencers earn revenue is

by receiving payments whenever a consumer clicks on a specific link or utilizes a promotional code. Companies' interest in influencers has increased because it works for them effectively. A McKinsey 2014 survey indicated that influencers impact consumer purchasing decisions. More recently, “in 2022, an analysis of more than 2,000 influencer marketing posts found that the strategy does yield a positive ROI for brands.” (McKinsey). Return on investment (ROI) is used to compare the effectiveness of several distinct investments or assess how profitable or efficient an investment is (Fernando). The primary distinguishing factor of influencer marketing is its ROI when compared to other digital marketing strategies. Influencer marketing boasts an ROI that is 11 times higher than alternative digital media approaches (WebFX).

## **2.1 Influencer Categories**

Influencers can be categorized based on their number of followers, types of content, and specific niche. Within these classifications, there are subcategories. For instance, when categorizing influencers based on their number of followers, they are typically grouped into four categories: Mega-influencers, Macro-influencers, Micro-influencers, and Nano-influencers (Geysler). Macro influencers are typically more useful for businesses embracing influencer marketing due to the fact that they are more accessible for brands while being more cost effective compared to Mega-influencers. When analyzing how influencers are arranged by their types of content they fall in one or more of these groups: bloggers, youtubers, podcasters, and social posts only. Bloggers tend to have a genuine and active relationship with their followers. This is why brands value social media influencers for their ability to shape trends and motivate their followers to purchase products they endorse (Geysler).

### **2.1.1 Number of followers**

When analyzing the number of followers, influencers typically fall into four distinct categories. High-profile influencers, often termed mega-influencers, are often celebrities and boast extensive bases of followers. With a broad and diverse reach spanning international audiences, these influencers swiftly amplify product awareness. Consequently, brands gravitate towards them, despite encountering hurdles in securing brand deals due to their high demand and the substantial fees they command for sponsored posts, vlogs, or videos (Alzakhrafi). Mega-influencers may have an impressive following, and studies show that as their number of followers rises, so does engagement. More precisely, the engagement rate for Instagram influencers with more than 10 million followers is 1.6 percent (Sanders).

Following mega-influencers, the next tier often comprises macro-influencers, which typically rise to fame due to their expertise and credibility within a specific industry and have around 200,000 to 500,000 followers (Alzakhrafi). They establish authentic connections with their audience, fostering genuine engagement. These influencers are often sought after by brands with substantial marketing budgets, recognizing the potential for impactful collaborations.

After macro-influencers, the next tier typically includes micro-influencers, who typically have between 10,000 and 100,000 followers. Despite possessing a significant following, they remain genuine with their audience, earning a reputation for competence and credibility

(Alzakhravi). Because of their coveted status, companies looking for the best return on investment choose them because they can reach a sizable audience at a relatively cheaper cost than other influencers. Concentrating on micro influencers proves advantageous for companies operating on smaller budgets. By engaging with multiple micro influencers instead of a single macro influencer, businesses can achieve comparable audience reach while optimizing their spending on advertisements (Indeed). Although the content produced by micro influencers frequently has a more genuine feel to it than postings from macro or mega influencers, it frequently lacks the polished appearance. Depending on the distinctive business goals of the brand, this authenticity component may have a major effect on how well its influencer marketing campaigns work (Sanders).

Finally, Nano-influencers generally have between 1,000 and 10,000 followers. With a particular emphasis on specialized fields, they are exceptional at building incredibly strong bonds with their audience. Their followers engage with them authentically because they trust their knowledge, thereby engendering efficacy in influencer marketing strategies (Beichert et al.). For small to medium-sized enterprises, this type of influencer offers a great chance as a more affordable option than those with larger fan bases. Furthermore, nano-influencers may sometimes work together for free, realizing that both parties stand to gain from growing their following and helping companies improve their online visibility (Alzakhravi).

### **2.1.2 Type of content**

Influencers frequently show preferences regarding different campaign types and content formats; some are more inclined to create a wide variety of content, while others specialize in specific ones. Because of the tiered structure of this diversity, influencers can align with companies in a variety of ways. These could include sponsored posts, in which influencers openly promote products on social media sites like X (Twitter), Instagram, and YouTube, as well as reviews or recommendations, in which they provide their followers frank feedback (Puylaert). Influencers can also produce tutorials or how-to guides that show off how to use products, participate in product unpacking videos to express their first thoughts, or work together on giveaways and contests to increase interaction.

Product promotion might take the form of special discounts, shout-outs, and guest posts on blogs, vlogs, or podcasts to improve brand relatability. Influencers can communicate directly with audiences through “Ask Me Anything” (AMA) or Q&A sessions, while account takeovers give influencers temporary authority over a brand's social media accounts in order to create content. In the final category, brand ambassadors promote entire companies and goods, frequently through product placements or sponsored content. To achieve campaign goals, companies have a variety of payment structures, including as retainers, monthly payments, and one-time costs (Puylaert).

### **2.1.3. Niche and industry**

Influencers span various industries and niches, including food, health and wellness, fashion, lifestyle, memes and pop culture, travel, family, gaming, animals, and beauty. Influencers in various fields are experts at developing material specific to their niche markets (Puylaert ; Worb). Food influencers showcase their meals and dining experiences while sharing recipes, cooking advice, and culinary experiences. Influencers in the health and wellness arena provide knowledge on subjects including diet, exercise, mental health, and general wellbeing with the goal of enlightening and motivating their audience. Fashion influencers provide product suggestions and outfit ideas while showing the latest trends in apparel, accessories, and style. Lifestyle influencers emphasize relatability and authenticity by documenting everyday activities such as travel, hobbies, and personal interests (Santora). Influencers that cover pop culture and memes produce fun material that revolves around celebrities, TV series, movies, and memes. Influencers in travel encourage individuals to explore the world by sharing their experiences, recommendations, and travel advice. Family influencers give advice and personal experiences to their audience while emphasizing discussion of parenting, family relations, and related subjects. Influencers in the gaming industry that focus on video games include those that stream, review, and talk about the culture surrounding gaming (Santora). Animal influencers focus on pets and other animals, and they share details of their daily life to build rapport with their audience (Girlboss). Lastly, beauty influencers produce content about skincare, makeup, and beauty goods and provide reviews, videos, and advice on how to improve beauty regimens.

### **3. How should brands choose influencers?**

Businesses should follow a systematic approach involving five key steps when selecting influencers (Wiley). Firstly, they should establish campaign goals and requirements to provide a clear direction. Then, they should compile a list of influencers whose content and audience demographics align with these objectives. Next, they should assess the engagement rates of these influencers to ensure effective audience interaction. Subsequently, they should verify that the selected influencers are relevant to their brand's offerings and target market (YEC). Finally, they should prioritize influencers who not only share the brand's values but also exhibit authenticity in their content, fostering genuine connections with their audience (Jovicic). While following this five-step process, brands need to consider two key factors when determining ideal influencers: reach and niche (YEC). Reach provides information about total audience size and engagement levels by including both direct followers and indirect interaction through social media's exploration and discovery aspects. On the other hand, niche marketing focuses on reaching influencers in certain fields of expertise (YEC).

Businesses seeking to partner with influencers can streamline the process of identifying an influencer. For example, utilizing branded hashtags can aid in locating creators already engaging with the brand or its products (Jovicic). Furthermore, exploring industry-relevant hashtags provides a channel to discover influencers actively discussing topics pertinent to the business's niche (YEC). Thirdly, conducting Google searches allows for the identification of influencers with a notable online presence beyond social media platforms. Additionally,

monitoring brand mentions across various social media channels can unveil potential influencers already discussing the brand (Jovicic). Employing keyword research facilitates the discovery of influencers creating content aligned with the business's niche. Lastly, following bloggers, podcasters, and other creators across different content platforms enables businesses to identify individuals whose values and audience align with their own (Jovicic).

For businesses to effectively choose the right influencers, they must have a clear understanding of their desired objectives. These objectives could include increasing brand awareness, creating engaging content, driving sales or app downloads, or expanding their newsletter subscribers or social media followers (Author G). Companies consider multiple criteria when selecting influencers (YEC). It's crucial for businesses to collaborate with influencers who are a good fit for their brand, envisioning them effectively promoting the company's goods and services to their audience (Jovicic). An influencer aligned with a brand will likely have an audience interested in purchasing the company's products. Additionally, brands seek influencers whose values resonate with their own, fostering an authentic connection between the influencer and the brand. Moreover, brands prioritize influencers who consistently produce high-quality content, as this UGC reflects the brand's image. Influencers with a consistent posting frequency often boast a loyal audience (Author G). Lastly, brands prefer influencers who are reliable communicators, as efficient communication ensures timely collaboration completion. In the next subsections, we discuss consumer perception, building brand identity, and influencer cultural background in greater detail.

### **3.1) Consumer Perception**

In influencer marketing, consumer perception is crucial, especially when it comes to the compatibility between influencers and companies (Ramya). When influencers genuinely share a brand's values and successfully market its goods or services, customers are more likely to see the partnership favorably. Their perception of the influencer as a reliable source promoting goods they sincerely believe in builds brand confidence. In addition, customers find authentic and captivating high-quality material produced by influencers (Choudhary). Their favorable opinion of the brand not only influences their purchases but also increases their brand loyalty. On the other hand, poor client perception might result from inconsistent messages, low-quality content, or misalignment between influencers and companies (Lampou). This can erode consumer trust and possibly discourage purchase intent. Consequently, companies need to pay close attention to customer perception when selecting influencers and crafting collaboration strategies to ensure a favorable reception among their target audience.

There are five distinct types of consumer perceptions: brand perception and exclusivity, preference for superior quality ("The Best"), individual cognitive patterns, personal attributes, and social influences (Maryville University). Brands frequently incorporate symbolic connotations in customer behavior that extend beyond their practical features. Some brands are regarded as status symbols that represent exclusivity, luxury, or social standing (Sambuno). Customers' choices and willingness to pay more for goods linked to prominent brands may be

influenced by this notion (Cortes). In addition to their intrinsic quality, consumers might seek out these brands because of the exclusivity and social cachet they have within their social circles (Maryville University). Some items have evolved into globally recognized symbols of success. These status markers silently but powerfully signify wealth, influence, and prestige both domestically and internationally (Sambuno).

Customers frequently assess brands according to whether they are thought to be better overall, in terms of quality, innovation, or value (Kirsch). Customers' preferences and purchase decisions are influenced by their perception of a brand, since they tend to choose companies they perceive to provide the finest goods or services available (EastHall Design). A number of factors, such as prior encounters, advertising campaigns, and word-of-mouth referrals, can affect this perception (Garvit). Brands that are able to effectively project an image of superiority and excellence frequently see increases in consumer satisfaction and loyalty.

Personal experiences and cognitive processes have major influences on how consumers behave (Maryville University). These thought processes include how people perceive data, form opinions, and come to decisions (Blue Monarch). Customers may choose differently depending on their situation due to a variety of preferences, prejudices, and mental shortcuts (Rose). In order to effectively personalize their messaging and services to resonate with their target audience, marketers must have a thorough understanding of these thought patterns.

Numerous personal factors, including gender, age, annual income, net worth, and cultural background, may have an additional impact on consumer behavior (Bhasin). The interests, inclinations, and buying patterns of consumers can be influenced by these variables (Management Study Guide). Generational cohorts, for instance, could have particular brand or product preferences, and cultural differences might affect how consumers perceive consumption (IMARC Services Private Limited). To create tactics that appeal to their target audiences, marketers need to consider these individual qualities.

Lastly, social influences have an immense effect on how consumers behave and make decisions. Social standards, peer groups, familial dynamics, and cultural trends are only a few examples of the many influences that fall under the broad category of social variables (Maryville University). Peer pressures may cause consumers to modify their tastes and habits in an effort to fit in or stand out from the others in their social circles (Niosi). Furthermore, social networks and interpersonal connections have the power to significantly influence the attitudes, preferences, and purchase decisions of consumers (Dahl). It is imperative for marketers to comprehend these social dynamics in order to formulate tactics that efficiently utilize social influence.

Brands can effectively shape consumer perceptions by implementing four strategies: highlighting the value proposition, building brand trust and credibility, leveraging emotional connection, and using specific pricing strategies (Weatherwax). Emphasizing value propositions includes effectively meeting customer needs and outlining their product's distinct advantages of features, which can positively influence consumer attitudes. Putting an emphasis on meeting needs and going above and beyond builds loyalty and trust, particularly in a time when value is valued above all else (Tlapek).

Furthermore, brands can establish credibility and trust by keeping their word about product features and marketing. In order to further favorably shape customer opinions, brands can also collaborate with influencers or industry experts to benefit from their credibility and build brand reputation (Weatherwax). When leveraging emotional connection, brands can develop a stronger emotional connection with their audience by narrating captivating brand stories that arouse favorable feelings in them (RebeccaLee). Creating a feeling of community also improves brand loyalty and fortifies emotional bonds, making a lasting effect on customers. Finally, brands should focus on implementing strategies for pricing (My Digital CMO). For example, putting value-based pricing into practice and modifying prices in response to demand are crucial strategies for improving customer perceptions. In order to address consumer requirements during difficult economic times, brands can demonstrate their responsiveness to market trends and consumer preferences by providing economy sizes or other value-driven solutions (Kucher). Brands being able to understand public perception is crucial for building a thriving business. This insight empowers companies to refine brand identity, craft influential marketing initiatives, and adapt promptly to changes in consumer sentiment (Kirsch).

### **3.2) Building brand identity**

Brand identity encompasses more than just visual elements like logos and colors; it also includes a brand's personality, values, and how it's perceived by consumers (Zerkalenkov). It distinguishes a company apart from rivals and encourages strategic and emotional relationships with customers (Wheeler). In the end, creating a memorable brand identity is similar to writing an engaging narrative that connects with consumers; both require consistency, audience awareness, and careful execution (Bradshaw).

A company's brand identity is vital for setting it apart from the competition, creating a lasting impression, and developing real relationships with its clients (Wheeler). Consumers are drawn to experiences, stories, and affiliations above simple goods or services in today's congested market with an abundance of options (Zerkalenkov). A strong brand identity enables a business to tell its narrative, connect deeply with its audience, and foster loyalty and trust (Bradshaw). People who understand a company's story and identify with its principles go beyond being customers to become supporters of the brand, investing in the story and core of the company rather than just its products .

Influencers are essential for developing a brand's identity since they represent the brand's personality, values, and messaging through their content (FasterCapital). Influencers can reinforce brand identification by effectively communicating the brand's story and unique selling factors to their audience through strategic partnerships and collaborations (Davids). Influencers contribute to the development of a unified and genuine brand image that appeals to customers by continuously coordinating their personal brand with the company's (Maren).

Brands should concentrate on several essential influencer characteristics in order to use influencer marketing to successfully establish brand identity. These include authenticity, consistency, target audience alignment, storytelling abilities, and trust and credibility

(FasterCapital). Establishing a true connection with the target audience through influencers who genuinely share the brand's values and views helps strengthen the brand's identity (Marq). Additionally, reinforcing brand identity and establishing a unified brand experience for the audience requires maintaining consistency in messaging, visual aesthetics, and tone of voice throughout various influencer engagements.

In addition, it's critical to select influencers whose interests, preferences, and demographics match those of the brand's target market (Influence Hunter). This alignment guarantees that the brand message is effectively communicated and that the audience finds it appealing. Moreover, strong narrative abilities in influencers can be used to produce captivating content that draws viewers in. Brands may successfully communicate their beliefs and unique selling points by utilizing influencers' storytelling skills. Working with influencers that genuinely connect with their audience and have a history of producing quality content can help the company gain credibility and trust (Armenteras).

### **3.3) Cultural background of influencers**

The term "cultural background" refers to a broad variety of characteristics, such as gender, experiences, ethnicity, and socioeconomic status (Hunt). These factors mold people's actions, values, and beliefs, which in turn affect what they buy. For example, based on religion, age, geography, and status-related subcultures, cultural variables influence preferences for clothes, food, and even color (Management Study Guide). Consumer behavior and tastes are greatly influenced by this cultural background, which directs their purchasing decisions. Incorporating these cultural influences into marketing strategies is essential for effectively engaging diverse audiences and maximizing market potential (Hunt).

The influencer's cultural background plays a crucial role in the success of an influencer campaign through shared cultural themes, nostalgia, credibility, targeted campaigns for specific cultures, relatability and representation, as well as understanding cultural nuances and preferences. Influencers have the ability to capitalize on persistent cultural themes and sentimental episodes that extend through specific age groups and ethnicities. They can establish a more robust emotional bond with a broader audience by arousing pleasant emotions and common experiences (Wiley). Moreover, content creators who are culturally compatible with their target audience have a greater chance of earning the trust and engagement of consumers (Hill). An influencer's perceived authority and credibility on culturally related topics may increase when their cultural identity is congruent with the culture of their audience (Wang).

Furthermore, influencers may employ their own cultural heritage to their advantage by developing ads that speak to particular audience segments. Brand ambassadors who are from similar cultural backgrounds to their target audience, for instance, can provide material that appeals to shared customs, values, and preferences (Wiley). Seeing influencers who share their cultural background can make consumers feel more represented and able to relate to the content. This representation can lead to higher engagement and a stronger connection with the brand (Hill).



Brands need to consider the cultural background of an influencer when aiming to build authentic connections with consumers, ensure alignment with target audience values, execute localized campaigns effectively, navigate cultural nuances, and foster trust and credibility in diverse markets (Punjab). In order to guarantee authenticity and resonance in the influencer's content and messaging with the target audience, brands concentrating on certain cultural markets or segments should select influencers whose backgrounds correspond with those cultures (FasterCapital). Additionally, certain industries or products may be more sensitive to cultural differences in values, beliefs, and norms (Punjab). In these cases, brands should choose influencers who deeply understand the cultural context and can navigate it appropriately (Čechová). Finally, language and communication patterns used in different cultures can have an impact on how effective influencer marketing is. Targeting culturally diverse audiences requires brands to take the influencer's communication style and language proficiency into account (Punjab).

To be able to effectively market to various audiences, brands must have a thorough understanding of cultural subtleties and preferences. In order to traverse these difficulties and produce more relevant and effective advertisements, marketers can work with influencers that have a thorough understanding of the cultural context (Constantinides). The cultural background of an influencer is crucial for certain types of brands and products, thanks to the benefits discussed above.

#### **4) Conclusion**

This review emphasizes the significant connection that exists between UGC and brand impression, especially when it comes to the influencers' cultural backgrounds. UGC's ability to influence brand views varies greatly depending on the cultural setting. Influencers that are culturally similar to their target audience are more likely to provide relatable and genuine content, which raises brand loyalty and engagement. It is crucial for brands to comprehend and take advantage of these cultural quirks as they traverse the complexity of international marketplaces. Influencer programs that are in line with the cultural values and preferences of the target audience help brands build closer relationships, reduce the risk of cultural insensitivity, and produce marketing results that are lasting and more significant.

## Works Cited

- Alzakhravi, Elena. *Four Types Of Social Media Influencers*. 8 May 2022, <https://www.linkedin.com/pulse/four-types-social-media-influencers-olena-alzakhravi>.
- Beaulac, Hugh. "How to Use Social Media for Market Research." *CXL*, 18 Feb. 2019, <https://cxl.com/blog/social-media-market-research/>.
- Beichert, Maximilian, et al. "Influencer Marketing ROI: Research Shows Influencers with Smaller Followings Are More Cost-Effective." *American Marketing Association*, 20 Feb. 2024, <https://www.ama.org/2024/02/20/influencer-marketing-roi-research-shows-influencers-with-smaller-followings-are-more-cost-effective/>.
- Bhasin, Hitesh. "Personal Factors Affecting Consumer Buying Behavior." *Marketing91*, 6 Aug. 2015, <https://www.marketing91.com/personal-factors-affecting-consumer-buying-behavior/>.
- Bradshaw, Ryan. "The Importance of Brand Identity and How to Do It Right." *Apollo Technical LLC*, Apollo Technical, 20 May 2021, <https://www.apollotechnical.com/the-importance-of-brand-identity/>.
- Brand Personality - Brand Influencer Fit*. <https://www.reachbird.io/magazine/en/brand-personality-brand-influencer-fit/>. Accessed 12 May 2024.
- Chacko, Annette. "8 Ways to Use Social Media for Market Research." *Sprout Social*, 30 May 2023, <https://sproutsocial.com/insights/social-media-market-research/>.
- Cultural Factors Affecting Consumer Behaviour*. <https://managementstudyguide.com/cultural-factors-affecting-consumer-behaviour.htm>. Accessed 13 May 2024.
- Dauids, Jon. "Building Brands With Influencer Marketing." *Branding Strategy Insider*, The Blake Project, 21 Feb. 2024, <https://brandingstrategyinsider.com/building-brands-with-influencer-marketing/>.
- dos Santos, Marcelo Luis Barbosa. "The 'so-Called' UGC: An Updated Definition of User-Generated Content in the Age of Social Media." *Online Information Review*, vol. 46, no. 1, May 2021, pp. 95–113.
- "Effective Pricing Strategies in Marketing: Boost Your Business Performance." *My Digital CMO*, 9 Jan. 2024, <https://mydigitalcmo.io/article/pricing-strategies-in-marketing>.
- Fernando, Jason. "Return on Investment (ROI): How to Calculate It and What It Means." *Investopedia*, 25 Nov. 2003, <https://www.investopedia.com/terms/r/returnoninvestment.asp>.
- Garvit. "What Is Brand Perception, How to Measure It, and Why?" *REX Marketing + Design Inc.*, 28 July 2023, <https://startwithrex.com/2023/07/28/what-is-brand-perception-how-to-measure-it-and-why/>.
- Geyser, Werner. "What Is an Influencer? – Social Media Influencers Defined [Updated 2024]." *Influencer Marketing Hub*, 14 Mar. 2017, <https://influencermarketinghub.com/what-is-an-influencer/>.
- Girlboss. "Dogs Are The New Beauty Influencers And They Make More Money Than You."

- Girlboss*, 20 July 2017, <https://girlboss.com/blogs/read/dog-beauty-influencers>.
- Hill, Steve. "The Four Key Influencers of Consumer Behaviour." *Branded Umbrellas | Custom Umbrellas | The Umbrella Workshop*, Umbrella Workshop, 4 Oct. 2021, <https://www.umbrellaworkshop.com/marketing/key-influencers-of-consumer-behaviour/>.
- "How to Boost Your Brand Identity with Influencer Marketing." *Marq*, 14 Dec. 2022, <https://www.marq.com/blog/how-to-boost-brand-identity-influencer-marketing>.
- How You Can Use Influencers to Build Your Brand Identity – Influence Hunter*. <https://influencehunter.com/2022/02/25/how-you-can-use-influencers-to-build-your-brand-identity/>. Accessed 12 May 2024.
- Hunt, Janet. "Cultural Influences on Marketing Strategies." *Small Business - Chron.com*, Chron.com, 2 Oct. 2011, <https://smallbusiness.chron.com/cultural-influences-marketing-strategies-26121.html>.
- IMARC Services Private Limited. *Understanding Generational Differences in Consumer Behavior*. 3 May 2023, <https://www.linkedin.com/pulse/understanding-generational-differences-consumer-behavior>.
- joshuaweatherwax. "4 Proven Strategies to Shape How Consumers See Your Brand." *NIQ*, NielsenIQ, 12 Apr. 2024, <https://nielseniq.com/global/en/insights/education/2024/shape-how-consumers-see-your-brand/>.
- Jovicic, Aleksandra Beka. "How to Find Influencers for Your Brand (Not Just on Instagram)." *Semrush Blog*, Semrush, 10 Nov. 2023, <https://www.semrush.com/blog/how-to-find-influencers/>.
- Kirsch, Katrina. "What Is Brand Perception? How to Measure It and 4 Examples." *HubSpot*, 5 July 2023, <https://blog.hubspot.com/marketing/what-is-brand-perception#article>.
- Mastering Brand Strategies: Build a Strong Brand with Impact*. Simon Kucher, 11 Mar. 2024, <https://www.simon-kucher.com/en/insights/mastering-brand-strategies-build-strong-brand-impact>.
- Niosi, Andrea. "Social Influences." *Introduction to Consumer Behaviour*, BCcampus, 2021. [No Title]. <https://lup.lub.lu.se/luur/download?fileOid=8971191&func=downloadFile&recordOid=8971190>. Accessed 12 May 2024.
- . <https://www.diva-portal.org/smash/get/diva2:1433912/FULLTEXT01.pdf>. Accessed 14 May 2024.
- . <https://www.ijfmr.com/papers/2024/1/14186.pdf>. Accessed 16 May 2024.
- . [https://is.muni.cz/el/econ/jaro2000/SDKZ/Research\\_proposal\\_\\_1\\_.pdf](https://is.muni.cz/el/econ/jaro2000/SDKZ/Research_proposal__1_.pdf). Accessed 16 May 2024.
- Puylaert, Annieke. "The Different Types Of Influencers: How & When To Leverage Their Reach." *M&C Saatchi Performance*, 19 Sept. 2023, <https://www.mcsaatchiperformance.com/news/the-different-types-of-influencers-how-when>

-to-leverage-their-reach/.

Ramya, J., et al. "Influencer Marketing: Evaluating The Impact Of Social Media Influencers On Consumer Behavior." *Migration Letters*, vol. 21, no. S6, Feb. 2024, pp. 1535–46.

rebecca.lee. *Building Trust: 5 Strategies to Boost Brand Credibility*. People Development Magazine, 31 Mar. 2024,

<https://peopledevelopmentmagazine.com/2024/03/31/boost-brand-credibility/>.

Rose, Jessica. *What Is Cognitive Marketing?* <https://www.fitzmartin.com/blog/intro-to-cogmar>. Accessed 12 May 2024.

Sambuno. *Beyond the Price Tag: Exploring the Symbolic Meaning and Future Trends of Consumer Purchasing Behavior*. 4 June 2023,

<https://www.linkedin.com/pulse/beyond-price-tag-exploring-symbolic-meaning-future-trends>.

Sanders, Rob. "The 5 Types of Influencers You Need to Know." *Simplilearn.com*, Simplilearn, 23 Oct. 2020, <https://www.simplilearn.com/types-of-influencers-article>.

Santora, Jacinda. "12 Types of Influencers You Can Use to Improve Your Marketing." *Influencer Marketing Hub*, 3 Dec. 2020, <https://influencermarketinghub.com/types-of-influencers/>.

Tlapek, Jake. "Understanding Customer Value Proposition's Impact On Brand Perception." *Wizard Marketing*, 22 Apr. 2024,

<https://thewizard.marketing/understanding-customer-value-propositions-impact-on-brand-perception/>.

*Website*.

[https://www.researchgate.net/publication/221017572\\_Effects\\_of\\_Cultural\\_Background\\_on\\_Internet\\_Buying\\_Behaviour\\_Towards\\_a\\_Virtual\\_Global\\_Village](https://www.researchgate.net/publication/221017572_Effects_of_Cultural_Background_on_Internet_Buying_Behaviour_Towards_a_Virtual_Global_Village).

Wheeler, Kathryn. "Brand Identity: How to Develop a Unique & Memorable Brand in 2023." *HubSpot*, 10 May 2023, <https://blog.hubspot.com/agency/develop-brand-identity#article>.

Wiley, Danielle. "Nostalgia: A Secret Weapon For Influencer Marketing Success." *Forbes*, 6 June 2023,

<https://www.forbes.com/sites/forbesagencycouncil/2023/06/06/nostalgia-a-secret-weapon-for-influencer-marketing-success/>.

Worb, Jessica. *14 Types of Social Media Influencers*. Later Blog, 30 Nov. 2023,

<https://later.com/blog/types-of-social-media-influencers/>.

YEC. "Five Steps For Finding The Right Influencer For Your Brand." *Forbes*, 28 June 2022,

<https://www.forbes.com/sites/theyec/2022/06/28/five-steps-for-finding-the-right-influencer-for-your-brand/>.

Zerkalenskova, Zhenya. "Brand Identity: What It Is and How to Create a Strong One." *Semrush Blog*, Semrush, 10 Jan. 2023, <https://www.semrush.com/blog/build-brand-identity/>.

# Gender Bias in Machine Learning and Language Models Anya Gupta

## Abstract

Bias exists in various forms at various stages in machine learning (ML) models. This bias can lead to inaccurate and harmful results and outputs. As such, identification and mitigation against bias should be prioritized. The paper first introduces machine learning with a specific focus on language models. Next, the review explores concepts of bias in machine learning while examining techniques for identifying and mitigating the bias. Finally, a case study is utilized to explore bias in ML datasets and the effects of possible mitigation approaches.

## Keywords

Robotics And Intelligent Machines; Machine Learning (ML); Bias; Natural Language Processing (NLP); Underrepresentation.

## Introduction

Machine learning (ML) is a term used to describe the use of algorithms to process and “learn” from large amounts of data. ML differs from rule-based programming in that instead of being explicitly programmed, it learns from the input data and makes predictions.<sup>1</sup> As shown below, ML algorithms can be categorized into distinct types based on their purpose and method of fulfilling that purpose.

Supervised learning is a type of ML involving a dataset inputted into an ML algorithm where the desired output is known to verify the accuracy of an ML algorithm’s outputs. Unsupervised learning is a machine learning type similar to supervised learning, but the output is not known. It can be quite useful when detecting anomalies. Other types of machine learning include Reinforcement Learning, Semi-Supervised Learning, and Self-Supervised Learning.<sup>2</sup> Natural Language Processing (NLP) is a type of ML that teaches machines to analyze text and human speech and convert the data into a desired output format.<sup>1</sup> Some examples of NLP are speech recognition, speech-to-text, text-to-speech, and grammatical tagging, which is how an NLP model identifies what part of speech a word is. For example, the word “run” can be a noun in one context (such as “I am going for a run”) or a verb in another (“I am going to run to the store”).<sup>3</sup>

NLP can even go so far as to summarize large portions of text into a smaller version a human can easily read through.<sup>3</sup> Based on its knowledge of human speech and writing; the NLP model can pick out the most important parts of a paper. Although these machines can proficiently replicate human speaking patterns, they may also replicate their biases. This paper discusses how and where biases can be found and how to mitigate them. It also includes a case study that reviews some of the metadata for COVID-19 patients whose data was used by scientists to make predictions about COVID-19.

## Discussion

### I. Identification of Bias in Models

Bias is the preference of one group, being, or even object over another in an inappropriate situation. Bias in AI, or preferences in an ML algorithm or dataset that skew results, can even be found in important algorithms that can aid in determining the fate of one's life or well-being. This paper primarily focuses on gender bias, the preference of one gender over the other. Gender bias can be present in various parts of NLP systems, including algorithms, training data, and pre-trained models.<sup>4</sup> It also touches on biases against certain age groups and races.

Problems with bias can occur during data collection. Bias is common in ML algorithms where there is an underrepresentation of a specific gender, race, or other group in the training data. Collecting data associated with sensitive or minority groups in proportions appropriate for its purpose can prevent bias from accumulating in the data. If this data is not added, the algorithm will not know about these groups and will be unable to produce fair results.<sup>5</sup> However, after this, a de-biasing method may also be needed.

Several methods can be utilized to identify bias in an ML algorithm. One method is the use of psychological tests on AI, which can include the association of words with genders used on the ML algorithms to see if they contain any bias against a particular gender.<sup>4</sup> Another tool that can be utilized to detect bias is crowdsourcing, the practice of collecting large amounts of data and annotation from a large group. Crowdsourcing can be effective because many people would be looking at one dataset, and it will be difficult to notice data that generates or propagates bias.

Dataforce<sup>3</sup> states listening to feedback can effectively mitigate bias in an ML algorithm.<sup>6</sup> Crowdsourcing can also be a way to collect a large amount of data quickly. Additionally, in cases where one has a diverse set of people from whom they collect the data, there will be varied perspectives and less bias as opposed to data collected from a group of people with little to no diversity so that many fewer perspectives will be ignored.<sup>7</sup>

COMPAS (Correctional Offender Management Profiling for Alternative Sanctions) is an ML algorithm that aids in deciding whether or not a criminal can become a "recidivist" - a criminal who, after being released from jail, re-offends. This algorithm favors white defendants over black defendants, as shown in Figure 1 below. With this bias in place, black defendants might be falsely labeled as people who will most likely become recidivists and fail to achieve the freedom they deserve.<sup>8</sup> In Figure 1, the data for black defendants are considerably more evenly distributed along the scores than white defendants, which is heavily skewed to the more miniature scores (less likely to re-offend). In addition, black defendants were wrongly expected to re-offend almost twice as much (45% vs. 23%) as their white counterparts, but white defendants were wrongly predicted to not re-offend almost twice as much (49% vs. 28%).<sup>8</sup>

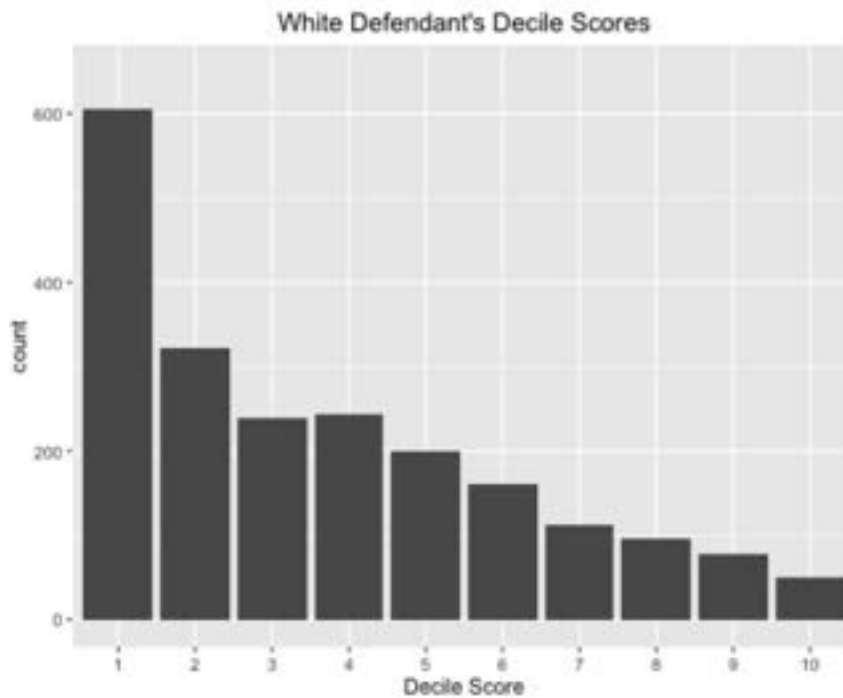
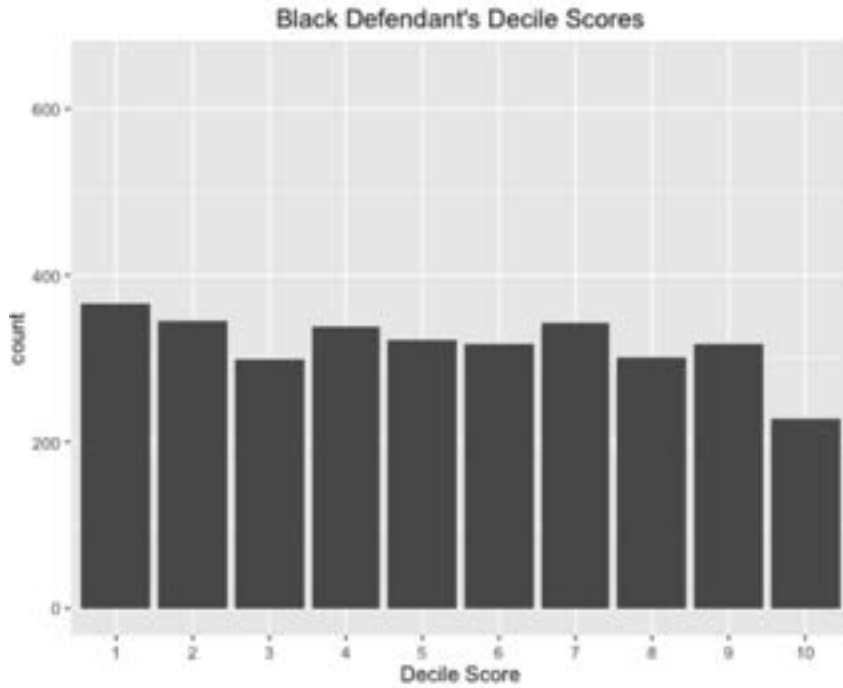

Figure 1. These images from propublica.org, an independent newsroom, depict the “decile scores” or a person's probability of re-offending. Smaller decile scores mean that a criminal is less likely to re-offend, and a larger one means they are more likely to re-offend.<sup>9</sup> The black defendants’ data are more evenly distributed among the scores, while the white defendants’ data are mostly towards the left, creating the perception of them being less likely to re-offend.

Bias can also be found in U.S. healthcare: a heavy bias for white patients and against black patients was found in an algorithm designed to determine whether or not a patient required additional medical help.<sup>9</sup> However, race was not even a factor considered by the algorithm. Healthcare cost history, a variable closely correlated to race, was considered instead and was typically lower for black patients due to a variety of reasons. This led to the algorithm inferring that black patients needed less additional healthcare than white patients due to it internalizing the misconception that a higher healthcare cost history is indicative of a higher number of healthcare needs. Subsequently, researchers worked to reduce the bias by 80%, but the bias would have persisted without this effort.<sup>8</sup>

Data collectors who create ML datasets should consider including data from underrepresented communities more equally. If such measures are not taken, other programs implementing these models will unknowingly implement the bias. Eventually, the bias propagates through the ML algorithm and other systems that use it. However, mitigating or eliminating the bias at its source would prevent the worsening of the bias. ML algorithms have a similar problem. While ML algorithms, particularly language models, do not have biases, they reflect the biases of the programmers who build them. If those training language models do not come from diverse backgrounds or are not educated on correctly identifying bias, the problem of existing bias could worsen.<sup>10</sup>



Figure 2. When provided with the prompt “Manager” this ML algorithm created images only of white men.<sup>11</sup>

The bias against women in ML algorithms and datasets is a widely explored topic. To avoid male-dominated decisions and leadership in the technology fields, an increase in gender diversity has been proposed, especially in the decision-making systems involving AI.<sup>12</sup> Well-known systems such as Facebook’s job ads and Amazon’s “AI-based decision-making system for recruitment” (subsequently discontinued) contain gender bias.<sup>12</sup> Additionally, as shown in Figure 2, the prompt “manager” was provided for an ML algorithm, creating images only of men. However, like most problems, there are ways to fix gender bias in AI.



## Causes and Mitigation of Bias in AI

For bias to be mitigated or eliminated, it must be identified first. For example, IBM released software that can aid in detecting and eradicating bias called AI Fairness 360.<sup>13</sup> It “consists of loading the data into a dataset object, transforming it into a fairer dataset, applying fair pre-processing algorithms, learning classifiers from transformed datasets, and obtaining prediction from the classifier.” In simpler terms, it collects the data, puts it all into a dataset so it can run properly, transforms it into a less biased dataset, applies algorithms that remove or reduce bias on the data and tries to predict the outcome of the data.

A commonly utilized tactic to mitigate bias is fine-tuning, the process by which an ML algorithm trained using biased training data gets “retrained” on an unbiased dataset to remove the bias.<sup>4</sup> Another way bias can be mitigated is through gender tagging, where the input is “tagged” with a gender.<sup>4</sup> For example, “I’m happy” would change to “MALE I’m happy” if the speaker is male. Then, the algorithm will know the gender of the speaker and will make many fewer mistakes.<sup>4</sup> While it may appear to propagate bias, it gives the algorithm a better understanding of certain words that have to be associated with genders, such as “man,” “woman,” “businesswoman,” and “businessman.”

Another method used, particularly for NLP models, is de-biasing word embeddings. Word embeddings are words shown in a vector space that represent how close a word’s meaning is to another’s.<sup>4</sup> These word embeddings can be crucial in mitigating bias, as they are a fundamental part of many NLP systems. When these are de-biased, NLP systems bring certain words closer to each other and farther away from the gendered words (such as he, she, etc.). This movement away from gendered words causes words not to be associated with genders and the NLP models will not assume attributes about a person based on their gender or vice versa.<sup>4</sup> Unbalanced datasets are a common cause of ML problems; they create bias due to underrepresentation. Occasionally mixing different datasets increases the amount of data in a dataset and avoids unbalanced datasets (which happen from a lack of data). This technique also allows a greater variety of data to be included in the dataset, which could aid the model in generalizing better. However, there may be better options.

According to Arias-Garzón *et al.*,<sup>14</sup> scientists and doctors use chest X-rays to check if a patient is COVID-positive. In the early stages of COVID-19, there were very few images of COVID-19-positive chest X-rays. Because of this, scientists looked to mix datasets to obtain an ample amount of data. As expected, there was variety in the images. However, this variety led the ML algorithm to focus on the differences within the COVID-19 positive images instead of the differences between the images used as the control and the COVID-19 images. Having a diverse team can lead to diversity in the datasets (due to the varied perspectives coming from distinct backgrounds), and “ML algorithms are only as good as the data on which they’re trained”.<sup>15</sup> If the data that the ML algorithm is trained on is not diverse, the algorithm will not produce an effective and fair output due to the exclusion of certain groups. As stated in orioresults.com, a data analytics and management firm, having a more diverse data collection team makes it necessary for team members to discuss issues and include multiple points of view

in the algorithm, preventing the “mindset” of the ML from having a limited perspective.<sup>16</sup> Data collection teams can be trained to recognize this bias and mitigate or, if possible, eliminate it. That was only one of the many ways data manipulations can be utilized to minimize the bias in a dataset. A different method, discussed by Sun *et al.*, was swapping all the gendered words in a dataset with the corresponding word of the opposite gender (i.e., “he” becomes “she,” “his” becomes “her,” etc.), adding the gender-swapped dataset to the original dataset and making an augmented dataset. This expanded dataset had an equal amount of data for each gender. Because of this, underrepresentation cannot occur in the data because there is essentially the exact data for each. However, this cannot work for datasets containing sentences such as “she gave birth” because the sentence “he gave birth” does not make sense. Gender tagging and bias fine-tuning are two examples where a program's data is changed to remove the bias.

Yet another method is gender-swapping, where the genders used in statements in the training data are swapped (male turns into female, female turns into male). The ML algorithm is then trained on this new data and learns to associate some words with both genders, thus disassociating words from gender entirely. However, this may not work with words such as “businessman” and “businesswoman,” which must be associated with different genders. The genders will be kept the same.<sup>4</sup>

Manipulating data to reduce bias is a technique a computer program can utilize. For example, a program could alter weights and increase the significance of data belonging to underrepresented communities. An implementation of this in a program would be built specifically to eliminate underrepresentation by increasing the weights of the people in the data to match the population that the sample data was taken from. For example, if the data was taken from a town with a 40% female population but only had 20% females in the data, the program would alter the weights so that the female data accounts for 40% of the data.

## **II. Case Study: Quantifying Potential Bias in Data**

This case study operationalizes a method to create augmented datasets. Originating in December 2019, the COVID-19 virus caused a worldwide pandemic by March 2020. The leading diagnostic test for COVID-19, RT-PCR (Reverse transcription-polymerase chain reaction) is very effective, but alternative methods were sought due to high cost and long processing time. Scientists turned to using chest X-rays for diagnosis, and for this purpose, a series of datasets of chest X-ray images were collected. To make these diagnoses faster, ML models were employed to make decisions on these datasets. However, it became evident that the datasets were biased and improvements were necessary. Below are three datasets used in the case study.<sup>14</sup>

Dataset name	Subjects	Metadata
Cohen	332	Sex-(Image Amount), Age-(Included), Location-(Europe>Others), Dates-(Included), Others-(ICU admission-Survival model).
AlforCOVID	Not mentioned	Sex-(Image amount), Age-(Included), Location-(Not specified), Dates-(Not mentioned), Other-(ICU admission, Death and Prognosis).
Figure 1 Covid-19 Chest X-ray dataset	48	Sex-(Image amount), Age-(Included), Location-(Not specified), Dates-(Not included)

Table 1. This table lists the datasets discussed in this case study.<sup>14</sup>  
The below metadata (Figure 3) illustrates possible imbalances in the data.

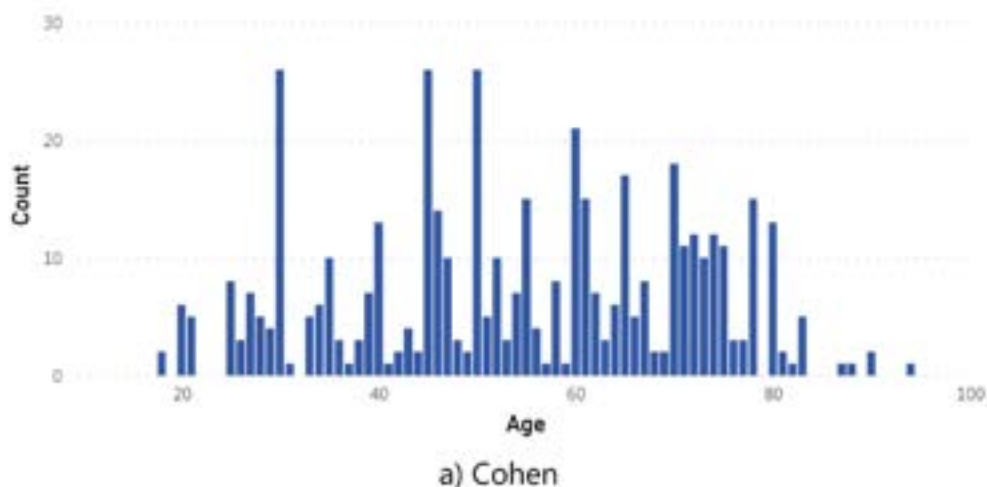

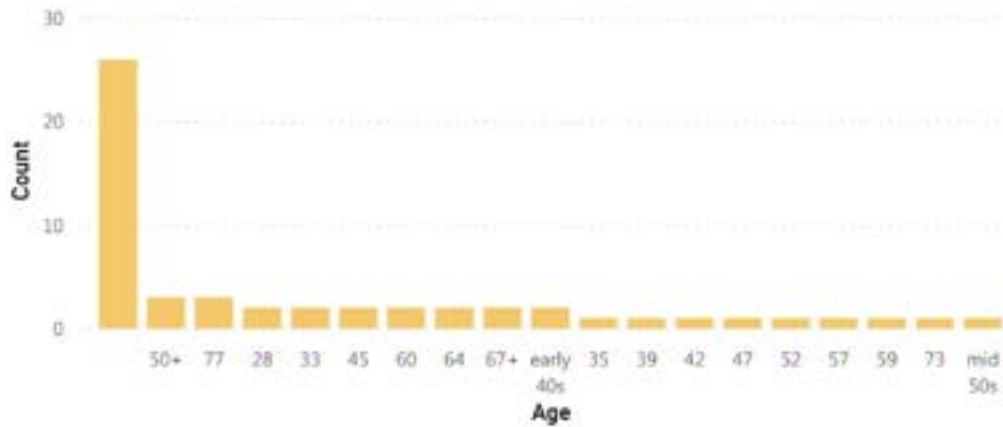

b) Figure 1

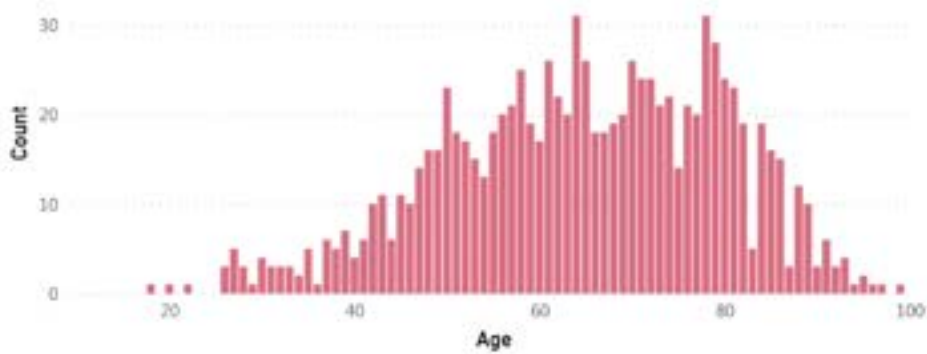

c) Alfor (Except Hospital D)

Figure 3. As seen in these three images,<sup>14</sup> the data distribution in the datasets could be better for specific algorithms where age matters. A and C show a bias in terms of age, with some ages being more represented than others. B shows a relatively small amount of bias in the data (the first column is where the age was left blank).

### Conclusion

In conclusion, bias is prevalent in ML algorithms and datasets in various forms: gender bias, age bias, etc. However, several options exist to identify, alert against, mitigate, and possibly wholly eradicate this bias to obtain a fair and unbiased algorithm that does not produce harmful outputs. Examples include gender-swapping to create an augmented dataset, gender tagging to ensure the ML algorithm will not misgender a speaker, and de-biasing word embeddings. However, gender-swapping, although helpful in creating a dataset with a significantly smaller bias, may not be a viable method to de-bias datasets due to some words or contexts only applying to one gender. There are even tools, such as “AI Fairness 360” and “What If,” used professionally to find and eliminate bias in programs and datasets.

While gender bias, age bias, and other types of biases are quite prevalent in ML data and algorithms, the issue has been acknowledged, and tools are being developed to identify and remove the bias.

### **Acknowledgments**

I would like to thank my mentor, Cyrus Ayubcha, for guiding my research.

### **Author Bio**

Anya Gupta is a sophomore at Lexington High School, Massachusetts. She is passionate about math, science, creative writing, and computer science, specifically artificial intelligence and machine learning. She has a nonprofit promoting educational equity and has conducted several projects to benefit other nonprofits.

## Works Cited

1. Overview of Artificial Intelligence Technology | FINRA.org. (2013). Retrieved August 10, 2023, from Finra.org website:  
<https://www.finra.org/rules-guidance/key-topics/fintech/report/artificial-intelligence-in-the-securities-industry/overview-of-ai-tech>
2. Brownlee, J. (2019, November 10). 14 Different Types of Learning in Machine Learning - MachineLearningMastery.com. Retrieved July 31, 2023, from MachineLearningMastery.com website: <https://machinelearningmastery.com/types-of-learning-in-machine-learning/>
3. What is Natural Language Processing? | IBM. (2023). Retrieved August 11, 2023, from Ibm.com website: <https://www.ibm.com/topics/natural-language-processing>
4. Sun, T., Gaut, A., Tang, S., Huang, Y., ElSherief, M., Zhao, J., Mirza, D., Belding, E., Chang, K., & Wang, W. Y. (2019). Mitigating Gender Bias in Natural Language Processing: Literature Review. *ArXiv*. /abs/1906.08976
5. 4 Ways to Address Gender Bias in AI. (2019, November 20). Retrieved July 25, 2023, from Harvard Business Review website:  
<https://hbr.org/2019/11/4-ways-to-address-gender-bias-in-ai>
6. 3 Ways to Minimize AI Bias | TransPerfect. (2022, October 11). Retrieved July 30, 2023, from Transperfect.com website:  
<https://www.transperfect.com/dataforce/blog/3-ways-to-minimize-ai-bias>
7. Clive Reffell. (2023, March 28). Why is Crowdsourcing Vital to Make AI Smarter? Retrieved July 31, 2023, from Crowdsourcing Week website:  
<https://crowdsourcingweek.com/blog/crowdsourcing-makes-ai-smarter/#:~:text=Also%2C%20crowdsourcing%20makes%20AI%20smarter,used%20to%20improve%20the%20system.>
8. Shin, T. (2020, June 4). Real-life Examples of Discriminating Artificial Intelligence. Retrieved August 2, 2023, from Medium website:  
<https://towardsdatascience.com/real-life-examples-of-discriminating-artificial-intelligence-cae395a90070>
9. Larson, Julia, J. (2016, May 23). How We Analyzed the COMPAS Recidivism Algorithm. Retrieved August 2, 2023, from ProPublica website:  
<https://www.propublica.org/article/how-we-analyzed-the-compas-recidivism-algorithm>
10. AI Bias - What Is It and How to Avoid It? (2022). Retrieved July 31, 2023, from Levity.ai website:  
<https://levity.ai/blog/ai-bias-how-to-avoid#:~:text=Machine%20Learning%20bias%2C%20also%20known,of%20the%20Machine%20Learning%20process.>
11. Heikkilä, M. (2023, March 22). These new tools let you see for yourself how biased AI image models are. Retrieved July 31, 2023, from MIT Technology Review website:  
<https://www.technologyreview.com/2023/03/22/1070167/these-news-tool-let-you-see-for-yourself-how-biased-ai-image-models-are/>

12. Nadeem, A., Marjanovic, O., & Abedin, B. (2022). Gender bias in AI-based decision-making systems: a systematic literature review. *Australasian Journal of Information Systems*, 26. <https://doi.org/10.3127/ajis.v26i0.3835>
13. Verma, A. (2021, January 27). Guide to AI Fairness 360: An Open Source Toolkit for Detection And Mitigation of Bias in ML Models. Retrieved July 30, 2023, from Analytics India Magazine website:  
<https://analyticsindiamag.com/guide-to-ai-fairness-360-an-open-source-toolkit-for-detection-and-mitigation-of-bias-in-ml-models/#:~:text=It%20consists%20of%20loading%20the,%2C%20transformed%2C%20and%20predicted%20datasets.>
14. Arias-Garzón, D., Reinel Tabares-Soto, Bernal-Salcedo, J., & Ruz, G. A. (2023). Biases associated with database structure for COVID-19 detection in X-ray images. 13(21).  
<https://doi.org/10.1038/s41598-023-30174-1>
15. Contreras, E. (2023, April 12). The Importance of Diversity in AI. Retrieved July 30, 2023, from The 3rd Eye website:  
<https://www.the3rdeye.com/the-importance-of-diversity-in-ai-and-the-consequences-of-ignoring-it/#:~:text=Machine%20learning%20systems%20are%20consistently,are%20fed%20diverse%20data%20sets.>
16. Holler, M. (2022, January 10). Diversity, Inclusion & Equity: How to Beat Data Bias - ORI. Retrieved July 28, 2023, from ORI website:  
<https://www.oriresults.com/articles/blog-posts/diversity-inclusion-equity-how-to-beat-data-bias/#:~:>
17. Boyle, T. (2018). Medical Transcriptions. Retrieved August 11, 2023, from Kaggle.com website: <https://www.kaggle.com/datasets/tboyle10/medicaltranscriptions>

# **Enhancing Sustainability and Efficiency of Express Delivery Services in China: Oversight and Integration by Chengrui Yu**

## **Abstract**

China's express delivery industry has grown rapidly in the last few decades as e-commerce has risen in popularity and massive consumer demand has been seen. Meanwhile, the supervision and management of universal service obligation impose great pressure on the government postal system cost recovery. Therefore, this paper attempts to explore the ways for enhancing the efficiency and sustainability of China's delivery industry. The results show that there is great potential to improve the service quality and efficiency through strengthening the regulatory framework and optimizing the market integration of postal and express delivery services.

## **Introduction**

The delivery industry is a crucial part of the logistics sector. It forms the backbone of the economy by facilitating the flow of goods and services (Rouse et al., 2018; Liu et al., 2024). According to earlier research, effective delivery services are key to accelerating the flow of economic development, because they improve business productivity, reduce costs, and improve customer satisfaction (Rabinovich & Knemeyer, 2006). They help enterprises to run normal business activities and deliver products to the users in a convenient and reliable manner. This is especially important given the rapid expansion of China's e-commerce market. Additionally, the development of an efficient delivery industry has a vital effect on the rough and remote areas (Rouse et al., 2018). In many regions of China, especially some underdeveloped and poor areas, the residents and businesses there usually lack access to efficient delivery services. Therefore, improving delivery infrastructure in these locations can guarantee the businesses and the consumers to get the same goods and services as the developed areas. Ultimately, it will promote the comprehensive economic development of the country, narrow the economic gap between urban and rural areas, and provide strong support for the construction of balanced regional development (Gu et al., 2008).

Efficient delivery industry can also enhance the overall competitive edge of Chinese businesses in the international market. With China's further expansion in international trade and becoming the world's largest trade hub, efficient delivery industry is the key to attracting international capital to enter and exit, as well as import and export commodities. It ensures the rapid flow of goods, preventing the goods from being wasted or damaged, and meeting the rigorous requirements of the partners (Salawu & Ghadiri 2022). Mature and robust delivery industry can deal with the complicated international logistics, shorten the transportation cycle, avoiding the risk of lagging and loss, smoothly carrying out the import and export business, and maintaining China's image as a reliable partner. Businesses can obtain new sources of income, and a large number of operators will also be employed in the long run. With the development of



China's economy towards the high level, improving the delivery industry's efficiency will be the key to China's long-term economic growth.

### Global Express and Postal Industry Growth

The delivery industry is broad and covers multiple services and activities pertaining to the carrying and sending of products and letters from one place to another. The main elements of the delivery industry consist of the postal systems and the express systems. The postal systems are the traditional mail services provided by national postal operators, dealing with letters, postcards and minor parcels. Meanwhile, express delivery systems include firms providing quick delivery alternatives, such as within the day, overnight and 2-day delivery services. Examples include UPS, FedEx and DHL. This paper mainly deals with these two delivery services. From 2022 to 2023, the global express parcel market showed a positive development trajectory, evident in the express delivery business volume and income across nations worldwide. Figure 1 illustrates the global shipping and delivery package volume share from 2018 with projections extending to 2028. It clearly shows a significant and steady increase in volumes over the years. According to the "Global Postal Industry Preliminary Report" issued by the International Postal Corporation (IPC, 2023), the aggregate volume of global express parcel business surged to approximately 189.2 billion units, a year-on-year growth of about 9.8% in 2022. The corresponding revenue was about 4.1 trillion yuan, a year-on-year growth of about 12.2%. This growth is mainly driven by emerging markets, which push the global express parcel market towards both stability and expansion.

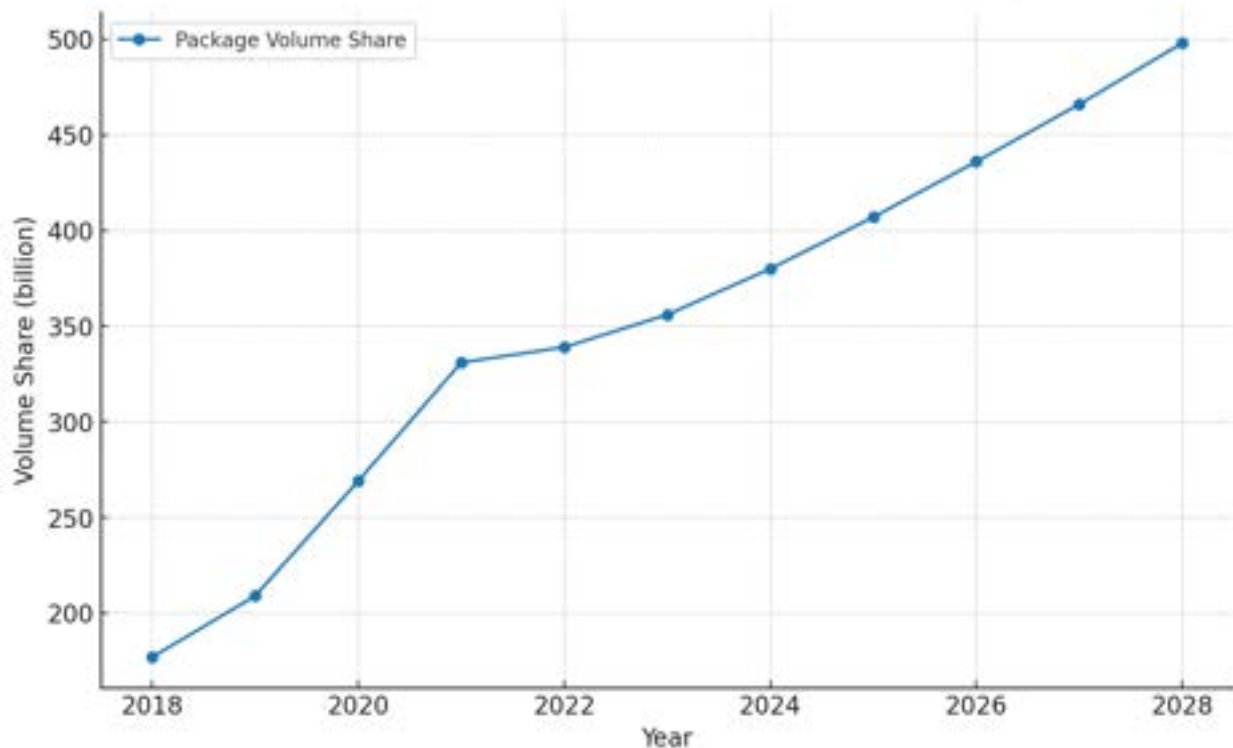

Figure 1. Global Shipping and Delivery Package Volumes (2018-2028)

Moreover, it is estimated that the global express parcel market size by 2024 will be over 200 billion pieces. The revenue will be 4.3 trillion yuan, a growth rate of more than 6%. North America and Europe are expected to return to the long-term growth rate of about 5%, while the Asia-Pacific area remains the fastest growing market for global express delivery. In addition, the Latin American delivery market is expected to explode, with the Brazilian and Mexican market being the key to its development. The Middle East and Africa are still in the stage of forming a relatively small market, but the future growth rate could be very large.

In the field of postal industry, the average revenue of postal enterprises in the first half of 2022 was down 1.5% year on year. However, the overall operational capacity of the industry has been maintained. The main reason is the continuous impact of the global epidemic. Notably, postal enterprise revenue surged by 3.9% in 2021. This shows that the postal industry can adapt to the impact of various adverse factors and move towards stability and development. While the preliminary report overlooks the US\$57 billion windfall the USPS stands to gain from legislative reforms in 2022, it can be predicted that the global postal industry will have a greater impact on future development.

With the continuous development of new technologies and the competition in the market, we can expect that the global express delivery industry and the postal industry will continue to grow and make greater contributions to global economic integration. The advancements will create new development opportunities in various sectors and promote a more interconnected global economy. Countries around the world will benefit from the positive impact on economic growth and development.

### **History and Current Situation of Postal Service in China**

The original purpose of the postal service was to deliver and exchange information, promoting mutual communication and progress through the dissemination of information (Purcell 2016). Over time, this role has expanded beyond just delivering letters and documents. Nowadays, the postal service has transitioned to focus more on facilitating commercial transactions and delivering packages. Additionally, by connecting people from different regions and backgrounds, it helps to promote understanding across communities. This multifaceted role highlights its importance not only in economic activities but also in strengthening social and cultural ties.

As one of the country's important infrastructures, China's postal service has a long history and important social significance (Margit & Wang 2015). The history of China's postal service can be dated back to ancient times, when post stations were the main means of transporting documents, letters and goods. As society evolved, the postal industry has also developed and gradually transformed into a comprehensive communications and logistics network covering the entire nation. In modern times, China's postal service has undergone many reforms and

improvements, continuously enhancing service quality and expanding coverage. Key milestones in the history is summarized in Table 1.

Table 1. Key Milestones in the History of the Chinese Postal Service

<b>Year</b>	<b>Event</b>
1980	Launched international postal express delivery service.
1985	Established China Express Service Company, the first professional express delivery company in China.
1994	Implemented online mail tracking nationwide.
1995	Founded China Postal Airlines, the first all-cargo airline in China.
1999	Initiated the establishment of the Universal Postal Union EMS cooperative body.
2001	Launched domestic express parcel service.
2003	Established China Postal Logistics Company, one of the earliest in contract logistics.
2006	Opened the Nanjing Postal Express Logistics Air Distribution Center, the largest in Asia.
2008	Integrated nationwide express and logistics services, establishing China Postal Express & Logistics Company.
2010	Completed shareholding reform, establishing 'China Postal Express & Logistics Co., Ltd.'
2013	Introduced a dynamic routing and scheduling system for better efficiency.
2015	Started providing bonded warehousing services.
2018	Revenue surpassed 200 billion yuan.
2020	Launched next-generation intelligent logistics services driven by AI technology.
2021	Expanded international logistics network, covering over 200 countries.
2022	Achieved 100% renewable electricity usage in all operations.

The 1980s marked a pivotal period for China's postal services. On July 15, 1980, China introduced international express mail service, laying the foundation for the country's express delivery industry. Four years later, in April 1984, domestic express mail service commenced, offering rapid and dependable services for domestic and international business transactions. The establishment of China Express Service Company on December 3, 1985, signaled the nascent development of China's express delivery industry, gradually forming its own industrial framework. Over the ensuing years, China Postal Service steadily broadened its business scope and improved service standards, emerging as a vital pillar supporting China's economic and social progress.

From the 1990s through the 2000s, China's postal service experienced rapid expansion. On January 18, 1994, China achieved online tracking and inquiry of mail, ushering in the information age for China Post. The establishment of China Postal Airlines on November 26, 1995, provided an extensive air network for postal service coverage across China. Subsequently,

China's postal services began venturing into the international arena, collaborating with global postal entities to offer international express delivery services.

Since the 2000s, China's postal service has entered a new phase of comprehensive development. China Post initiated direct delivery services and domestic express parcel services, further diversifying its business portfolio. Collaborating with international postal organizations, China Post standardized international EMS service protocols, enhancing the efficiency and effectiveness of international postal operations. Additionally, China Post actively expanded into logistics services, offering value-added solutions such as warehousing and freight forwarding, thereby providing customers with comprehensive logistics solutions.

Over the past decade, China's postal industry has experienced rapid development and significant modernization. According to the latest data released by China Post, the national express delivery business volume is expected to exceed 60 billion pieces in 2024, marking a year-on-year increase of more than 10%. Figure 2 illustrates the parcel volumes handled by the Chinese postal service from 2018 to 2023. The data points reflect a significant and consistent increase in parcel volumes over the years, indicating the rapid growth of the postal service in China. These figures highlight the substantial improvement in service capabilities and the expanding business scale of China's postal industry. The growth in business volume underscores the industry's capacity to manage increasing consumer demand efficiently. The substantial increase in express delivery volumes is a testament to the industry's adaptation to these changing market dynamics.

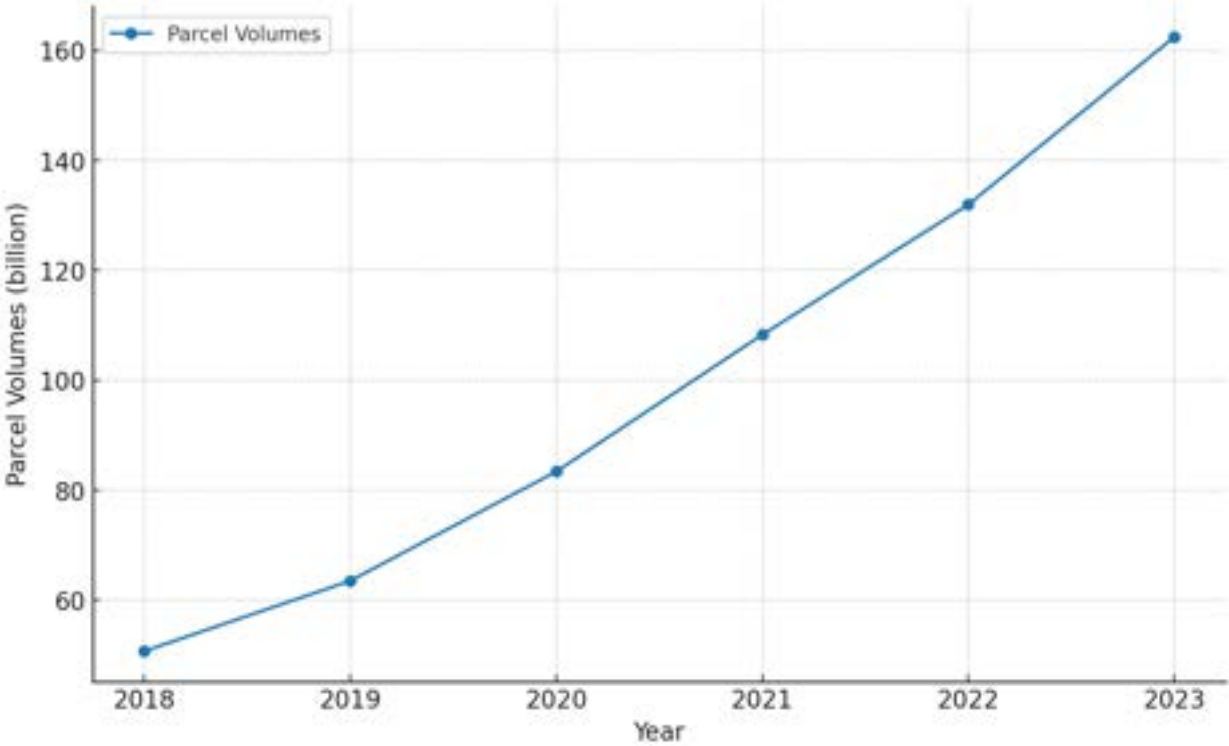

Figure 2. Chinese Postal Service Parcel Volumes (2018-2023)

China's postal industry has made remarkable progress in modernizing its facilities and technology. China Post has invested heavily in building modern express delivery centers and sorting centers, integrating advanced automation equipment and robotics technology. These investments have significantly improved processing efficiency and accuracy, enabling the industry to handle larger volumes with greater speed and precision. Additionally, China Post has strengthened its information technology infrastructure, providing consumers with a range of convenient services such as online ordering, inquiry, and tracking. These IT enhancements have streamlined operations, improved transparency, and increased customer satisfaction by meeting consumers' needs for efficiency and convenience.

Through continuous reform and innovation, China Postal Service has not only improved service quality but also expanded service coverage. It has become a vital driving force for China's economic and social development, delivering reliable and efficient postal services to the public and various industries. Despite these advancements, China's postal industry faces increasing market competition. The growth of e-commerce and rising consumer demand have made the express delivery and logistics industry a highly competitive arena. Numerous domestic and foreign express delivery companies have entered the Chinese market, intensifying competition.

This heightened competition poses several challenges for China Post. First, the traditional postal business has been impacted, necessitating continuous adjustment and upgrading of service models to remain competitive. Second, the rapid development of the express delivery industry has led to environmental and logistical issues, such as the disposal of delivery waste and traffic congestion. Addressing these challenges requires China Post to strengthen its environmental protection measures and traffic management strategies to promote sustainable industry development.

### **Contrast between Express Delivery and Postal Services**

The major difference between express delivery and postal services is the nature of their basic operations, which mirrors their respective social roles and structures (Zhu, 2014; Sage 2017). Express delivery services and universal postal services are, in essence, socially different: One is private delivery by commercial enterprises, the other is public delivery by entities driven by government mandate. The postal service, including the delivery of letters and documents, is designed to provide all citizens with universal and affordable means of communication. It can be viewed as a public good. Express delivery, on the other hand, is a commercial activity supplied by private enterprises to the industrial and commercial sector. It is driven mainly by the demands of a market economy for personalized, time-critical deliveries.

The difference between the two delivery services covers many areas and highlights the different operational nature of each (Sage 2017). Postal services mainly deal with personal correspondence and parcels, while reaching out to the wider population to fulfill their communication needs. Express delivery services, however, focus on the movement of business

documents, information, and small parcel items. They specialize in servicing the economic and trading needs of clients.

Another major difference is that postal services are geared to inclusivity, serving the entire spectrum of society with basic communication tools. For example, they deliver letters, bills, and postcards to urban and rural areas alike, ensuring that all individuals, regardless of location or socioeconomic status, have access to essential mail services. Express delivery services, on the other hand, address the diverse needs of businesses and institutions. They offer customized solutions such as same-day delivery for urgent documents, specialized handling for fragile items, and bulk shipping options for e-commerce companies.

Operationally, universal postal services emphasize uniformity and consistency, striving for standard delivery conditions throughout the system. They maintain regular delivery schedules and standardized rates for sending letters and packages, providing predictable and reliable service to all users. Express delivery services emphasize responsiveness, focusing on rapid reaction to the specific needs of the individual. For example, they offer expedited shipping options like overnight delivery, provide real-time tracking updates, and customize delivery times to suit the recipient's schedule.

The difference in the delivery channel of each service highlights their different operating models. Postal services use a vast network of post offices, maximizing access and territory coverage. Express delivery services, on the other hand, often use proprietary delivery networks or contract with air freight forwarders to ensure fast pickup and delivery of items, both domestically and internationally.

Pricing strategy also differs between the two types of services. Postal services employ standardized tariffs that are generally low in price and are set by national postal unions on behalf of member countries. Express delivery prices tend to be market driven and variable, with carriers striving for better and faster service in response to demand.

The business structure and operation of the enterprise also differs. Postal services are public utilities, sustained and supported by governments to assure stability and prevent bankruptcy. Express delivery firms must succeed in a competitive market and rely on their own resources for profitability.

Regulatory bodies that oversee services also differ. Universal postal services are monitored by postal departments which regulate and oversee postal operations to assure compliance with standards and guidelines. Express delivery services are subject to market regulations and competition policies that assure fair competition and efficient, effective operation.

Finally, the national policy towards each type of enterprise reflects significant difference. Postal firms are afforded a wide range of government subsidies and preferential policies to ensure they can meet their universal service obligations. Express delivery firms enjoy no special support from governments and must succeed in an environment of fair competition, assuring market efficiency and competitiveness.

In summary, the difference between postal and express delivery services reflects distinctions in many areas, highlighting their respective roles, operating models, and contributions to the social and economic infrastructure in which they operate. Table 2 outlines the main differences between express delivery and postal services in different respects. The awareness of these differences helps both corporations and consumers to select the optimal delivery choice for their respective needs.

Table 2. Comparison of Express Delivery and Postal Services

<b>Aspect</b>	<b>Express Delivery Service</b>	<b>Postal Service</b>
Nature of Service	Private service provided by commercial entities	Public service mandated by governmental obligations
Business Scope	Business documents, information, small items	Personal letters and parcels
Service Objects	Specific customers in economic and trade sector	All members of society
Service Standards	Focus on meeting individual customer needs	Prioritize standardization and uniformity
Delivery Channels	Utilizes own networks or partnerships	Relies on post office networks
Pricing Mechanism	Determined by market demand and service efficiency	Standardized, low-price tariffs set by national postal unions
Enterprise Operations	Operates in a competitive market environment	Operates as public utilities with government support
Industry Regulation	Subject to market regulations and competition policies	Managed by postal departments
National Policies	Operates under fair competition principles	Enjoys various government subsidies and preferential policies

### **Strengthening Government Supervision of Express Delivery Services**

Strengthening government regulation is an important way to guarantee healthy development of the express delivery industry. The fast-growing express delivery industry is beyond the current regulation framework, and brings about lots of problems waiting to be solved (Fan et al., 2017). To strengthen government governance, we should take a series of measures to promote the healthy and stable development of delivery system. The following are some ideas. One thing is that, the government should carry out more stringent licensing policy toward the express delivery enterprises. With more and more delivery enterprises entering the market, the express delivery industry should ensure the enterprises entering the market are qualified and capable enough. Otherwise, a large number of poor-quality services will affect the consumers

and the market order. The licensing policy should contain an exam for the background of the delivery enterprises, check the financial strength, and require the enterprise to promise following the laws and regulations.

The next is to ensure the implementation of relevant labor laws and security laws. As we all know, the express delivery industry is highly capitalized on labor force, such as the delivery drivers and the warehouse staffs. To protect the interests of laborers is not only the duty of the government but also the social responsibility of the enterprises (Lantos 2001). The government should inspect and examine the implementation of relevant laws of the labor by the enterprises, encourage the enterprises to train the laborers regularly, and establish the perfect safeguard system of labor. So that we can prevent the phenomenon of unpaid wages and prevent accidents caused by the insecure warehouse, and improve the workers' satisfaction.

Finally, strike hard at the illegal activities, including tax evasion and the traffic of counterfeit goods. The illegal cargo in the process of delivery not only jeopardizes the normal operation of delivery industry, but also brings huge losses to the state revenue. To this end, the express delivery enterprises that involve the illegal activities should be punished strictly, and the special inspection should be carried out. What's more, we should exchange information with the international regulation departments, tracking the trail of the counterfeit goods transported across different countries, and preventing the spread of the illegal goods.

Supervision can enhance the competition of the industry (Aubert & Pouyet 2004), on the one hand. With the guidance of government supervision, the industry realizes the coexistence of multiple competitors, avoids the appearance of monopoly or dominant position, and creates an equal competition pattern, which encourages the enterprises to innovate and improve the service level. On the other hand, it protects the consumers' rights and interests. The consumers will enjoy the high-quality service, accurate delivery time and safe packaging if the government strengthens the supervision of the express delivery industry.

### **Recent Chinese Regulatory Bill on the Express Delivery Business**

On December 8, 2023, China's Ministry of Transport (2023) adopted the "Measures for the Administration of the Express Delivery Market," effective March 1, 2024. This regulatory bill aims to strengthen the supervision and management of the express delivery market, ensuring service quality and safety, and protecting stakeholder rights. Aligned with existing laws, the bill specifies the scope of application, corporate responsibilities, and regulatory mechanisms. The postal management department of the State Council and local agencies oversee the market, encouraging fair competition and high-quality development.

According to the new bill, enterprises engaged in express delivery must comply with laws, regulations, and societal norms while providing fast, accurate, safe, and resource-efficient services. Provisions are included for situations where multiple entities, termed headquarters express enterprises, jointly utilize unified trademarks, trade names, and waybills, requiring written agreements to clarify rights, obligations, and the uniform management of service quality



and security. Users of express delivery services are also obligated to comply with laws, provide necessary information, and adhere to national restrictions on sent items.

The "Measures" set comprehensive regulations for the safety of express items, consumer protection, sustainable practices, and market order. Items must be handled with care, explicitly prohibiting actions like throwing or trampling on packages, to prevent loss or damage. Smart technology use, such as smart express boxes, requires explicit user consent to protect privacy and foster trust. The penalties for non-compliance, including warnings, public criticism, and fines from 10,000 to 30,000 yuan, serve as deterrents against negligent practices. Local postal management agencies are empowered to create tailored regulatory plans, promoting express service venues and intelligent facilities to bridge the urban-rural service gap.

In addition, the regulations emphasize green and low-carbon development, advocating for environmentally friendly materials and practices, aligning with national and global climate efforts. Consumer rights and data protection are also prioritized, prohibiting illegal use or resale of waybills and ensuring stringent data protection standards for outsourced personal information handling.

Express carriers must periodically and accurately file complete data concerning the safe performance of their operations with the postal management sector. This express delivery data, which details reporting time, handling, safety precautions taken and any accidents or exceptions happening throughout the delivery procedure, is mandatory for the smooth and effective running of the entire value chain. By offering this information, companies promote transparency throughout their procedures and enable government agencies to monitor compliance with technical standards and operational protocols more accurately. This monitoring procedure in turn helps detect any existing risks and weaknesses, and thus create a safer and more dependable delivery environment. It contributes to the integrity of the entire postal system through a system of accountability and positive change.

Overall, the "Measures for the Administration of the Express Delivery Market" provide a robust framework to enhance the quality, safety, and sustainability of China's express delivery industry. By addressing package handling, consumer consent, data protection, and environmental sustainability, these regulations aim to foster a reliable and trustworthy delivery ecosystem, crucial for the industry's continued growth and evolution.

### **Integrating Postal and Express Delivery Services**

Integrating postal and express delivery services is a strategic move that can significantly streamline operations, increase efficiency, and reduce costs for both the government and delivery companies (FasterCapital 2024). This integration is particularly necessary in today's fast-paced and highly competitive logistics environment, where the demand for quick, reliable delivery services continues to grow. By leveraging the strengths of both postal and express delivery systems, the overall efficiency and effectiveness of the delivery infrastructure can be greatly improved.

One practical approach for integration is to establish joint service centers that offer both postal and express services. These centers can serve as one-stop locations where customers can get a comprehensive range of services, from traditional mail processing to modern express delivery options. This will certainly reduce the burden on users of such services because it will entail a single visit to a joint service center rather than visiting several places. This, in addition, will result in optimal utilization of resources since personnel and facilities can be better shared and utilized in such joint service centers.

Furthermore, networks can be integrated, and infrastructure can be shared among different logistics service providers. Sorting facilities, parcel sorting automation, vehicle and aircraft fleets are among the resources that can be pooled to achieve better utilization and reduce duplication. For example, the postal industry typically has very extensive networks and associated infrastructure, but these resources are underutilized during certain hours of the day (e.g. overnight) and certain days of the year (e.g. holidays). Postal operators can share excess capacity with express delivery operators, who in turn can provide postal operators with additional voluminous express product revenue and a stronger commercial rationale for better use of their existing assets. Overall, there will be greater operational efficiency as facilities and fleets will be reduced in duplication. Integrated logistics networks will also provide more direct and rapid transit routes, resulting in better overall service.

Postal and express collaboration can also achieve economies of scale and provide better service. When service providers work together, they can combine their fleets and negotiate lower rates for transportation, fuel, packaging and other commodities and supplies. This bulk purchasing power achieves greater economies of scale and results in lower operating costs, which can be passed on to customers through reduced transportation and delivery fees. Similarly, postal and express operators have different strengths and specializations. By working together, they can offer more efficient and innovative services that can better match the diverse and growing needs of customers. Collaboration can provide faster mail and parcel delivery, including same-day and even same-hour delivery. Hybrid delivery vehicles that combine letter and parcel delivery can achieve greater operational density and lower costs. Furthermore, the use of parcel sorting automation and postal automation hubs can provide faster transit times and better reliability.

Through integration, the government can raise the overall competitiveness and efficiency of the delivery industry. An integrated delivery system can pull in additional business both from local and foreign markets by providing quicker and cheaper services. This in turn can stimulate the national economy through the growth of e-commerce and smoother transactions in trade and commerce. An integrated system can also effectively manage peaks and valleys in business volume, ensuring quality service during peak periods.

Lower operating costs are another major advantage of integrating postal and express delivery services. The savings that result from shared networks, joint service centers and economies of scale can release funds that can in turn be employed to enhance the quality and scope of services offered. For example, savings from lower operating costs can be invested in

new technology such as advanced tracking and scanning systems and automated sorting facilities that can improve productivity and enhance the overall customer experience.

### **Integration of AI into Delivery Operations**

Integrating artificial intelligence (AI) into express delivery and postal operation brings extensive benefits (Javaid et al., 2022). Using artificial intelligence to complete vehicle and cargo matching in logistics transportation, the company can build a new freight matching platform with the digital infrastructure based on their own goods supply. And they can get access to social transportation capacity with discounted rates, thus improving transportation efficiency and lowering costs (Feng & Ye 2021).

And then, image and video recognition are integrated with GIS, multimedia coding and database to establish visualized warehousing, ordering and vehicle control intelligent systems, which can detect the warehousing condition and provide real-time decision supports, commands and dispatches based on image and video recognition. Thus, the order tracking and management as well as secure cargo transportation can be streamlined and well realized.

Furthermore, the advent of intelligent logistics station management and warehouse operations marks a significant improvement. By employing intelligent scanning and smart sensor installations at loading and unloading sites, automated collaboration among stacks, vehicles, and compartments is achieved, enhancing transportation efficacy. Likewise, within smart warehouse environments, the coordinated functioning of handling robots, sorting robots, and racks significantly boosts processing speeds, picking precision, and storage capacity.

AI facilitates the development of smarter operation and management models for the next generation of the logistics industry (Chung 2021; Javaid et al., 2022). Utilizing AI in tandem with big data analytics allows for precise matching of logistics transfer center and warehouse locations, optimizing site selection and operational efficiency. Furthermore, stakeholders across the supply chain, including manufacturers, suppliers, and logistics providers, can leverage AI to devise tailored product marketing strategies and streamline warehousing, transportation, and distribution plans.

### **Reducing Government Postal Expenses**

The reduction of postal costs for governments is an important goal that can be accomplished through various means such as increasing efficiency, maximizing resource utilization, and utilizing cost-effective technologies. In today's world, with the widespread use of emails that can replace mails, postal businesses need to adjust to the changing market in order to stay financially viable. Through strategic actions that cut costs and raise efficiency, governments can substantially lower postal costs without compromising service quality.

Increasing efficiency remains one of the most significant strategies for curbing postal costs. This can be done by way of automation and digital initiatives that ensure smooth running of the postal business (DeGaspari 2004). For instance, automated mail and package sorting machines can process huge volumes of mails and parcels in a short time and with precision that

surpasses their manual counterparts. This eliminates the need for numerous manual workers, thereby reducing labor costs and errors made by humans. The outcome is a boost in productivity and efficiency. Besides, digitalization of documents and workflows will eliminate much paperwork, raise accuracy of data, and speed up decision-making processes. The whole system becomes more cost-effective and efficient with this transition.

Maximizing resource utilization is another important aspect to consider. Postal businesses can examine the resources they currently have and deploy them where they will be of highest demand. This requires study of the demand and supply gap in various geographical locations and deploying workers and infrastructure accordingly. For example, postal offices located in rural and other low-demand areas with little or unused resources can be consolidated or transformed into community centers. Resources can be redirected to urban areas with high demands. Moreover, postal businesses can form partnerships with private express or courier companies that can share the resources and lighten the costs. Public and private sectors can each contribute their best to ensure proper functioning and improved services.

Lastly, the use of cost-effective technologies will bring postal businesses up to speed with modern technologies. Some of the technologies to consider include tracking systems, route optimization software, and automated customer service kiosks. Tracking technologies enable postal workers to monitor parcels in real time, thereby reducing cases of delays and losses, and increasing customer satisfaction. Route optimization software will assist workers in plotting the shortest and fastest routes possible, thereby lowering fuel consumption and transportation costs. Automated customer service kiosks and chatbots on websites can respond to regular customer questions and perform transactions such as postage payments. This will reduce long queues of customers during peak hours and allow staff to deal with complex issues and other non-automated tasks. All these measures will drive down operational costs for postal businesses. Automation and digital initiatives can lead to streamlined processes and minimize manual workforce (Madakam et al., 2019). Many postal businesses around the world have been embracing automation technologies to improve their sorting and delivery systems. The United States Postal Service (USPS), for instance, started investing in automation to improve the speed and accuracy of mail delivery back in the 1960s. As of 2022, USPS has installed more than 200 parcel sorting machines that can process 3,000 parcels per hour (USPS, 2022). This has greatly reduced the time taken to sort parcels and the number of workers needed to do so, thereby lowering costs. Many postal businesses were also adopting digital customer and delivery platforms as well as internal communications. These digital technologies cut costs while improving on service delivery and customer satisfaction.

Another good practice is the optimization of routes and delivery schedules. Postal businesses can utilize data collection and analysis as well as route optimization algorithms to determine the best delivery schedules and routes that will ensure reduction in fuel consumption and cost of transportation. The Royal Mail of the United Kingdom, for instance, introduced a dynamic routing and scheduling system that uses real-time data to predict the best routes based on volumes of mail to be delivered and traffic situations (Letsios et al., . This helped save huge

amounts of fuel and reduced greenhouse gas emissions by 50%. Besides, delivery timings can be shifted to times when there is less traffic to avoid delays from congestion. This will increase overall efficiency and cost-effectiveness.

Though it is a long-term investment, the use of renewable energy sources and energy-efficient infrastructure always pays off in the end (Wanapinit & Thomsen 2021). Postal businesses can install solar panels on the rooftops of their facilities and use the energy for both production and storage. This will lower costs of electricity and ensure a constant supply. Energy-efficient fluorescent lamps, cooling, and heating systems will also reduce utility costs. The Deutsche Post DHL Group, for instance, announced its intend and plan to use 100% renewable electricity across all its operations by 2050; a goal that has been achieved and is yielding great results (Deutsche Post DHL Group, 2022). Besides, there is the option of converting vehicle fleets to electric or hybrid models that will lower fuel consumption costs and greenhouse gas emissions, thereby contributing to environmental conservation. Reducing postal costs for governments will free up financial resources that can be channeled to more important sectors such as social welfare and infrastructure (Zhang et al., 2019). For example, savings from postal businesses can be injected into the health and education sectors as well as public transport systems to improve the lives of the populace. Besides, the savings can be used to finance innovative initiatives and technologies that will boost the quality of postal services, thereby creating a virtuous circle of progress and efficiency.

## **Conclusion**

China's delivery industry has witnessed tremendous growth over the past few decades. However, this rapid expansion has also brought about significant challenges, including the need for improved regulatory oversight, better integration of delivery networks, and more efficient cost management. Addressing these challenges is crucial for maintaining the industry's momentum and ensuring its sustainable development.

It is necessary that the government should strengthen the supervision of express delivery enterprises, and integrate the postal network with the express delivery network to reduce the government postal cost. The licensing standard should be raised, and the relevant labor and safety regulations should be enforced. The illegal operation should also be punished according to law. A regional supervisory network should be built, the public complaint hotline and the online tracking system should be established to guarantee fair competition, the citizen's rights and interests, and maintain the industry's good image.

There are plenty of advantages for integrating postal and express delivery, including operation simplification, efficiency improvement, cost reduction and service enhancement. The government should encourage postal and express delivery enterprises to set up joint service centers in less-developed regions and share and develop logistics information networks and resources. Additionally, promoting cooperation and mergers among postal and express delivery enterprises can increase industry concentration, ensuring sustainable development and contributing to economic growth. Businesses and citizens are the primary demand drivers for

express delivery, and the stable development of delivery enterprises will result in lower costs and better services for them.

Reducing government postal expenditure requires providing comprehensive solutions from an overall perspective. AI realizes multiple intelligent applications on the platform of the whole logistics industry chain, facilitating all-round delivery of everything to customers with ultra-speed and ultra-accuracy. Enhancing working efficiency, optimizing resource allocation, and practicing technologies for saving investment are the important ways to reduce government postal expenditure. Reducing costs by means of automation, digitalization, route planning, and new energy investment are effective approaches to guarantee high-quality service. Guaranteeing sustainable development of postal services, saving government expenditure, and realizing investment in more important fields are of great significance to promoting the overall economic and social development of the country.

## Works Cited

- Aubert, C., & Pouyet, J. (2004). Competition policy, regulation and the institutional design of industry supervision. *Recherches économiques de Louvain*, 70(2), 153-168. doi:10.1017/S0770451800011453.
- China's Ministry of Transport. (2023). Measures for the Administration of the Express Delivery Market. [https://xxgk.mot.gov.cn/2020/jigou/fgs/202401/t20240104\\_3980683.html](https://xxgk.mot.gov.cn/2020/jigou/fgs/202401/t20240104_3980683.html).
- Chung, S. H. (2021). Applications of smart technologies in logistics and transport: A review. *Transportation Research Part E: Logistics and Transportation Review*, 153, 102455. ISSN 1366-5545. <https://doi.org/10.1016/j.tre.2021.102455>.
- DeGaspari, J. (2004). High-Tech Delivery. *ASME. Mechanical Engineering*, 126(08), 38–42. <https://doi.org/10.1115/1.2004-AUG-4>.
- Deutsche Post DHL Group. (2022). Logistics of the Energy Revolution. <https://www.dhl.com/us-en/home/insights-and-innovation/thought-leadership/white-papers/logistics-of-the-energy-revolution.html>.
- Fan, W., Xu, M., Dong, X., & Wei, H. (2017). Considerable environmental impact of the rapid development of China's express delivery industry. *Resources, Conservation and Recycling*, 126, 174-176. <https://doi.org/10.1016/j.resconrec.2017.07.041>.
- FasterCapital. (2024). Postal service integration: The Power of Seamless Delivery: Postal Service Integration for Business Growth. <https://fastercapital.com/content/Postal-service-integration--The-Power-of-Seamless-Delivery--Postal-Service-Integration-for-Business-Growth.html>.
- Feng, B., & Ye, Q. (2021). Operations management of smart logistics: A literature review and future research. *Frontiers of Engineering Management*, 8, 344–355. <https://doi.org/10.1007/s42524-021-0156-2>.
- Gu, Q., Karoly, L. A., & Zissimopoulos, J. (2008). Small Business Assistance Programs in the United States: An Analysis of What They Are, How Well They Perform, and How We Can Learn More About Them. Social Science Research Network.
- International Postal Corporation. (2023). Global Postal Industry Preliminary Report.
- Javid, M., Haleem, A., Singh, R. P., & Suman, R. (2022). Artificial intelligence applications for industry 4.0: A literature-based study. *Journal of Industrial Integration and Management*, 07(01), 83-111.
- Lantos, G. P. (2001). The boundaries of strategic corporate social responsibility. *Journal of Consumer Marketing*, 18(7), 595-632. <https://doi.org/10.1108/07363760110410281>.
- Letsios, D., Bradley, J. T., Suraj, G., Misener, R., & Page, N. Approximate and Robust Bounded Job Start Scheduling for Royal Mail Delivery Offices?.
- Liu, J., Tang, J., & Sun, M. (2024). The impact of the COVID-19 prevention and economic interventions on express delivery industry: Evidence from China. *Journal of Management Science and Engineering*, 9(1), 16-37. <https://doi.org/10.1016/j.jmse.2023.07.001>.

- Madakam, S., Holmukhe, R. M., & Jaiswal, D. K. (2019). The future digital workforce: Robotic process automation (RPA). *JISTEM-Journal of Information Systems and Technology Management*, 16, e201916001.
- Molnar, M., & Wang, W. (2015). A Snapshot of China's Service Sector.
- Purcell, N. (2016). Postal service. *Oxford Research Encyclopedia of Classics*.
- Rabinovich, E., & Knemeyer, A. M. (2006). Logistics Service Providers in Internet Supply Chains. *California Management Review*.
- Rouse, W. B., Pennock, M. J., Yu, Z., & Pepe, K. (2018). A Conceptual Platform for Understanding and Managing Complex Service Enterprises: Case Studies in the Transformation of Healthcare Delivery. *Translational Systems Sciences*.
- Sage, D. (2017). Express Delivery. In A. M. Brewer, K. J. Button, & D. A. Hensher (Eds.), *Handbook of Logistics and Supply-Chain Management* (Vol. 2, pp. 455-466). Emerald Group Publishing Limited. <https://doi.org/10.1108/9780080435930-030>.
- Salawu, Y., & Ghadiri, S. (2022). Roles of trade logistics to the development of international trade: a perspective of Nigeria. *Journal of Transport and Supply Chain Management*, 16. <https://doi.org/10.4102/jtscm.v16i0.764>.
- Wanapinit, N., & Thomsen, J. (2021). Synergies between renewable energy and flexibility investments: a case of a medium-sized industry. *Energies*, 14(22), 7753. <https://doi.org/10.3390/en14227753>.
- Zhang, B., Zhang, L., Wu, J., & Wang, S. (2019). Factors affecting local governments' public-private partnership adoption in urban China. *Sustainability*, 11(23), 6831. <https://doi.org/10.3390/su11236831>.
- Zhu, X. H. (2014). Analysis of the human resource management based on private express enterprise. *Journal of Nanchang College of Education*. Retrieved from [http://en.cnki.com.cn/Article\\_en/CJFDTotall-LCYY201401041.htm](http://en.cnki.com.cn/Article_en/CJFDTotall-LCYY201401041.htm).



## **Navigating Balance: Individual Rights vs. Government Regulations by Tanchanit Keerasuntonpong**

In 1965, the *Griswold v. Connecticut* case challenged the Comstock Law which “prohibited any person from using any drug, medicinal, article or instrument for the purpose of preventing contraception” (“*Griswold*”). Other than criminalizing an individual's use of contraceptives, it was also illegal for others to assist or advise someone on this issue. The Court ruled that the state of Connecticut had no right to ban contraceptives for married couples as the judgment of marriage is “to be a sacred and private bond that lies within a zone of privacy” (Levy). The Supreme Court stated that the Comstock law violated the 4th and 5th amendment of the constitution which was established to protect one’s privacy. Justice William O. Douglas, the author of the majority opinion in this case, backs up the Supreme Court’s decision by arguing that: “Would we allow police to search the sacred precincts of marital bedrooms for telltale signs of the use of contraceptives” (“*Griswold*”)? Douglas’s statement highlights the potential conflicts and inconveniences that the Comstock law may bring upon its citizens. Furthermore, his questioning of whether married couples would allow police to invade their private space or not highlights the significance of privacy while suggesting that such laws would be an overreach of government power. To prevent citizens from being harassed by authorities even further and to protect their privacy, Douglas “formed” a new constitutional right of privacy based on the First Amendment, the Fourth Amendment, and the Ninth Amendment (Connecticut 21). He stated that: “These separate guarantees of privacy, taken together, give ‘life and substance’ to a broad, inherent constitutional right of privacy against government intrusion” (Connecticut 21). The ruling of *Griswold v. Connecticut* exhibited how state laws could potentially over-intrude into the private lives of married citizens and how, at times, citizens had to confront the challenges of simultaneously shaping the life they desired but also following the regulations that the government has pre-set. Nevertheless, this case also set a precedent for newer generations as it prevented states from banning contraceptives for married couples, ultimately allowing the coming generations to pave their path without the interference of the government.

In 2014, the pivotal ruling of the *Burwell v. Hobby Lobby* case allowed “privately held for-profit corporations to be exempt from a regulation that its owners religiously object to, if there is a less restrictive means of furthering the law’s interest” (“*Burwell*”). The company argued that providing their employees with access to birth control violated their religious beliefs and, therefore, would like to be exempted from the Affordable Care Act mandate, which required employers to “include contraceptive coverage as part of the insurance that they provide to their female employees” (United 1028). Hobby Lobby asserted that the Religious Freedom Restoration Act should protect them from the ACA’s requirement, as the purpose of the RFRA was to protect one’s religion from the intervention of government regulations (“*Religious*”). As a result, the Supreme Court was in favor of Hobby Lobby’s argument and permitted them to opt out of the birth control mandate. This case displays how government regulations can conflict

with one's religious beliefs, ultimately underlining the ongoing struggle of seeking a balance between establishing public policies and respecting individual rights. Nevertheless, the case of Hobby Lobby also opened the door for other for-profit organizations to acquire exemptions from certain national or state laws, risking an overuse of individual power to overturn national laws.

The core issue connecting *Griswold v. Connecticut* and *Burwell v. Hobby Lobby* focuses on the tension between individual rights and government regulations. In *Griswold v. Connecticut*, married couples encountered the challenge of accessing contraceptives due to the establishment of the Comstock law. Similarly, owners of Hobby Lobby ran into a conflict between their religious beliefs and the requirement of the Affordable Care Act which was established by President Barack Obama. Nevertheless, both cases overturned the situation by utilizing pre-existing laws to protect/defend their rights. For instance, in *Griswold v. Connecticut*, the court ruled that the prohibition of contraceptives violated the 4th and 5th amendment which "protects an individual's home and private life from interference by the government" (Levy). The 4th and 5th Amendments could challenge the Comstock law as the law interfered with the personal rights of married couples, ultimately limiting the paths they can embark on as a married couple: specifically in the aspect of reproductive decisions. Likewise, the owners of Hobby Lobby argued that providing their employees with birth control contravened the Religious Freedom Restoration Act. The purpose of this act was to defend an individual's religious exercise from any substantial burden created by the government, ultimately ensuring that Congress provides additional protection to those who are affected by laws of general applicability (United 1027). Due to the establishment of this act, the Supreme Court ruled that Hobby Lobby would be exempted from the mandate of the Affordable Care Act. Both cases clearly illustrate how certain national and state regulations can be overarching, essentially infringing upon personal rights. In *Griswold v. Connecticut*, the right to privacy in marital relations was upheld, while in the Hobby Lobby case, the right to religious freedom was protected. Both cases highlight the significance of pre-existing laws, as they played a major role in supporting citizens to protect their rights against general applicability laws. Lastly, the ruling of these cases demonstrates the judiciary's role in balancing the power that they possess with individual rights, ensuring that government regulations don't infringe upon one's liberty: an essential aspect of the constitution.

## Works Cited

- Birth Control Information to Be Displayed on New York Buses Is Held up by Marcia Goldstein, the Publicity Director of 'Planned Parenthood'.* *NPR.org*, npr, 13 July 2021, [www.npr.org/2021/07/13/1015623064/a-look-back-on-birth-control](http://www.npr.org/2021/07/13/1015623064/a-look-back-on-birth-control). Accessed 3 June 2024.
- Burwell V. Hobby Lobby - Dissenting Opinion.* *Wikimedia Commons*, Creative Commons, 8 Jan. 2024, [commons.wikimedia.org/wiki/File:Burwell\\_v.\\_Hobby\\_Lobby\\_-\\_dissenting\\_opinion.pdf](https://commons.wikimedia.org/wiki/File:Burwell_v._Hobby_Lobby_-_dissenting_opinion.pdf). Accessed 3 June 2024.
- "Burwell V. Hobby Lobby Stores, Inc." *Wikipedia the Free Encyclopedia*, Wikimedia Foundation, 7 Nov. 2023, [en.wikipedia.org/wiki/Burwell\\_v.\\_Hobby\\_Lobby\\_Stores,\\_Inc.](https://en.wikipedia.org/wiki/Burwell_v._Hobby_Lobby_Stores,_Inc.) Accessed 23 May 2024.
- A Clipping from the Front Page of the New Haven Register.* 8 June 1965. *The MiddleTown Press*, Hearst Media Services Connecticut, LLC, 26 May 2019, [www.middletownpress.com/news/article/Abortion-battle-stirs-up-state-s-Griswold-13896007.php](http://www.middletownpress.com/news/article/Abortion-battle-stirs-up-state-s-Griswold-13896007.php). Accessed 3 June 2024.
- Connecticut State, U.S. Supreme Court (U.S.). *Estelle Griswold v. Connecticut.* *United States Reports*, vol. 1, 7 June 1965, pp. 1-5. *State of Connecticut Judicial Branch*, Connecticut Judicial Branch, [www.jud.ct.gov/publications/Curriculum/Curriculum6.pdf](http://www.jud.ct.gov/publications/Curriculum/Curriculum6.pdf). Accessed 29 May 2024.
- Primary Source "Then"
- "Griswold. v . Connecticut." *Wikipedia the Free Encyclopedia*, Wikimedia Foundation, 18 Jan. 2024, [en.wikipedia.org/wiki/Griswold\\_v.\\_Connecticut](https://en.wikipedia.org/wiki/Griswold_v._Connecticut). Accessed 23 May 2024.
- Griswold V. Connecticut Became about Privacy; What If It Had Been about Equality.* 25 May 2015. *The New Yorker*, Advance Magazine Publishers, 25 May 2015, [www.newyorker.com/magazine/2015/05/25/to-have-and-to-hold](http://www.newyorker.com/magazine/2015/05/25/to-have-and-to-hold). Accessed 3 June 2024.
- Levy, Michael. "Griswold V. State of Connecticut." *Britannica Original Sources*, Encyclopedia Britannica, [www.britannica.com/event/Griswold-v-State-of-Connecticut](http://www.britannica.com/event/Griswold-v-State-of-Connecticut). Accessed 29 May 2024.
- Protestors Gather outside Tulsa Hobby Lobby.* *Juris Magazine*, Duquesne University School of Law's Juris Magazine, 8 Oct. 2014, [sites.law.duq.edu/juris/2014/10/08/burwell-v-hobby-lobby-a-crafty-conclusion/](http://sites.law.duq.edu/juris/2014/10/08/burwell-v-hobby-lobby-a-crafty-conclusion/). Accessed 3 June 2024.
- "Religious Freedom Restoration Act." *Wikipedia the Free Encyclopedia*, Wikimedia Foundation, 23 May 2024, [en.wikipedia.org/wiki/Religious\\_Freedom\\_Restoration\\_Act](https://en.wikipedia.org/wiki/Religious_Freedom_Restoration_Act). Accessed 3 June 2024.
- Supporters of Employer-paid Birth Control Rally in Front of the Supreme Court before the Decision in Burwell Vs. Hobby Lobby.* 30 June 2014. *Los Angeles Times*, Los Angeles Times Communications LLC, 30 June 2014,

[www.latimes.com/nation/la-me-ra-hobby-lobby-scotus-20140630-column.html](http://www.latimes.com/nation/la-me-ra-hobby-lobby-scotus-20140630-column.html). Accessed 3 June 2024.

United States, U.S. Supreme Court (U.S.). *Hobby Lobby v. Burwell*. *United States Reports*, vol. 47, 30 June 2014, pp. 5-18. *Yale Law School*, Yale Education, [law.yale.edu/sites/default/files/documents/pdf/Faculty/11-Siegel\\_and\\_Siegel.pdf](http://law.yale.edu/sites/default/files/documents/pdf/Faculty/11-Siegel_and_Siegel.pdf). Accessed 27 May 2024.

Primary Source "Now"

# **The Doomscrolling Epidemic: Influence of Short-form Social Media Content Political Polarization By Stan Cho**

## **Abstract**

The onset of social media has inspired a novel form of news media, one that influences its audiences both in unforeseen ways and at unprecedented rates. One such subset of social media is short-form content, which recently popularized and quickly integrated into all major platforms. By manipulating an algorithm that strategically encourages user engagement, taking advantage of both visual and auditory means, and presenting information in concise one-minute-long footage, short-form content has presented itself as a prominent method of information dispersion. In light of persistent political polarization and increasingly aggressive discourse, this experiment studies the role that short-form social media content plays in this conundrum. After considering several social media accounts with a combination of varying gender orientations, political partisanship, and religious creeds, this experiment confirms a correlation between the user's identity and the user's social media feed. Data obtained throughout this experiment demonstrated that, based on specific identity traits, posts trended towards two extremes — posts would confirm pre-existing beliefs of their targeted audience or would actively encourage discourse by provoking the user.

## **1 Introduction**

The Internet's profound influence on global connectivity stands as one of its most transformative impacts since its inception. The Internet has since birthed accessible social communities between people regardless of their location and language. Over time, these platforms have evolved into wholly new forms of communication that vary widely in their purpose and implications.

Traditional media outlets, such as printed newspapers and radio, have migrated into the online sphere, but they have not managed to overthrow the cultural influence that social media currently holds. The pursuit of user engagement remains the paramount objective of private enterprises; social media corporations are no exception in adhering to this principle.

Although social media companies do not exert direct control over the content that is created by their users, they have ensured total authority over the content that is ultimately presented to their users. The algorithm, a broad concept that encapsulates the complicated organization of content on social media platforms, has enabled uniquely personalized feeds.

The advent of short-form content has recently ushered in an unprecedented surge in social media users, lowering the threshold for content creation and exponentially enhancing access to entertainment. And despite the evident necessity for research, there exists a gaping hole in research related to the impacts of short-form content, especially considering the expansive grasp that it has made on its users.

In an era of vast media options, people often gravitate to sources that align with their preexisting views, inadvertently reinforcing their perspectives and intensifying polarization.

Before the age of the Internet, people would build loyalties to specific broadcast channels or certain op-ed columnists; these institutions would propagate consistent ideologies to their audience. Conversely, social media has enabled its audience to personalize their exposure to content; the divergence in both sources of information and the form in which information is delivered has fostered an environment where dialogue is harsh, and compromise is scarce. The inherently unsubstantial nature of short-form content encourages its audience to blindly accept content and construct undereducated opinions.

Social media platforms have exerted considerable influence over the dissemination of political events, the shaping of online discourse, and the formation of beliefs amongst their users. In light of these dynamics, this experiment delves into the distinctive characteristics of short-form social media as sources of political information.

## **2 Background**

### **2.1 Political Polarization**

Political polarization, the ideological divergence within political landscapes, is a phenomenon that has begun to plague America.<sup>27</sup> Though political scientists vary in their stance on polarization, it's clear that the adoption of extreme ideological views and unification against partisan foes are detrimental to democracy: 92% of Republicans are more conservative than the median Democrat, while 94% of Democrats are more liberal than the median Republican.<sup>28,29</sup>

### **2.2 To Choose A Side**

American journalist Ezra Klein explains that political media, in an attempt to commercialize its content in the age of the Internet, aims to garner political interest from newcomers to politics by promoting the concept of “choosing a side.”<sup>30</sup> Gradually, both Democrats and Republicans in the United States have shown largely inflated assumptions about their partisan opposition. Inaccuracies in these assumptions have become more pronounced in direct relation to the consumption of political media.<sup>31</sup>

Polarized media doesn't seek common ground; instead, it weaponizes differences.<sup>32</sup> Identity politics constitutes a socio-political framework premised on the idea that personal characteristics, including race, gender, sexual orientation, and ethnicity, significantly influence one's political beliefs. While identity politics acknowledges the historical and systemic injustices faced by marginalized groups, it is often misused to vilify opposing political factions, relying on anecdotal stereotypes rather than substantive evidence. Klein concurs, “The problem in our system is that it is built so that in conditions of polarization, there is not a way to resolve disagreement. This system gridlocks into forms of paralysis of just unending conflict.”<sup>33</sup>

---

<sup>27</sup> (Heltzel and Laurin)

<sup>28</sup> (Jilani and Smith)

<sup>29</sup> (Pew Research Center, “Political Polarization in the American Public”)

<sup>30</sup> (Klein, “Ezra Klein's Why We're Polarized Excerpt: The Media's Role”)

<sup>31</sup> (Ahler and Sood)

<sup>32</sup> (Klein, “Ezra Klein's Why We're Polarized Excerpt: The Media's Role”)

<sup>33</sup> (Klein, “Why We're Polarized: A Conversation with Jamelle Bouie on the Ezra Klein Show”)

Identity politics has emerged as a potent catalyst for polarization, fostering an “us versus them” mindset where people rationalize their political beliefs based on their judgment of certain identity traits. A notable example of this phenomenon is evident in statements made by international figures such as Donald Trump, who called for a “total and complete shutdown of Muslims entering the United States,” characterized illegal Mexican immigrants as “rapists,” and made derogatory remarks about an Indiana-born federal judge of Mexican descent, accusing him of bias.<sup>34</sup>

### **2.3 The Impact of Sources**

American educator Neil Postman asserts that different communication mediums manipulate our perception of reality and the ways that we process information. In other words, differences in the source of information can contribute to further political polarization and general misinformation. Postman opines that the written word, such as books and print media, encourages rational thinking alongside in-depth analysis for the readers to digest the information that they are presented. In contrast, Postman believes that entertainment-based media, primarily television, encourages a shallow and emotionally driven way of processing information.<sup>35</sup>

### **2.4 The Influence of Personal Identities**

In his quest to understand morality, American social psychologist Jonathan Haidt affirms that all members of society, regardless of their demographic, can recognize the difference between moral rules and social conventions.<sup>36</sup> Haidt notes that while moral rules hinge on preventing harm, social conventions are far more subjective and often depend on emotions of disgust and blatant disrespect.<sup>37</sup>

This definition of social conventions explains the differences in what is considered acceptable across different demographics.<sup>38</sup> The Pew Research Center demonstrated this notion in a comprehensive survey that analyzed the beliefs of five generations of people—Generation Z, born after 1996; Millennials, born 1981 to 1996; Generation X, born 1965 to 1980; Baby Boomers, born 1946 to 1964; and the Silent Generation, born 1928 to 1945. Numerous surveys demonstrate a trend that correlates increasing age with beliefs of free market capitalism, patriotic faith in the United States, disinclination towards same-sex and interracial marriages, preference for a patriarchal family structure, and discomfort regarding gender fluidity.<sup>39</sup>

Haidt notes that there exists a rider-elephant relationship when it comes to social conventions. He theorizes that there are two parts of the mind — the controlled mind, which is rooted in conscious thought, and the automatic mind, which is determined by instinct. Haidt notes that people let their automatic mind take over their controlled mind when morally

---

<sup>34</sup> (Chua)

<sup>35</sup> (Postman 45–46)

<sup>36</sup> (Haidt 42–43)

<sup>37</sup> (Haidt 63)

<sup>38</sup> (Haidt 79–80)

<sup>39</sup> (Parker et al.)

dumbfounded. In other words, people often let their gut feelings justify their reasoning, even when their reasoning is unfounded.<sup>40</sup> This is prominent in partisan bias in the United States, as voters are unlikely to change their opinions about certain candidates regardless of the momentous events that they may be responsible for.<sup>41</sup> “Voters will prefer to support a corrupt politician when the alternative is to support a politician who takes a fundamentally different policy stance.”<sup>42</sup> As such, politicians are easily absolved of their sins if they can secure support from a particular demographic of people.

## 2.5 Communication-based Social Media Platforms

Communication-based platforms like Twitter and Reddit, originally designed for interpersonal communication, have, over time, shifted their focus towards amplifying the expression of opinions.

Social media platforms are, at their core, profit-driven entities that hinge on user engagement. As such, these platforms are incentivized to manipulate content distribution to strategically drive online traffic.<sup>43</sup> This led to such platforms manufacturing incentives for users to visit, scroll through, and actively engage with their interfaces.

Of course, people have been conversing with others remotely for centuries. And yet these communication-based platforms allowed for both unprecedented speed and infinite variability in human interactions. Not only did people converse with others, but they could search for information, join communities with common interests, and spread their own opinions.<sup>44</sup> As such, as people become more reliant on social media platforms as a form of conversation, they become more inclined to rely on these platforms to educate themselves.

To make matters worse, social media platforms captivate their users by promoting content that fits their criteria for high engagement. Due to the provoking nature of political content, this type of media has often seen surges in popularity amongst users.<sup>45</sup> Furthermore, the geographic and identity anonymity that these platforms grant to their users encourages people to act comparatively more aggressively and radically than they would have in real-life encounters.<sup>46</sup>

The hostile environment fostered on these platforms encourages people to join others who share their opinions and defend their beliefs against those who disagree. This phenomenon confirms Klein’s notions that the modern political landscape encourages its members to choose a side.<sup>47</sup> People with the “same” opinions nurture stereotypes and aggressive stances against those who do not share their beliefs. Essentially, these social media platforms became indirectly responsible for gradual political polarization due to the toxic communication they embraced and promoted to their users worldwide.

---

<sup>40</sup> (Haidt 134–135)

<sup>41</sup> (Burns)

<sup>42</sup> (Jankowski et al.)

<sup>43</sup> (Kohrs)

<sup>44</sup> (Laub)

<sup>45</sup> (Kohrs)

<sup>46</sup> (Konnikova)

<sup>47</sup> (Klein, “Ezra Klein’s Why We’re Polarized Excerpt: The Media’s Role”)



## 2.6 Content-based Social Media Platforms

On the other hand, content-based platforms, such as Instagram and YouTube, were designed for those who want to share digital media. These social media platforms encouraged the onset of content creators, commonly referred to as influencers, who helm online communities. Faced with unlimited sources of information, users have begun prioritizing personal trust over generic popularity.<sup>48</sup> Users develop para-social relationships with their favorite influencers, which means that these users are ensured to engage with content on these social media platforms and encourage others to begin creating their own communities.

These influencer-derived communities become centralized networks in which even the tiniest bit of partisan bias expressed by the influencer can result in an amplified opinion spread throughout the community.<sup>49</sup> In fact, recent research demonstrates that younger generations (specifically teens and adults in Generation Z) show unprecedented loyalty to social media as a source of their daily news.<sup>50</sup> As per Postman's judgment, these individuals are driven to make uneducated opinions after being emotionally manipulated by their favorite content creators.

On that note, Postman questions the validity of the sources that visual media base their information on: "Why do you assume the accuracy of a printed referenced citation but not a speech-referenced one?... You are mistaken in believing that the form in which an idea is conveyed is irrelevant to its truth."<sup>51</sup> Contrary to the emphasis on citing credible sources in academic journals and research, political debates participated by social media users are often scarce with evidence.

Though the impact is often not as extreme, influencers have developed a level of persuasion attained by leaders of cults. For example, Ben Shapiro has embraced the online connectivity of his platform to spread his opinions to a wider population. He benefits from both his radical community that shares his beliefs and those who obsessively engage with his content out of vehement disagreement.

When introduced to the proponent of an idea, people are likely to submit to basic instincts of contextual or implicit bias. In an age of influencers and celebrities, they form loyalties with these individuals by watching their content, supporting their opinions, and aligning with their objections. This becomes especially dangerous when these influencers turn political.<sup>52</sup> Instead of aligning with their own beliefs created from their own consideration and intuition, people fall victim to blindly following the opinions of others. As such, users unknowingly begin shaping their opinions based on their reaction to the reasoning of influencers, regardless of this individual's professional credibility or prior education.

## 2.7 Social Media's Nonexistent Credibility

---

<sup>48</sup> (Dahan)

<sup>49</sup> (Centola)

<sup>50</sup> (Watson)

<sup>51</sup> (Postman 63)

<sup>52</sup> (Lai)

From a broad perspective, social media has significantly altered the political landscape, as all Internet users are able to produce and disseminate information, regardless of their credibility. Though not all incorrect information spread on social media is founded on malicious intent, content creators are convinced that they demonstrate knowledge due to their abundant exposure to information online. Researchers demonstrated that Americans who relied on television and social media for their political content were twice as likely to have low political knowledge as those who refer to newsprint and radio.<sup>53</sup>

Furthermore, social media users become accustomed to the simple, convenient nature of these platforms, meaning that they are highly unlikely to verify the veracity of their sources and consider various perspectives. Since content is advertised based on user engagement and not the value of information, content creators are encouraged to focus on how they present themselves online rather than prioritizing reliability; these practices create a cycle of rapidly spreading misinformation.

Instead of being given a comprehensive breakdown from reliable political scientists, an increasing number of people in the younger generation (ages 18-24) are choosing to obtain their political information from discussions between strangers in the comments of a YouTube video, satirical Reddit posts that reference obscure political controversies, or the radical ideologies propagated in a 280-character-long Tweet.<sup>54</sup> This practice is further exacerbated with short-form content, which is designed to be digestible, fleeting content that lurks in our minds in an ambiguous yet consequential way.

These individuals believe that their repeated exposure to a variety of political information allows them unparalleled truth, a phenomenon known as the illusory truth effect.<sup>55</sup> In reality, research reveals that Americans who turn to social media as their main source of political information are multiple times less likely to be invested and demonstrate awareness of various political topics, specifically presidential elections and pandemic news.<sup>56</sup>

Postman criticizes visual media and how it intentionally imitates information; he argues that “a news show, to put it plainly, is a format for entertainment, not for education, reflection or catharsis.”<sup>57</sup> Though Postman was reflecting on the composition of television media in the '80s, his depiction of visual political content perfectly encapsulates modern politics on social media. Content creators, much like television hosts, must ensure that their content “encompasses all forms of discourse” and that their content “must be a complete package in itself” in order to appeal to as many people as possible.<sup>58;59</sup> As such, visual content is bound to attract viewers but

---

<sup>53</sup> (Mitchell et al., “Americans Who Mainly Get Their News on Social Media Are Less Engaged, Less Knowledgeable”)

<sup>54</sup> (Booth et al.)

<sup>55</sup> (Wikipedia Contributors)

<sup>56</sup> (Mitchell et al., “2. U.S. Adults Who Mostly Get News through Social Media Lag behind Others in Attention to Election and Pandemic News”)

<sup>57</sup> (Postman 168)

<sup>58</sup> (Postman 178)

<sup>59</sup> (Postman 265)

fails to deliver valuable information. Newsprint and radio are not entertaining because, unlike visual media, they require genuine contemplation and historical examination.

## 2.8 The Algorithm

Institutions, such as printed newspapers and cable news, are held accountable for the accuracy of their sources and the nuance of their opinions.<sup>60</sup> Conversely, social media is built on the content of individuals. Social media platforms themselves hold comparatively less responsibility for the content on their platforms as long as they abide by their relatively lenient policies—Section 230 of the 1996 Communications Decency Act shields social media companies from being held accountable for the content spread on their platforms.<sup>61</sup>

The targeting of certain demographics is easier than ever through social media, as these platforms provide content creators with analytics to help them mold content to ensure that it reaches their target population. And despite the power to potentially disseminate content to millions of users, individual content creators are not responsible for the consequences of their content. When the burden of decades of brand loyalty is replaced by a hunger for fame, individual content creators are given more freedom in how they present their content. More often than not, influencers begin implementing tactics ranging from clickbait thumbnails to rage-inducing opinions to ensure user engagement.

In fact, social media platforms secretly enjoy this type of content. While you won't see any representatives helming these ideals, they embrace this content as it ensures user engagement. "Whereas editors once decided which stories should receive the broadest reach, today recommender systems determine what content users encounter on online platforms – and what information enjoys mass distribution."<sup>62</sup>

Recommender systems, commonly referred to as algorithms, offer an efficient and relatively accurate system of dictating what content is shared with which people. Algorithms will gather inventories of all content published on the platform and compile user activity (e.g., posts, likes, shares) relevant to each post.<sup>63</sup> A built-in integrity process validates that published content does not violate platform guidelines, primarily in the realms of copyright infringement and graphic content.<sup>64;65</sup> Algorithms then identify and rank users based on their likelihood to engage with the content, with repeated processes ensuring an improved algorithm with heightened accuracy.

## 2.9 Short-Form Content

Short-form content, a recent sensation, refers to video media on social media sites that are often limited to a maximum length of one minute. This content is differentiated from other types

---

<sup>60</sup> (Fengler)

<sup>61</sup> (Ortutay)

<sup>62</sup> (Meserole)

<sup>63</sup> (Meserole)

<sup>64</sup> (YouTube Help, "Copyright Strike Basics - YouTube Help")

<sup>65</sup> (YouTube Help, "Age-Restricted Content - YouTube Help")

of content, often designated its own section on various social media platforms (e.g., YouTube and Shorts, Instagram and Reels, Snapchat and Spotlight). Unlike its long-form counterparts, which demand more time and attention from consumers and require more effort and experience from its creators, short-form content is characterized by its brevity. As such, short-form content is both highly accessible and incredibly shareable, making it an effective tool for disseminating ideas, entertainment, and information across diverse audiences.

But the most notable quality of short-form content is that it weaponizes both visual and auditory components to grab the attention of its users. Unlike pictures, where users are forced to read, short-form content can utilize its video format to read out their information.<sup>66</sup>

In an attempt to capture readers' attention and curiosity in an age where social media platforms are heralded as the preferred source of information consumption, content creators have begun to utilize 'clickbait' – overpromising yet underwhelming content. Creators are able to view the relevant analytics that reflect the public reception of their content, meaning that they are able to hone their content to prioritize its recommendation to their target demographics.<sup>67</sup>

Unlike other content types, short-form content is often scroll-based, which presents users with an opportunity to build relationships with these platforms that are different from their previous exposure to social media. Instead of having the opportunity to choose which content they will view based on captivating thumbnails and eye-catching titles, users are immediately engaged with the short-form content. As such, short-form content creators often exploit compelling visuals, concise storytelling, and engaging hooks to create an immediate sense of intrigue that beckons viewers to stay tuned; users often binge-watch content from a specific creator, unknowingly developing strong parasocial relationships with these influencers. Furthermore, short-form content algorithms possess the remarkable capability to develop an exceptionally accurate comprehension of each user, owing to their ability to amass a vast and diverse dataset from their user base.<sup>68</sup> Beyond merely sifting through a wide array of content to pinpoint a user's niche preferences, these algorithms leverage the ingenious "infinite-scroll" design inherent in their platforms to entice users to endlessly contribute data to their ever-evolving algorithms.<sup>69</sup>

However, the fast-paced, quantity-over-quality approach to content that short-form media promotes is largely detrimental to the political education of its audiences. Research demonstrates individuals who rely on social media for their political news are almost four times less likely than those who turn to cable television and print newspapers to have actively followed the 2020 election.<sup>70</sup> Not only did the emphasis on engagement encourage creators to promote controversial

---

<sup>66</sup> (Reese)

<sup>67</sup> (Witte)

<sup>68</sup> (Potrel)

<sup>69</sup> (Woolley and Sharif)

<sup>70</sup> (Mitchell et al., "Americans Who Mainly Get Their News on Social Media Are Less Engaged, Less Knowledgeable")

opinions and conspiracy theories online, but the culture of online humor often downplays the grave importance of certain political events.<sup>71;72</sup>

### 3 Data and Methodology

This research sheds light on the intricate relationship between user preferences and the content that they encounter in the political sphere, providing valuable insights for understanding the dynamics of information dissemination on social media.

After creating a variety of new social media accounts on Instagram, we curated them based on numerous “stereotypical” identities — sex, religious creed, and political partisanship. Note that, apart from sex, this experiment used different accounts to engage — like, share, comment — with a myriad of content. If the content provided aligned with the account’s particular identity, the engagement would be increased.

The sex of the accounts was given the most concrete alignment. Not only were accounts assigned their particular sex during account creation, but they engaged with topics that tended to align with previous research conducted on gender-based interests.

Religious creed was the most straightforward identity to engage with; this was done to emulate how general populations show opposition towards other religions, as well as unconditional support for their own religious beliefs. As such, when proposed with religious content, the accounts would engage with these posts only if they matched the account’s assigned creed. The religions that were considered were Christian, Muslim, and atheist.

Political partisanship was split into two characteristics: right-leaning and left-leaning. Accounts were built by mimicking “natural” social media usage while manufacturing an identity that demonstrated clear yet nuanced partisanship. For instance, right-leaning accounts followed various conservative social media influencers, including, but not limited to, Ben Shapiro, Candace Owens, and the Tates.

But more importantly, this experiment focused on engagement when curating political partisanship (e.g., likes, comments, shares, views). With right-leaning accounts, this experiment prioritized content that promoted ideals such as free markets, Second Amendment rights, pro-life abortion, and traditional religious doctrines. On the other hand, with left-leaning accounts, this experiment prioritized exposure to ideologies such as LGBTQ+ support, social welfare programs, environmental protests, and pro-choice abortion.

This experiment aims to demonstrate how variances in user identities translate to the dissemination of content, which would then provide some insight into the extent to which short-form content affects its user’s identity and beliefs. In other words, this experiment aims to find the correlation between user identity and the type of content that populates their feeds.

### 4 Findings

---

<sup>71</sup> (Kulkarni)

<sup>72</sup> (Ohio State University)

The accounts created and curated for this experiment were labeled based on their specific gender identity, political partisanship, and religious creed. Male and female were abbreviated M and F, respectively. Right-leaning and left-leaning were abbreviated R and L, respectively. As for the creed, Christians were Ch, Muslims named Mu, and Atheists named At.

Data was collected by counting the number of political reels in a collection of thirty consecutive reels. There were a total of five trials to gather data for each account. This data was then sorted based on how many reels aligned with each of the three identity markers.

## **5 Discussion**

### **5.1 Error Analysis**

Despite the thoroughness of the execution of this experiment, it faced numerous potential sources of error. Most importantly, this experiment notes the inauthentic representation of the accounts that were generated for this research. Though these accounts were curated to fit their particular assigned identities, this experiment was not particularly interested in curating a natural usage of social media. Though social media has transformed into a main source of political information, its appeal comes from its variability in usage. As such, users of social media often use these platforms not solely for political information but to satisfy their desire for entertainment and communication. These accounts were not concerned with creating a realistic user history of either engaging with content that was unrelated to our research nor did it develop any relationships with other users. In fact, some of our accounts were banned by Instagram on suspicion of being fake accounts, demonstrating the uncanny nature of these accounts.

Furthermore, this experiment is simple in its characterization of identities. For instance, the political partisanship of these accounts was simply segregated into right-leaning or left-leaning, which fails to account for those who take a neutral stance, or those with varying degrees of radicality. Moreover, it must be noted that people tend to have a nuanced relationship with politics, and their ideologies may not perfectly fit within the boundaries of a single partisanship. On the other hand, this experiment fails to reflect on important identity characteristics, such as ethnic identity or age.

Likewise, this experiment struggles with its sample size. Even though around five to ten hours were spent on curating each account, this experiment concluded that its sample of twelve accounts was not enough to imply a concrete relationship between identity and content configuration.

### **5.2 Analysis of Accounts Based On Sex**

Certain corners of social media have degraded into cesspools of toxic masculinity. In these spheres, circulating content repackages gender stereotypes and misogyny as new revelations dubbed as "red pill" ideology. Especially considering the onset of certain influencers that have perpetuated the notion that "modernity is killing masculinity," such content has seen substantial popularity amongst certain users.<sup>73</sup>

---

<sup>73</sup> (Kimeu)

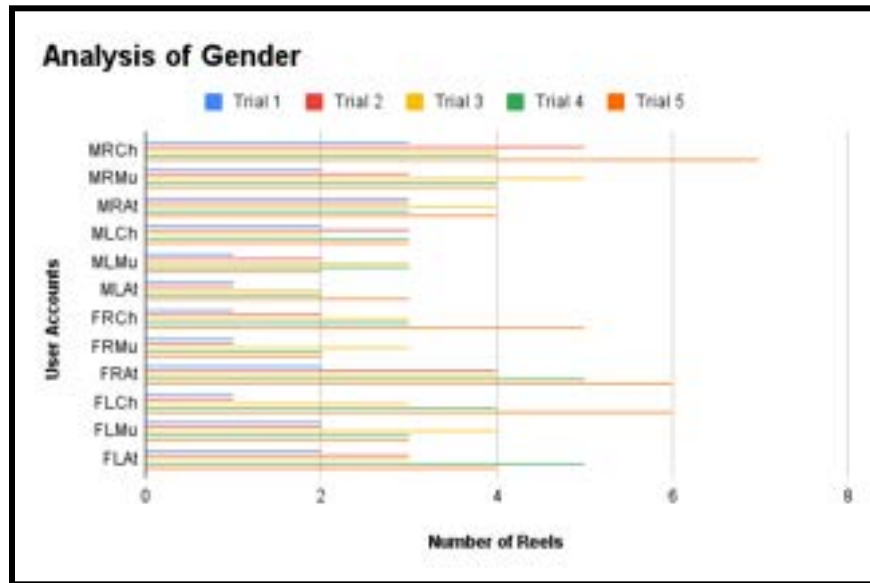

Fig 1. a. This chart depicts the number of reels that aligned with gender in each trial for each account.

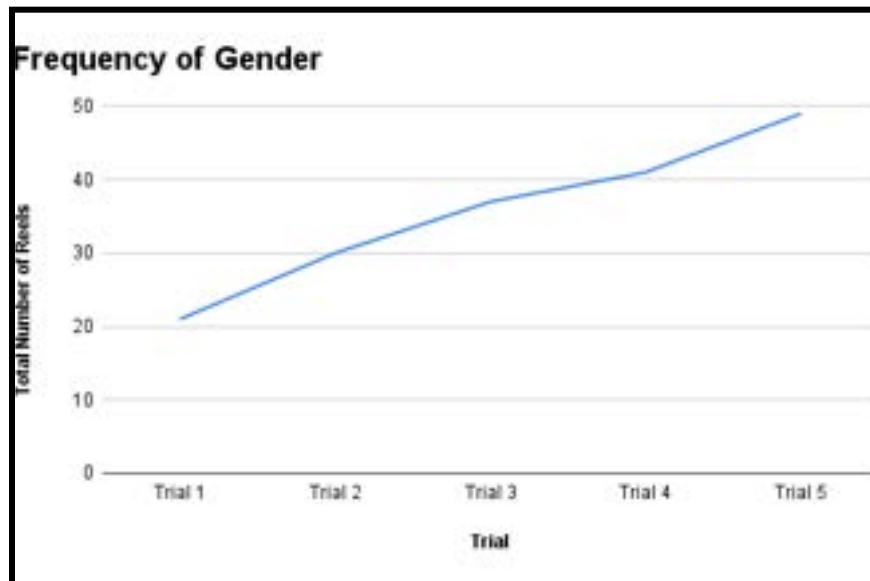

Fig 1. b. This chart depicts the change in the total number of reels that aligned with gender across the five trials.

On the other hand, gender studies have demonstrated both the vast representation of feminism and the merciless spread of gender stereotypes on social media. Not only do female influencers fuel unrealistic, dangerous beauty standards, but the hostile landscape of social media has given way to radical neoliberal feminism.<sup>74</sup>

<sup>74</sup> (Roberti)

The presence of gender-based content is well documented in this experiment's collected data. Not only did the content recommended demonstrate a correlation with the gender provided during account creation, but there was observed to be some semblance of a relationship for which accounts gained more gender-based content. For instance, right-leaning and male accounts would receive toxic masculine content, while left-leaning and male accounts would be exposed to a comparatively decreased number of such content. This discovery corroborates pre-existing data that hypermasculinity and misogyny tend to lean towards the right, especially amongst younger populations.

### 5.3 Analysis of Accounts Based On Political Partisanship

The experiment's findings aligned with those demonstrated in previous studies researching the impact of gender demographics on political partisanship. For instance, previous research has demonstrated that young women are inclined to lean liberal (with trends skyrocketing in the past few years), while young men demonstrate general indifference to politics and tend to prefer the status quo (thus, leaning right).<sup>75;76;77</sup>

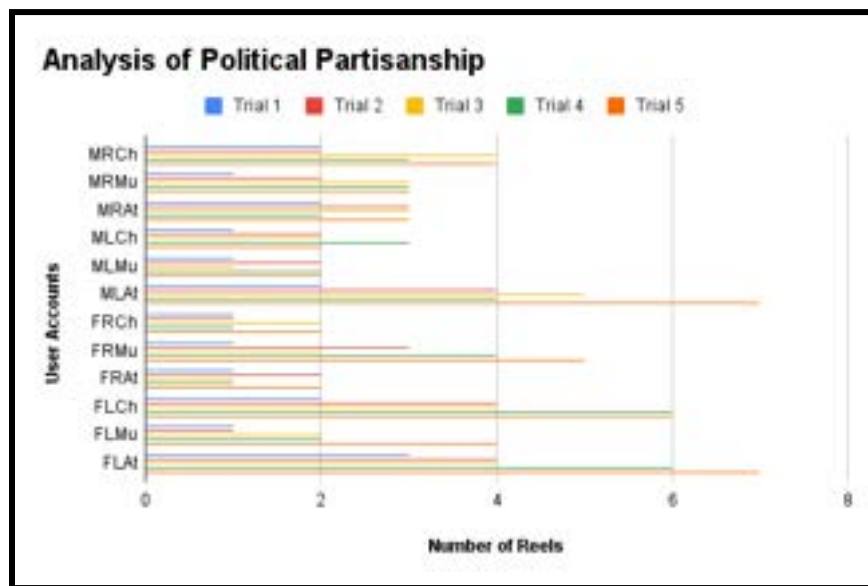

Fig 2. a. This chart depicts the number of reels that aligned with political partisanship in each trial for each account.

<sup>75</sup> (Visé, “Young Women Are Trending Liberal. Young Men Are Not”)

<sup>76</sup> (Cox)

<sup>77</sup> (Visé, “High School Boys Are Trending Conservative”)



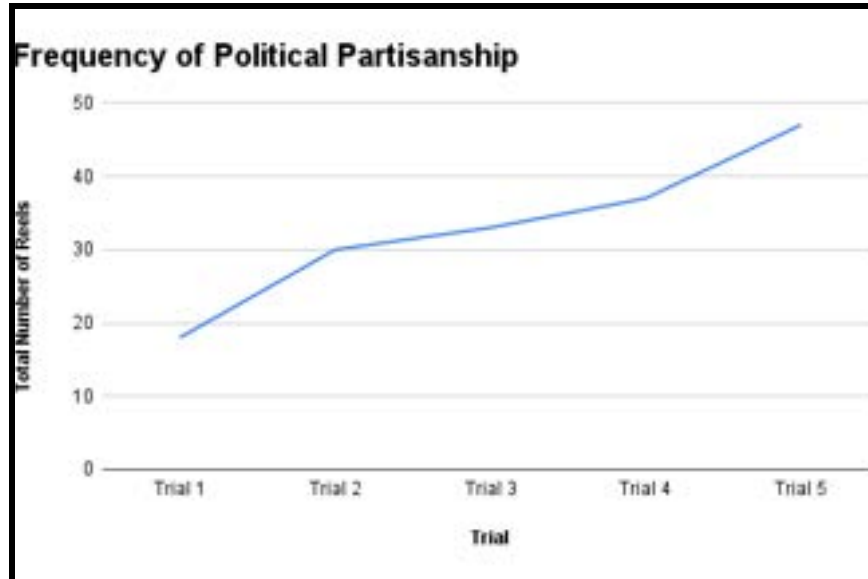

Fig 2. b. This chart depicts the change in the total number of reels that aligned with political partisanship across the five trials.

This data well represents the notion of political polarization fueled by social media usage. For instance, a 2018 Northwestern University study notes that exposing individuals to content that ideologically differs from their own simply encourages users to further reinforce their preexisting beliefs.

However, this polarization is difficult to explain when data regarding polarization appears to remain relatively unfazed. And yet, political discourse seems more violent and intolerant than ever. The Wall Street Journal suggests that while ideological polarization — “how far apart members of each party are on all issues” — has stayed stable over decades, affective polarization — “how much people of one party dislike members of the opposite party” — has skyrocketed in recent years, with much of this effect attributed to social media.<sup>78</sup>

#### 5.4 Analysis of Accounts Based on Religion

The Pew Research Center discovered that Christian Americans would use social media as a complementary means to practice their faith. Their study demonstrates that adults aged 18 to 29 were almost two times more likely to see religion shared online in contrast with adults aged 50 or more — 61% and 31%, respectively. This information, though restricted to Christian denominations, reveals that young social media users, who are more likely to view short-form content in this day and age, will likely be exposed to a variety of religious content online.<sup>79</sup>

<sup>78</sup> (Mims)

<sup>79</sup> (Pew Research Center, “Religion and Electronic Media”)

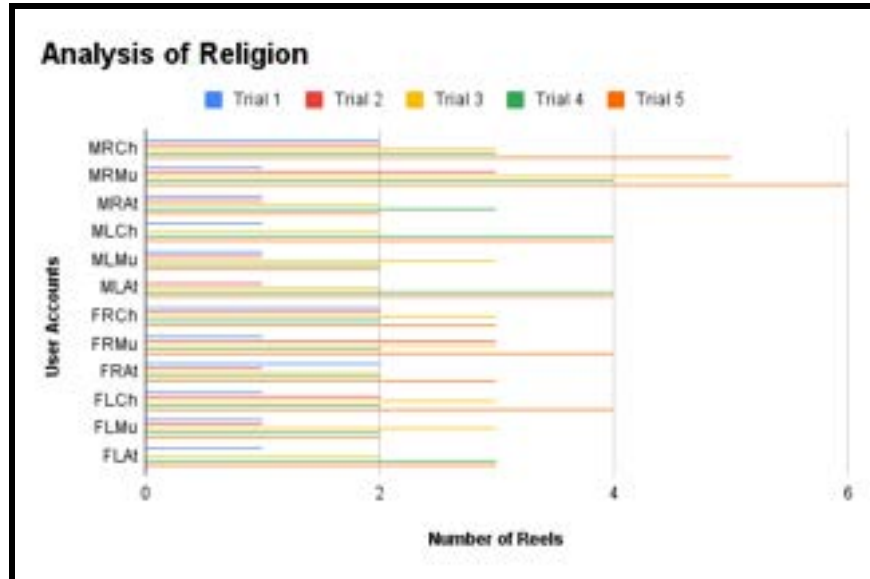

Fig 3. a. This chart depicts the number of reels that aligned with religion in each trial for each account.

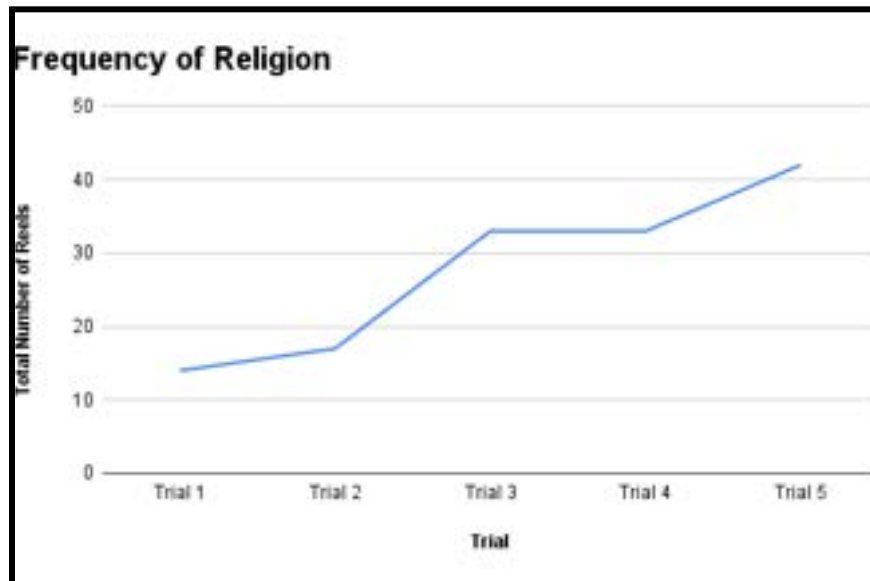

Fig 3. b. This chart depicts the change in the total number of reels that aligned with religion across the five trials.

This experiment corroborates these findings with a broader view of content based on other, previously unaccounted-for religious beliefs. For instance, Muslim accounts tended to receive content that skewed towards a defense of their religion, which aligns with ongoing trends of Islamophobia.<sup>80</sup> On the other hand, atheists were met with two opposite extremes: content that criticized religious creeds for their supposed irrationality and excessively religious content that

<sup>80</sup> (Venkatraman and Alsharif)

was populated with angry comments from other atheists. Moreover, this study accounts for accounts with an association to Christianity, noting that most of their content encouraged others to “read the Bible” or “follow the teachings of Christ,” with a semblance of a contemporary Jehovah’s Witness.

## **6 Conclusion and Discussion**

Because social media has become second nature to so many of us, it further emphasizes the need to understand the potential consequences of this seemingly harmless vessel for communication and content consumption.

More specifically, this study considered a collection of accounts that represented various gender orientations, political partisanship, and religious creeds; in the end, it demonstrates a gradual but clearly observable trend of social media short-form content aligning with user identity metrics. This study illustrates a relative confirmation of pre-existing studies surrounding media-incited polarization or the structure of social media platforms, as demonstrated by the collection of data based on the frequency of content that aligned with certain key identifiers for the account’s assigned identity traits.

There exist various opportunities for research in regards to considering a wider range of identities, ensuring consistency between accounts, and conducting the experiment on a larger scale. Analyzing trends in discourse amongst comments will reveal the climate of political debate online. Observing such trends amongst multiple platforms can provide a more nuanced look at potential patterns in short-form content distribution. Surveys will ensure that the quantitative data will come from nuanced feeds and that the qualitative data will provide first-hand insight into these social media users.

And, considering that short-form content is fairly new to the public, it is imperative that future research delve into short-form content. For instance, considering a wider demographic will help to verify the proposed correlation between short-form content and political partisanship.

Still, this initial step in considering the effects of short-form content provides insight into the necessity for further experiment and, in doing so, brings us one step closer to diminishing the destructive nature that short-form content may have on our political landscape if untamed.

## Works Cited

- Ahler, Douglas, and Gaurav Sood. "The Parties in Our Heads: Misperceptions about Party Composition and Their Consequences | the Journal of Politics: Vol 80, No 3." *The Journal of Politics*, 2018, [www.journals.uchicago.edu/doi/abs/10.1086/697253](http://www.journals.uchicago.edu/doi/abs/10.1086/697253). Accessed 23 Feb. 2024.
- Booth, Ruby, et al. "Young People Turn to Online Political Engagement during COVID-19." *Tufts.edu*, 20 Oct. 2020, [circle.tufts.edu/latest-research/young-people-turn-online-political-engagement-during-covid-19](http://circle.tufts.edu/latest-research/young-people-turn-online-political-engagement-during-covid-19). Accessed 23 Feb. 2024.
- Burns, Alexander. "Why America's Politics Are Stubbornly Fixed, despite Momentous Changes (Published 2021)." *The New York Times*, 8 Sept. 2021, [www.nytimes.com/2021/07/04/us/politics/biden-infrastructure-trump-republicans-democrats.html](http://www.nytimes.com/2021/07/04/us/politics/biden-infrastructure-trump-republicans-democrats.html). Accessed 23 Feb. 2024.
- Centola, Damon. "Why Social Media Makes Us More Polarized and How to Fix It." *Scientific American*, 15 Oct. 2020, [www.scientificamerican.com/article/why-social-media-makes-us-more-polarized-and-how-to-fix-it/](http://www.scientificamerican.com/article/why-social-media-makes-us-more-polarized-and-how-to-fix-it/). Accessed 23 Feb. 2024.
- Chua, Amy. "How America's Identity Politics Went from Inclusion to Division." *The Guardian*, The Guardian, 1 Mar. 2018, [www.theguardian.com/society/2018/mar/01/how-americas-identity-politics-went-from-inclusion-to-division](http://www.theguardian.com/society/2018/mar/01/how-americas-identity-politics-went-from-inclusion-to-division). Accessed 23 Feb. 2024.
- Cox, Daniel. "Liberal Girls vs. Conservative Boys? The Truth Is More Complicated." *MSNBC.com*, MSNBC, 11 Aug. 2023, [www.msnbc.com/opinion/msnbc-opinion/boys-arent-growing-conservative-just-not-politics-rcna98222](http://www.msnbc.com/opinion/msnbc-opinion/boys-arent-growing-conservative-just-not-politics-rcna98222). Accessed 23 Feb. 2024.
- Dahan, Eric. "Council Post: No One Is a Nobody: Social Media Redefines Fame for a Digital Generation." *Forbes*, 29 Dec. 2020, [www.forbes.com/sites/forbesagencycouncil/2021/12/30/no-one-is-a-nobody-social-media-redefines-fame-for-a-digital-generation/?sh=1dda46cf9591](http://www.forbes.com/sites/forbesagencycouncil/2021/12/30/no-one-is-a-nobody-social-media-redefines-fame-for-a-digital-generation/?sh=1dda46cf9591). Accessed 23 Feb. 2024.
- Fengler, Susanne. "Accountability in Journalism." *Oxford Research Encyclopedia of Communication*, 26 Mar. 2019, [oxfordre.com/communication/display/10.1093/acrefore/9780190228613.001.0001/acrefore-9780190228613-e-772](http://oxfordre.com/communication/display/10.1093/acrefore/9780190228613.001.0001/acrefore-9780190228613-e-772), <https://doi.org/10.1093/acrefore/9780190228613.013.772>. Accessed 23 Feb. 2024.
- Haidt, Jonathan. *The Righteous Mind: Why Good People Are Divided by Politics and Religion*. New York, Vintage Books, 2012, pp. 42–43, 63, 79–80, 134–135.
- Heltzel, Gordon, and Kristin Laurin. "Polarization in America: Two Possible Futures." *Current Opinion in Behavioral Sciences*, vol. 34, 1 Aug. 2020, pp. 179–184, [www.ncbi.nlm.nih.gov/pmc/articles/PMC7201237/](http://www.ncbi.nlm.nih.gov/pmc/articles/PMC7201237/), <https://doi.org/10.1016/j.cobeha.2020.03.008>. Accessed 23 Feb. 2024.

- Jankowski, Michael, et al. "Turning a Blind Eye on the Black Sheep: When Are Voters Loyal to Corrupt Politicians?" *Acta Politica*, 20 Oct. 2022, [link.springer.com/article/10.1057/s41269-022-00263-6](https://link.springer.com/article/10.1057/s41269-022-00263-6), <https://doi.org/10.1057/s41269-022-00263-6>. Accessed 23 Feb. 2024.
- Jilani, Zaid, and Jeremy Smith. "What Is the True Cost of Polarization in America?" *Greater Good*, 2019, [greatergood.berkeley.edu/article/item/what\\_is\\_the\\_true\\_cost\\_of\\_polarization\\_in\\_america](https://greatergood.berkeley.edu/article/item/what_is_the_true_cost_of_polarization_in_america). Accessed 23 Feb. 2024.
- Kimeu, Caroline. "As Social Media Grows in Kenya, so Does the Disturbing and Toxic 'Manosphere.'" *The Guardian*, The Guardian, 2 Oct. 2023, [www.theguardian.com/global-development/2023/oct/02/as-social-media-grows-kenya-so-does-disturbing-toxic-manosphere](https://www.theguardian.com/global-development/2023/oct/02/as-social-media-grows-kenya-so-does-disturbing-toxic-manosphere). Accessed 23 Feb. 2024.
- Klein, Ezra. "Ezra Klein's Why We're Polarized Excerpt: The Media's Role." *Vox*, Vox, 28 Jan. 2020, [www.vox.com/2020/1/28/21077888/why-were-polarized-media-book-ezra-news](https://www.vox.com/2020/1/28/21077888/why-were-polarized-media-book-ezra-news). Accessed 23 Feb. 2024.
- . "Why We're Polarized: A Conversation with Jamelle Bouie on the Ezra Klein Show." *Vox*, Vox, 31 Jan. 2020, [www.vox.com/podcasts/2020/1/31/21115058/why-were-polarized-jamelle-bouie-the-ezra-klein-show-sixth-and-i](https://www.vox.com/podcasts/2020/1/31/21115058/why-were-polarized-jamelle-bouie-the-ezra-klein-show-sixth-and-i). Accessed 23 Feb. 2024.
- Kohrs, Aaron. "How to Actually Fix Social Media to Reduce Political Polariz..." *AllSides*, 25 July 2023, [www.allsides.com/blog/how-actually-fix-social-media-reduce-political-polarization](https://www.allsides.com/blog/how-actually-fix-social-media-reduce-political-polarization). Accessed 23 Feb. 2024.
- Konnikova, Maria. "The Psychology of Online Comments." *The New Yorker*, The New Yorker, 23 Oct. 2013, [www.newyorker.com/tech/annals-of-technology/the-psychology-of-online-comments](https://www.newyorker.com/tech/annals-of-technology/the-psychology-of-online-comments). Accessed 23 Feb. 2024.
- Kulkarni, Anushka. "Internet Meme and Political Discourse: A Study on the Impact of Internet Meme as a Tool in Communicating..." *ResearchGate*, Elsevier BV, Dec. 2017, [www.researchgate.net/publication/329908632\\_Internet\\_Meme\\_and\\_Political\\_Discourse\\_A\\_Study\\_on\\_the\\_Impact\\_of\\_Internet\\_Meme\\_as\\_a\\_Tool\\_in\\_Communicating\\_Political\\_Satire](https://www.researchgate.net/publication/329908632_Internet_Meme_and_Political_Discourse_A_Study_on_the_Impact_of_Internet_Meme_as_a_Tool_in_Communicating_Political_Satire). Accessed 23 Feb. 2024.
- Lai, Stephanie. "Campaigns Pay Influencers to Carry Their Messages, Skirting Political Ad Rules (Published 2022)." *The New York Times*, 2 Nov. 2022, [www.nytimes.com/2022/11/02/us/elections/influencers-political-ads-tiktok-instagram.html](https://www.nytimes.com/2022/11/02/us/elections/influencers-political-ads-tiktok-instagram.html). Accessed 23 Feb. 2024.
- Laub, Zachary. "Hate Speech on Social Media: Global Comparisons." *Council on Foreign Relations*, 7 June 2019, [www.cfr.org/backgrounder/hate-speech-social-media-global-comparisons](https://www.cfr.org/backgrounder/hate-speech-social-media-global-comparisons). Accessed 23 Feb. 2024.

- Meserole, Chris. "How Do Recommender Systems Work on Digital Platforms?" *Brookings*, 21 Sept. 2022, [www.brookings.edu/articles/how-do-recommender-systems-work-on-digital-platforms-social-media-recommendation-algorithms/](http://www.brookings.edu/articles/how-do-recommender-systems-work-on-digital-platforms-social-media-recommendation-algorithms/). Accessed 23 Feb. 2024.
- Mims, Christopher. "Why Social Media Is so Good at Polarizing Us." *WSJ*, The Wall Street Journal, 19 Oct. 2020, [www.wsj.com/articles/why-social-media-is-so-good-at-polarizing-us-11603105204](http://www.wsj.com/articles/why-social-media-is-so-good-at-polarizing-us-11603105204). Accessed 23 Feb. 2024.
- Mitchell, Amy, et al. "2. U.S. Adults Who Mostly Get News through Social Media Lag behind Others in Attention to Election and Pandemic News." *Pew Research Center's Journalism Project*, 30 July 2020, [www.pewresearch.org/journalism/2020/07/30/2-u-s-adults-who-mostly-get-news-through-social-media-lag-behind-others-in-attention-to-election-and-pandemic-news/](http://www.pewresearch.org/journalism/2020/07/30/2-u-s-adults-who-mostly-get-news-through-social-media-lag-behind-others-in-attention-to-election-and-pandemic-news/). Accessed 23 Feb. 2024.
- . "Americans Who Mainly Get Their News on Social Media Are Less Engaged, Less Knowledgeable." *Pew Research Center's Journalism Project*, 30 July 2020, [www.pewresearch.org/journalism/2020/07/30/americans-who-mainly-get-their-news-on-social-media-are-less-engaged-less-knowledgeable/](http://www.pewresearch.org/journalism/2020/07/30/americans-who-mainly-get-their-news-on-social-media-are-less-engaged-less-knowledgeable/). Accessed 23 Feb. 2024.
- Ohio State University. "Not Just Funny: Satirical News Has Serious Political Effects." *ScienceDaily*, 23 Jan. 2017, [www.sciencedaily.com/releases/2017/01/170123115741.htm](http://www.sciencedaily.com/releases/2017/01/170123115741.htm). Accessed 23 Feb. 2024.
- Ortutay, Barbara. "What You Should Know about Section 230, the Rule That Shaped Today's Internet." *PBS NewsHour*, 21 Feb. 2023, [www.pbs.org/newshour/politics/what-you-should-know-about-section-230-the-rule-that-shaped-todays-internet](http://www.pbs.org/newshour/politics/what-you-should-know-about-section-230-the-rule-that-shaped-todays-internet). Accessed 23 Feb. 2024.
- Parker, Kim, et al. "Generation Z Looks a Lot like Millennials on Key Social and Political Issues." *Pew Research Center's Social & Demographic Trends Project*, 17 Jan. 2019, [www.pewresearch.org/social-trends/2019/01/17/generation-z-looks-a-lot-like-millennials-on-key-social-and-political-issues/](http://www.pewresearch.org/social-trends/2019/01/17/generation-z-looks-a-lot-like-millennials-on-key-social-and-political-issues/). Accessed 23 Feb. 2024.
- Pew Research Center. "Political Polarization in the American Public." *Pew Research Center - U.S. Politics & Policy*, 12 June 2014, [www.pewresearch.org/politics/2014/06/12/political-polarization-in-the-american-public/](http://www.pewresearch.org/politics/2014/06/12/political-polarization-in-the-american-public/). Accessed 23 Feb. 2024.
- . "Religion and Electronic Media." *Pew Research Center's Religion & Public Life Project*, 6 Nov. 2014, [www.pewresearch.org/religion/2014/11/06/religion-and-electronic-media/](http://www.pewresearch.org/religion/2014/11/06/religion-and-electronic-media/). Accessed 23 Feb. 2024.
- Postman, Neil. *Amusing Ourselves to Death: Public Discourse in the Age of Showbusiness*. London, Methuen, 1985, pp. 45–46, 63, 168, 178, 265.
- Potrel, Victor. "Council Post: Five Insights into the Popularity of Short-Form Video Content." *Forbes*, 6 Sept. 2022,

- [www.forbes.com/sites/forbescommunicationscouncil/2022/09/06/five-insights-into-the-popularity-of-short-form-video-content/?sh=17d07f0a79e5](https://www.forbes.com/sites/forbescommunicationscouncil/2022/09/06/five-insights-into-the-popularity-of-short-form-video-content/?sh=17d07f0a79e5). Accessed 23 Feb. 2024.
- Reese, Hope. "Delivering a Message by Voice, Even an Artificial One, Can Be More Compelling than Putting It in Writing." *Phys.org*, Phys.org, 20 Jan. 2023, [phys.org/news/2023-01-message-voice-artificial-compelling.html](https://phys.org/news/2023-01-message-voice-artificial-compelling.html). Accessed 23 Feb. 2024.
- Roberti, Geraldina. "Female Influencers: Analyzing the Social Media Representation of Female Subjectivity in Italy." *Frontiers in Sociology*, vol. 7, 21 Sept. 2022, [www.ncbi.nlm.nih.gov/pmc/articles/PMC9532601/](https://www.ncbi.nlm.nih.gov/pmc/articles/PMC9532601/), <https://doi.org/10.3389/fsoc.2022.1024043>. Accessed 23 Feb. 2024.
- Venkatraman, Sakshi, and Mirna Alsharif. "For Muslim Americans, a Spike in Hate Incidents Feels Reminiscent of Post 9/11 Islamophobia." *NBC News*, NBC News, 31 Oct. 2023, [www.nbcnews.com/news/asian-america/muslim-americans-spike-hate-incidents-feels-reminiscent-post-911-islam-rcna122570](https://www.nbcnews.com/news/asian-america/muslim-americans-spike-hate-incidents-feels-reminiscent-post-911-islam-rcna122570). Accessed 23 Feb. 2024.
- Visé, Daniel. "High School Boys Are Trending Conservative." *The Hill*, The Hill, 31 July 2023, [thehill.com/blogs/blog-briefing-room/4125661-high-school-boys-are-trending-conservative/](https://thehill.com/blogs/blog-briefing-room/4125661-high-school-boys-are-trending-conservative/). Accessed 23 Feb. 2024.
- . "Young Women Are Trending Liberal. Young Men Are Not." *The Hill*, The Hill, 6 Oct. 2022, [thehill.com/homenews/campaign/3675477-young-women-are-trending-liberal-young-men-are-not/](https://thehill.com/homenews/campaign/3675477-young-women-are-trending-liberal-young-men-are-not/). Accessed 23 Feb. 2024.
- Watson, Amy. "Gen Z News Consumption U.S. 2022 | Statista." *Statista*, Statista, 4 Jan. 2022, [www.statista.com/statistics/1124119/gen-z-news-consumption-us/](https://www.statista.com/statistics/1124119/gen-z-news-consumption-us/). Accessed 23 Feb. 2024.
- Wikipedia Contributors. "Illusory Truth Effect." *Wikipedia*, Wikimedia Foundation, 14 Feb. 2024, [en.wikipedia.org/wiki/Illusory\\_truth\\_effect](https://en.wikipedia.org/wiki/Illusory_truth_effect). Accessed 23 Feb. 2024.
- Witte, Melissa. "What This Stanford Scholar Learned about Clickbait Will Surprise You | Stanford News." *Stanford News*, Stanford University, 21 Mar. 2018, [news.stanford.edu/2018/03/21/this-stanford-scholar-learned-clickbait-will-surprise/](https://news.stanford.edu/2018/03/21/this-stanford-scholar-learned-clickbait-will-surprise/). Accessed 23 Feb. 2024.
- Woolley, Kaitlin, and Marissa Sharif. "The Psychology of Your Scrolling Addiction." *Harvard Business Review*, 31 Jan. 2022, [hbr.org/2022/01/the-psychology-of-your-scrolling-addiction](https://hbr.org/2022/01/the-psychology-of-your-scrolling-addiction). Accessed 23 Feb. 2024.
- YouTube Help. "Age-Restricted Content - YouTube Help." *Google.com*, 2019, [support.google.com/youtube/answer/2802167?hl=en&ref\\_topic=9387060&sjid=15067633758639329865-NA](https://support.google.com/youtube/answer/2802167?hl=en&ref_topic=9387060&sjid=15067633758639329865-NA). Accessed 23 Feb. 2024.
- . "Copyright Strike Basics - YouTube Help." *Google.com*, 2019, [support.google.com/youtube/answer/2814000?hl=en&p=c\\_strike\\_basic](https://support.google.com/youtube/answer/2814000?hl=en&p=c_strike_basic). Accessed 23 Feb. 2024.

# Unraveling The Mystery Of Medicine Effectiveness: A Comprehensive Analysis by Kurlus Kurlus

## Abstract

This study addresses the critical issue of medicine effectiveness, a fundamental aspect of modern healthcare. I aim to understand the factors that contribute to the efficacy of medicines, such as pharmacodynamics, pharmacokinetics, patient adherence, and personalized medicine. I hypothesize that integrating these elements will enhance our understanding and management of medical treatments, leading to improved patient outcomes. Using a comprehensive literature review and interviews with healthcare professionals, I examined drug mechanisms, absorption rates, patient compliance, and genetic factors. My findings indicate that the mechanism of action and therapeutic window are crucial for drug effectiveness, as seen with penicillin's inhibition of bacterial cell wall synthesis. Pharmacokinetics highlighted the importance of administration routes and metabolic pathways, exemplified by amoxicillin's excretion rates in varied renal conditions. Simplified dosing regimens significantly improved patient adherence, particularly in chronic conditions like HIV/AIDS. Personalized medicine, through genetic testing and biomarkers, demonstrated its potential in tailoring treatments, enhancing efficacy, and reducing adverse effects, evidenced by HER2-targeted therapies in breast cancer. This multifaceted approach is essential for optimizing medical treatments, underscoring the need for continued research and innovation in personalized medicine to transform patient care and improve health outcomes.

**Keywords:** biochemistry, medical biochemistry; medicine, medicine effectiveness

## Introduction

The quest for effective medicine is at the heart of modern healthcare. Medicine effectiveness is influenced by numerous factors such as pharmacodynamics, pharmacokinetics, patient adherence, and personalized medicine. Pharmacodynamics involves the drug's biological and physiological effects on the body, while pharmacokinetics examines how the body affects the drug through absorption, distribution, metabolism, and excretion (Rang et al., 2012). Understanding these processes is crucial for developing treatments that achieve desired therapeutic outcomes. Patient adherence and personalized medicine further complicate this landscape, as individual behaviors and genetic variations significantly impact treatment success (Osterberg & Blaschke, 2005).

Effective medicines not only need to interact correctly with biological targets but must also navigate the human body's complex systems to exert their effects. Penicillin, for instance, works by inhibiting bacterial cell wall synthesis, making it a powerful antibiotic for infections such as streptococcal pharyngitis (Katzung et al., 2012). However, the pharmacokinetics of a drug, including how it is absorbed, distributed, metabolized, and excreted, plays a significant role in its overall effectiveness (Rang et al., 2012).



Patient adherence is another critical factor. Non-compliance can result from complex dosing schedules, side effects, or misunderstanding the treatment's importance, leading to suboptimal health outcomes (Osterberg & Blaschke, 2005). Simplifying dosing regimens and providing adequate patient education can significantly enhance adherence, especially in chronic conditions like HIV/AIDS.

Personalized medicine, through genetic testing and biomarkers, has the potential to tailor treatments to individual patients, enhancing effectiveness and minimizing adverse effects (Collins & Varmus, 2015). For example, HER2 status in breast cancer patients guides the use of targeted therapies like trastuzumab, improving outcomes for those with HER2-positive tumors.

In conclusion, this study hypothesizes that a comprehensive understanding of pharmacodynamics, pharmacokinetics, patient adherence, and personalized medicine will enhance the effectiveness of medical treatments. My results support this hypothesis, highlighting the need for continued research and innovation in personalized medicine to optimize patient care and improve health outcomes.

## **Methodology**

This research employs a comprehensive literature review, analyzing peer-reviewed journals, clinical trial data, and authoritative textbooks. Additionally, I conducted interviews with healthcare professionals, including doctors, pharmacists, and researchers, to gain practical insights into the real-world application and challenges of medicine effectiveness.

## **Results and Discussion**

### **Pharmacodynamics**

- **Mechanism of Action:** At the core of a medicine's effectiveness is its mechanism of action, which describes how the drug interacts with cellular receptors or enzymes. For instance, antibiotics like penicillin inhibit cell wall synthesis in bacteria, leading to bacterial death and the treatment of infections such as streptococcal pharyngitis (strep throat) (Katzung et al., 2012) (Figure 1).
- **Receptor Binding:** The affinity and selectivity of a drug for its target receptor are crucial. For example, beta-blockers like metoprolol selectively block beta-1 adrenergic receptors in the heart, reducing heart rate and blood pressure in patients with hypertension and angina (Rang et al., 2012) (Table 1).
- **Therapeutic Window:** The range between the minimum effective dose and the toxic dose defines the therapeutic window. Insulin, used in diabetes management, has a narrow therapeutic window, requiring careful monitoring of blood glucose levels to avoid hypoglycemia (Katzung et al., 2012).

### **Pharmacokinetics**

- **Absorption:** The route of administration significantly affects absorption. Oral drugs like metformin, used in type 2 diabetes, must survive the acidic environment of the

stomach and the metabolic processes in the liver, known as first-pass metabolism. In contrast, intravenous drugs like morphine, used for severe pain, enter the bloodstream directly, offering rapid and complete absorption (Rang et al., 2012).

- **Distribution:** Once absorbed, drugs are distributed throughout the body via the bloodstream. Factors such as blood flow, tissue permeability, and protein binding affect distribution. Lipid-soluble drugs like diazepam can cross the blood-brain barrier, reaching central nervous system targets to treat anxiety and seizures (Rang et al., 2012).

- **Metabolism:** The liver plays a key role in metabolizing drugs, converting them into more water-soluble compounds for easier excretion. The enzyme cytochrome P450 metabolizes many drugs, including the anticoagulant warfarin. Genetic variations in these enzymes can influence drug metabolism rates among individuals (Collins & Varmus, 2015).

- **Excretion:** The kidneys are the primary organs for drug excretion. Renal function significantly affects drug clearance. For example, the antibiotic amoxicillin is primarily excreted by the kidneys, and impaired renal function can lead to drug accumulation and toxicity (Katzung et al., 2012) (Figure 2).

### Patient Adherence

- **Compliance:** Adherence to medication regimens is vital for achieving desired therapeutic outcomes. Non-compliance can result from complex dosing schedules, side effects, or a lack of understanding of the treatment's importance. For instance, patients with HIV/AIDS need to adhere strictly to antiretroviral therapy to prevent viral resistance and maintain immune function (Osterberg & Blaschke, 2005).

- **Behavioral Factors:** Psychological factors, such as motivation and belief in the efficacy of the treatment, as well as social support, can influence adherence. Simplified dosing regimens and patient education can significantly improve compliance. For example, once-daily dosing of antihypertensive medications can enhance adherence compared to multiple daily doses (Osterberg & Blaschke, 2005) (Table 2).

### Personalized Medicine

- **Genetic Factors:** Variations in genes can affect how individuals respond to medications. For example, genetic testing can identify patients who metabolize drugs like warfarin rapidly or slowly, allowing for dosage adjustments to optimize efficacy and minimize side effects (Collins & Varmus, 2015).

- **Biomarkers:** Biomarkers are measurable indicators of biological processes or responses to treatments. Using biomarkers can help tailor treatments to individual patients, enhancing effectiveness. For instance, HER2 status in breast cancer patients guides the use of targeted therapies like trastuzumab, improving outcomes for those with HER2-positive tumors (Collins & Varmus, 2015) (Figure 3).a a

### External Factors

- **Quality of Medicine:** The effectiveness of a drug can be compromised by poor manufacturing practices, improper storage conditions, or counterfeit products. Ensuring high-quality production and storage is essential for maintaining drug efficacy. For example, vaccines must be stored at specific temperatures to remain effective (DiMasi et al., 2003) (Table 3).
- **Healthcare System:** Access to healthcare, affordability of medications, and the quality of healthcare services play crucial roles in treatment outcomes. In regions with limited healthcare resources, even the most effective drugs may not achieve their potential impact. For instance, access to antimalarial drugs like artemisinin can be limited in some developing countries, affecting malaria treatment success (DiMasi et al., 2003) (Figure 4).

## **Conclusion**

The effectiveness of medicine is a complex interplay of pharmacodynamics, pharmacokinetics, patient adherence, personalized medicine, and external factors. My study found that integrating these diverse elements can significantly enhance understanding and management of medical treatments. The hypothesis that a comprehensive approach improves patient outcomes was supported by my findings. Continued research and innovation in personalized medicine are essential for optimizing treatment strategies and improving patient outcomes.

## **Acknowledgments**

I would like to acknowledge and thank my parents for supporting and helping me in this research, as well as especially thanking the Journal of Medicine as most topics discussed are not very easily accessible, and they had the most accessible accurate information.

## **Authors**

Kurlus Kurlus is a senior at North Penn High School in Lansdale, Pennsylvania. He is interested in chemical engineering with a specific interest in pharmaceutical engineering. He plans on pursuing a higher degree in medicine on the master's degree track.

## **Figures and Tables**

Figure 1: Mechanism of Action of Penicillin

## Mechanism of Action of Penicillin: Inhibition of Cell Wall Synthesis

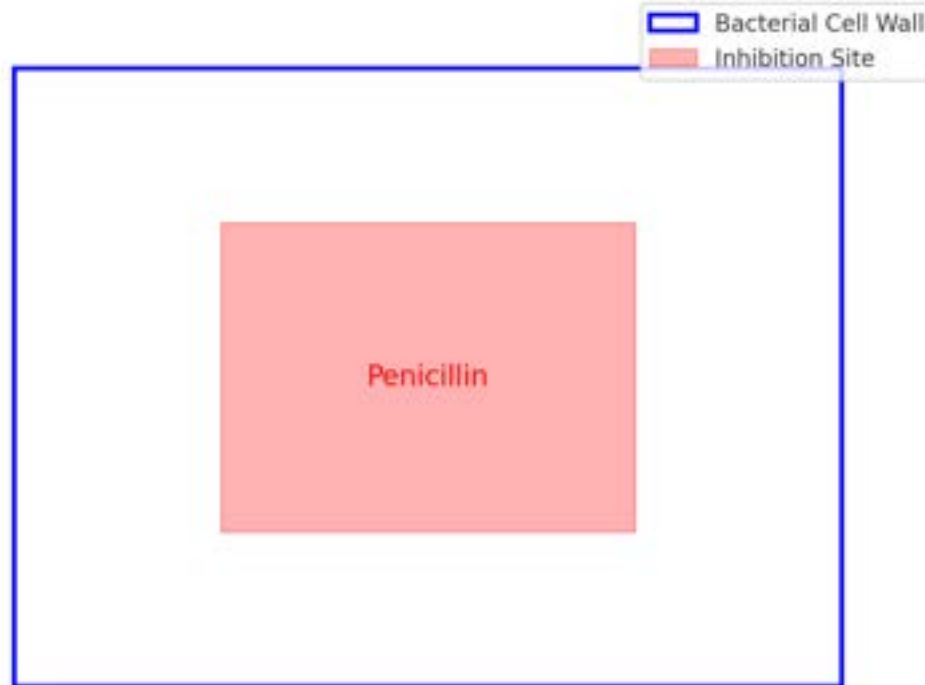

Source: Rang & Dale's Pharmacology, 2012

Description: Penicillin binds to penicillin-binding proteins in bacterial cell walls, inhibiting cell wall synthesis and leading to bacterial cell death.

Figure 2: Excretion of Amoxicillin

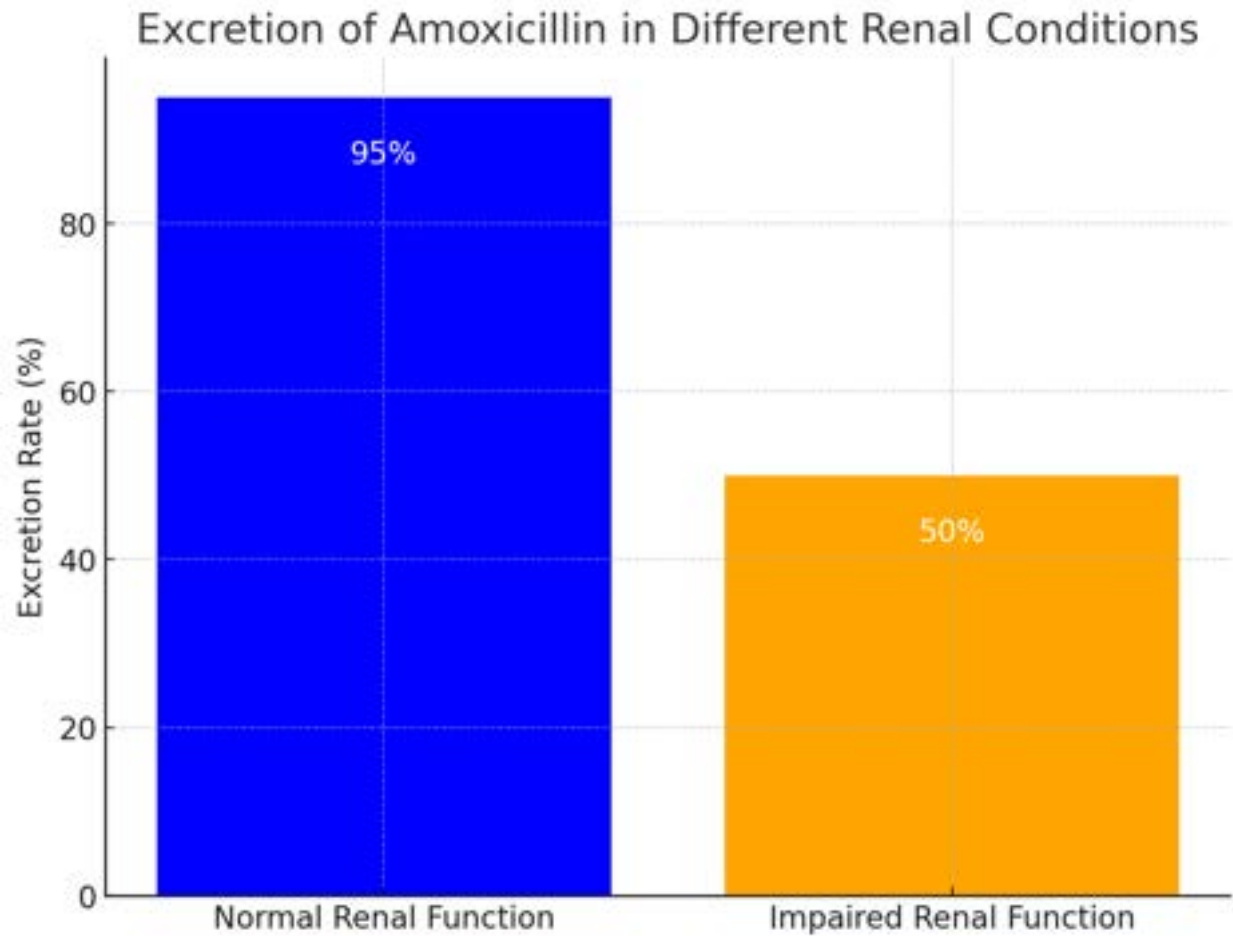

Source: Katzung, Basic and Clinical Pharmacology, 2012

Description: Excretion rates of amoxicillin in patients with normal and impaired renal function.

Figure 3: Use of HER2 Biomarkers in Breast Cancer

## Use of HER2 Biomarkers in Breast Cancer Treatment Outcomes

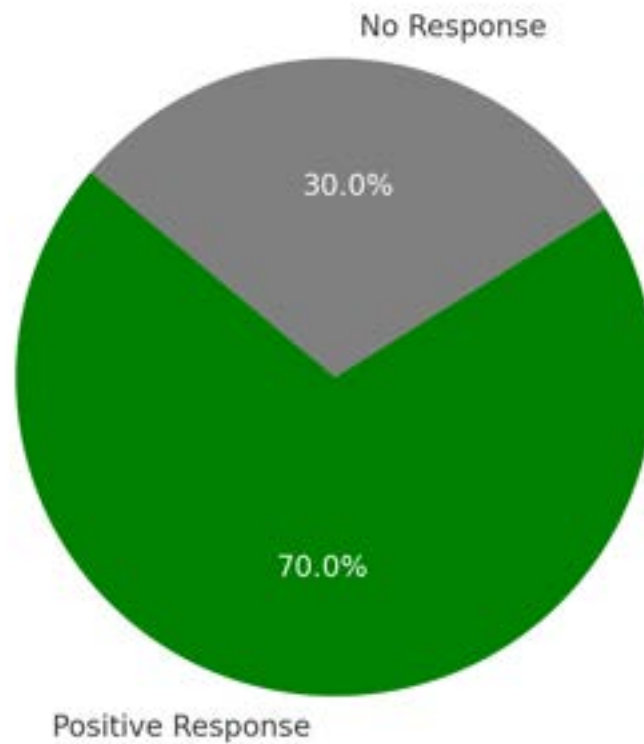

Source: New England Journal of Medicine, 2015

Description: The role of HER2 status in guiding breast cancer treatment with trastuzumab.

Figure 4: Access to Artemisinin in Malaria Treatment

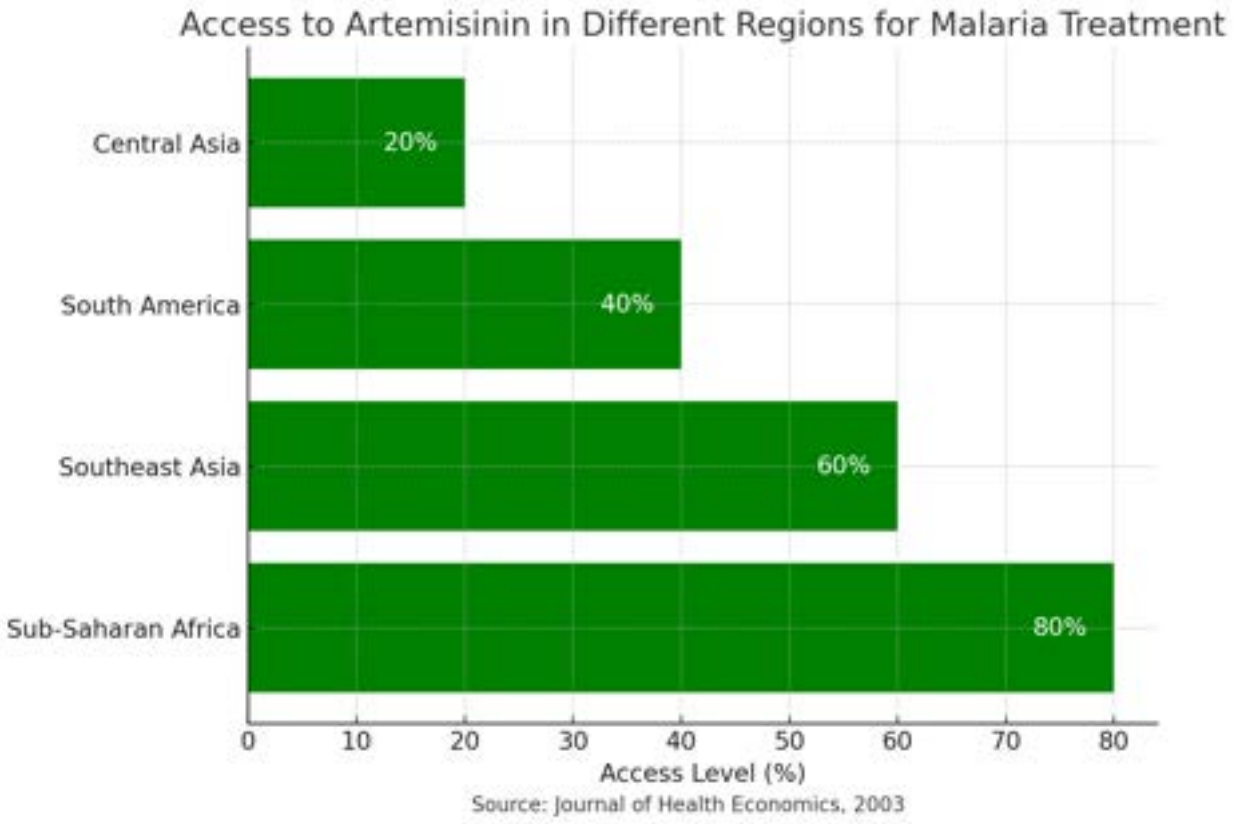

Description: Access levels to artemisinin in different regions for malaria treatment.

Table 1: Affinity and Selectivity of Beta-Blockers

Drug	Affinity (beta-1)	Selectivity (beta-1 over beta-2)
Metoprolol	8.2	74
Propranolol	7.8	4

Table 2: Adherence Rates with Different Dosing Regimens

Dosing Regimen	Adherence Rate (%)
Once-daily	85
Multiple-daily	70

Table 3: Storage Requirements for Vaccines

Vaccine	Storage Temperature (°C)
Varicella	-20
Hepatitis B	2-8
MMR	2-8
Influenza	2-8

### Reviewer Suggestions

- Jonathan M. Flower     Stephen F. Austin State University     1936 North St,  
Nacogdoches, TX 75965, United States     Jaime.flowers@safsu.edu
- Lars Osterberg     Stanford Medicine     291 Campus Drive, Stanford, CA 94305,  
United States     larso@stanford.edu
- Francis Collins     University of Michigan     500 S State St, Ann Arbor, MI 48109,  
United States     collinsf@mail.nih.gov



### **Works Cited**

- Collins, F. S., & Varmus, H. (2015). A new initiative on precision medicine. *New England Journal of Medicine*, 372(9), 793-795.
- DiMasi, J. A., Hansen, R. W., & Grabowski, H. G. (2003). The price of innovation: new estimates of drug development costs. *Journal of Health Economics*, 22(2), 151-185.
- Katzung, B. G., Masters, S. B., & Trevor, A. J. (2012). *Basic and Clinical Pharmacology*. McGraw-Hill Medical.
- Osterberg, L., & Blaschke, T. (2005). Adherence to medication. *New England Journal of Medicine*, 353(5), 487-497.
- Rang, H. P., Dale, M. M., Ritter, J. M., Flower, R. J., & Henderson, G. (2012). *Rang & Dale's Pharmacology*. Elsevier.

# **Relationship Between Social Intelligence and Bullying Behavior in Global Education City**

## **By Eunji Choi**

### **Abstract**

The paper aimed to discover the relationship between the unique befriending behavior of the students in Global Education City and their emotional sensitivity. Social intelligence, also known as emotional intelligence, refers to one's ability to sense and understand how and why other people feel certain ways. Low social/emotional intelligence could lead to issues relating to social interactions or interpersonal relationships. In Global Education City located in Jeju-island, South Korea, a unique befriending behavior has been detected. The students in this city rarely experience change in friend groups and hesitate to open themselves up to new incoming students. The result of this research identifies a correlation between such a trend and the social/emotional intelligence of these students, suggesting a possible cause of the phenomenon. Although future research should be conducted in order to identify stronger relationship between these two, this research could be considered a good start to resolve issues relating to friend group to as far as to teenage suicides.

### **Introduction**

As students grow, they experience change in many different ways. One big change that students go through is the friend group that they are part of. In most of the cases, moving from elementary school to middle school, then from middle school to high school, students attend different schools, forming a new friend group each time they are thrown into a new environment. However, this is not the case for students in Global Education City (GEC) located in Jeju island, South Korea. The students here rarely encounter change in friend groups, since the schools are combined into one, from kindergarten to high school. In other words, students go from kindergarten to high school with the same classmates, leading to less opportunity for them to experience change in friend groups or group dynamics.

This poses another challenge for the new students that transfer to schools in GEC in later years of school life, like in high school; because the friend group is already so tight by the time students graduate middle school and move to high school, it is hard—in fact, almost impossible—for the new students to become part of an already existing friend group. Statistics prove that about 1,500 students have graduated from GEC schools since 2014, showing that many students spend their teenage years in an environment where they face minimal change in friend group or dynamic (Oh, 2022). Furthermore, this contributes to bullying and outcast issues, as there is no change in interpersonal relationships throughout 12 years of school life. Thus, if a student fails to join a friend group within the first few months in the new school, they will highly likely be all by themselves for the rest of the school life. This could cause serious exclusion issues and even far as to bullying and suicide of teenagers.

### **Literature Review**

Bullying issues in GEC schools was a regularly reported issue. In one of the schools in the GEC, a freshman struggled from bullying from peers. The student was sexually harassed and beaten up, and despite reporting it to the school counselors, the issue was not resolved as the bullyer simply said it was not serious, but rather a joke (Park, 2013). The interview shows how students couldn't find another friend group to fit in, therefore had to suffer for almost two full years. Moreover, as the research proves, failure of adults to intervene and control the situation worsened victimization and bullying behaviors (Bouchard, 2018).

Such identified issues have been continuous for a decade as Jeju has a second highest teenage suicide rate in Korea (Kim, 2023). Considering that Jeju is merely a small island, the issue of teenagers being stressed and unable to cope with their emotions is an urgent problem that requires immediate solution.

Now, what could possibly be causing such an issue? One possible cause of the conflict here could be an increase in individualism. According to research, there is an apparent global trend of increasing individualism among people (Santos, 2017). The findings from the research applies to GEC schools as well; in other words, students are more likely to focus on themselves rather than the other students, which means whether or not the new students adapt well to the new environment is no concern of the returning students, showing lack of sympathy. Another study supports the same: the trend shows that there has been a rise of ego in American colleges over time, showing how teenagers these days are more egocentric and less selfless compared to the past (Twenge, 2008). Such a phenomenon has a strong relationship with social intelligence. Social intelligence is "capacity to understand others and to act rationally and emotionally in relations with others" (Herzig, 2019). This shows GEC students' behavior of not being able to relate to others' emotions show how they lack social intelligence. This is an important issue as it could lead to failure in social interactions.

Emotional intelligence, also known as social intelligence, has to do with four abilities: accurately perceive emotions in oneself and others, using emotions to facilitate thinking, understanding meanings, and managing emotions (Mayer, 1997). With low emotional intelligence, people can't accurately perceive others' emotions which would likely lead to conflicts in social settings. In contrast, people with higher emotional/social intelligence scored higher on emotion regulation ability while also viewing themselves as more interpersonally sensitive and prosocial. The same view from peer assessment was proven through the research (Lopes, 2005). This shows how high emotional intelligence leads to more prosocial behavior. In other words, people with low emotional intelligence will struggle to make friends, as well as to maintain interpersonal relationships. Furthermore, research supports how there is a positive correlation between emotional intelligence and social skills, as well as a negative correlation between those two variables and bullying behavior in students (Trigueros, 2020). This means that those with low emotional intelligence, or those who are unable to understand others and their emotions properly, will highly likely cause bullying issues.

After reading through the research, a question arose: is the phenomenon occurring in GEC also due to low social or emotional intelligence? To figure this out, this research developed a survey testing people's social/emotional intelligence.

## **Methodology**

The easiest route to answer such a question would have been conducting a survey asking if people think they have low social or emotional intelligence. However, choosing this method had two problems: One, people find it difficult to be honest about themselves in surveys, and two, people fail to make accurate self-judgements. "Social desirability bias (SDB) involves a person's responding to questions in a way that leads to a more positive depiction of the individual than is objectively warranted" (Beins, 2013). Due to this phenomenon, there is a high likelihood that the responses collected through surveys do not represent reality. The research also proves that collecting information only through surveys has very little likelihood of collecting reliable responses; multiple methods should be combined in order to enhance the accuracy and reliability, proving that survey results are not to be trusted (Devi, 2015). Furthermore, humans are incapable of making accurate self-evaluation due to lack of information, and possess biased or flawed self-assessments (Devi, 2008).

Therefore, instead of conducting a survey, this research decided to collect responses in a form of projective test that is similar to Myers-Briggs Type Indicator (MBTI). The first part of the test required respondents to choose a color that matches emotion of the given Graphics Interchange Format (GIF), and based on the choice the respondents made, scores were given; the scores represented whether the respondent correctly identified the corresponding emotion color to the GIF. This research believed this type of projective test would be more accurate and useful, as studies prove that "Projective tests might be more useful in cases where people lack understanding of their own personalities or in cases where people may be prone to self-deception" (Donnellan, 2021). Moreover, with MBTI test gaining worldwide popularity, this research thought showing the results in the form that is similar to that of MBTI would be effective, since research supports that "Familiarity with the information reduced attention to its content and also tended to increase reliance on category information in guilt judgments," which would make it more relatable and easily accessible to the respondents (Garcia-Marques, 2007). Therefore, the test was formatted similar to that of the MBTI test, and named Emotional Sensibility Test. As the target audience was students in GEC schools, the responses were strictly limited to high school students in GEC only.

In the Emotion Sensibility test that this research made, color was used to represent 4 different emotions: Love, Thankfulness, Frustration, and Compassion. For a long time, certain colors have been known to represent certain emotions. "Color can sway thinking, actions and cause reactions. Each color indirectly conveys a different message, sets a different mood and elicits a varied emotion" (Gupta, 2020). However, there is no universal agreement on which color represents which emotion, leading to studies like the following: "Some associations between colors and emotions were found, and the tendencies of associations were different

among emotions” (Takahashi, 2018). Also, the perception of the relationship between color and emotion depended on culture. It was concluded through the research that although Chinese and Thai students both identified red with anger, they did exhibit significant differences in other colors and emotions (Choosri, 2023). This shows how there is no single universal connection between certain colors and emotions; this posed a challenge to the research since not all the same colors will be perceived as the same emotions.

To combat this issue, it became necessary to discover the common ground that the majority would agree on. Through in-depth research, it was found that “Children had positive reactions to bright colors (e.g., pink, blue, red) and negative emotions for dark colors (e.g., brown, black, gray)” (Boyatzis, 1994). Another research also proved that yellow is related to joy-related emotions and pink represents romance-related emotions like love (Winkel, 2021). Moreover, a study showed how “it seems that people have been conditioned to see objects in white color as potentially “morally good” and those in black color as potentially “bad” (Chan, 2020). In many cases, such results were the conclusion of the studies that investigated the relationship between color and emotion. Based on these research, the color and emotion pair were determined as the following to be used in the Emotional Sensibility Test: pink with love, yellow with thankfulness, black with frustration, and white with compassion.

Another component to consider was the GIF files. There were three components that had to be avoided in choosing the clips: famous actor/movie, subtitles, and hand gestures.

Through research, it is proven that social media are capable of shaping public opinion: “the dynamics of information dissemination, interaction, and influence. With their global reach, real-time updates, and interactive features, social media platforms offer unparalleled opportunities for individuals to engage in public discourse, express their opinions, and shape collective attitudes and beliefs” (Anju, 2024). This meant that if the video clip portrays an actor or movie that is already well-known, it is highly likely that it would have been on social media, meaning that there is a possibility that the public already has a collective idea about the clip. In other words, if the clip is too famous, the responses might not accurately show what the respondents actually think or believe; instead it would indicate what the public opinion shaped through social media is like. Therefore, famous movie or actor clips were not used as part of the Emotional Sensibility Test test.

Subtitles were avoided for a similar reason. According to a study, it was proven that people would perceive and show greater magnitude of emotion when there were no subtitles along with a video (Silveira, 2014). In other words, subtitles could play a role in how and how deeply people perceive the contents of the video; it could easily become a third variable. Therefore, videos used for the Emotional Sensibility Test couldn’t include subtitles.

Videos with people showing a gesture posed the same problem. As research proves, “gesture is unmistakably similar around the world” (Cooperrider, 2020). Because there is a universal understanding for certain gestures like putting thumbs up—which is most commonly regarded as a sign of approval or agreement or compliment—there is a chance that people will perceive emotions based on these gestures, not facial expressions. Because the Emotional

Sensibility Test aimed to see how people sense and perceive emotion based on facial expression and its relationship to colors, the impact of gestures had to be avoided as it could easily become a third variable.

The second part of the Emotional Sensibility Test included questions that provided the respondents with certain situations and asked how they would act, given two sets of choices for response to the situation (Appendix A). Because the test had a specific goal to observe the decision making of the participants in these situations—ones that they could have been involved in real life—it was important to minimize the possibility of making these leading questions. In other words, the questions shouldn't hint at the respondents which would be regarded as 'showing better understanding of emotions.' As the research proves, "Leading questions result in biased or false answers" (Schade, 2017). To get more honest and accurate responses, only a simple description of the situation was described, and the respondents were given options for actions; this aimed to help the respondents visualize the situation and imagine what they would do, with the least intervention possible, through avoiding leading questions.

The results the respondents would receive were based on the scores that they got on each color and word question. In the Emotional Sensibility Test test, 24 different questions were asked to identify if respondents are capable of sensing emotions love, thankfulness, frustration, and compassion. Each 6 questions were related to one of the four emotions.

When first coming up with the score guidelines of the results, it was set so that the respondents had to score 5 or higher out of 6 in order to be qualified as possessing the capability to understand and sense that particular emotion. However, with the test run, it was proven that more than expected number of respondents find it challenging to score 5 or higher. This was due to the fact that it can't be denied that these questions include possibly biased perspectives since these questions were developed by a single researcher. In other words, what is set as the 'correct' answer, or the answer choice that means 'possessing the capability to understand and sense the emotion,' may not be applicable to all respondents. To resolve the issue, the change was made so that scores 4 or higher would be considered to be possessing the capability to understand and sense the emotion.

The 4 particular emotions—love, thankfulness, frustration, and compassion—had two outcomes depending on the score: 4 or higher scores would be considered good at sensing the emotion and 3 or lower scores would be considered bad at sensing the emotion. These combined would generate 16 different outcomes, depending on score from 4 emotions.

As mentioned previously, the reason why the results were shared in a form similar to that of MBTI was to maximize the number of respondents. The study proves MBTI's popularity: "more than two million people take the Myers-Briggs personality test each year" and has provided effective help in determining personality types (Rifkin, 2022). Following the global trend, the MBTI test has been extremely trending among teenagers, the main target audience of the research. The trend has gone so far to impact the job market. According to an article, "part-time job posting from a cafe in Seoul says, 'We hire people based on their MBTI results. People who have MBTI results that start with Es, please apply for this job.'" (Chea, 2022). This

shows the great extent to which the MBTI has been impacting the cultural aspect of Korean society.

Furthermore, along with the title and explanations for each outcome of the test, this research also provides animalistic characters for each outcome (Appendix B). This was not just to attract more respondents, but also to suggest that one's ability to understand and sense emotions cannot be measured solely through this test. By doing so, this research tried to prevent issues such as participants believing the outcome too much and thinking that he or she needs to seek assistance due to lack of ability to sense certain emotions. This is why the test informs the participant that this should only be used for fun and that the results may not reflect the professional studies and diagnosis from doctors. The usage of animal characters contributes to emphasizing that the test is designed for entertaining purposes, as well as to better illustrate what kind of person the participant is by providing an analogy.

The results were presented in a form of 4 alphabets each standing for capability of sensing each four emotions along with an animal character and description of the outcome.

For emotion Love, respondents who received a high enough score to be considered to be good at sensing love would get alphabet L for Love; respondents who didn't receive a high enough score to be considered to be good at sensing love would get alphabet H for Heavy Hearted.

For emotion Thankfulness, respondents who received a high enough score to be considered to be good at sensing thankfulness would get alphabet T for Thankfulness; respondents who didn't receive a high enough score to be considered to be good at sensing thankfulness would get alphabet A for Apathetic.

For emotion Frustration, respondents who received a high enough score to be considered to be good at sensing frustration would get alphabet F for Frustration; respondents who didn't receive a high enough score to be considered to be good at sensing frustration would get alphabet O for Oblivious.

For emotion Compassion, respondents who received a high enough score to be considered to be good at sensing compassion would get alphabet C for Compassion; respondents who didn't receive a high enough score to be considered to be good at sensing compassion would get alphabet S for Self-aware.

## **Discussion**

There were a total 37 collected responses (Appendix C). The collected responses showed that out of the 16 different results, Mindlessly Floating Jellyfish, HAOS (Heavy hearted, Apathetic, Oblivious, Self-aware), type was the most common outcome: 15 out of 37. This type would mean that the respondents often struggle with sensing love, thankfulness, frustration, and compassion. Overall, people in this type could be seen as lacking the ability to quickly and accurately understand or detect emotions. Showing struggles to connect with others' emotions, such a result suggests that GEC students are more individualized; they are too focused on

themselves that they can't consider or show thoughtfulness regarding how others might be feeling.

The second most frequent outcome was the Overthinking Hedgehog, HAFS (Heavy hearted, Apathetic, Frustration, Self-aware) type: 6 out of 37. This type would mean that while the respondents have no problem sensing frustration, they could often struggle with sensing love, thankfulness, and compassion. Frustration was the only negative emotion on this test. Usually, when people feel frustrated or have any negative emotions, their actions will show that, and it will most likely impact the way they treat others. When frustrated, it is hard to be gentle or nice; therefore it could be a good idea to try not to provoke someone who seems frustrated, as it will definitely affect how they treat us. In other words, being able to sense others' frustration—or any kind of negative emotion—can be beneficial as it will get us out of the risk. In contrast, positive emotions don't really have a negative impact on us, so it doesn't really matter whether or not one can sense if the other person is feeling emotions like love, compassion, or thankfulness. The fact that there were many people who could sense frustration (negative emotion), but not love, thankfulness, and compassion (positive emotion) further suggests the individualized mindset of the GEC students. If certain emotions that others feel don't impact them, they wouldn't care; but frustration can, therefore, they do care.

One of the least frequent outcomes was the Passionate Retriever, LTFC (Love, Thankfulness, Frustration, Compassion) type: 1 out of 37. This type would mean that the respondents have no problem sensing all four emotions. The fact that this type was one of the least frequent results suggests that students in GEC might really be struggling from low social/emotional intelligence.

In general, the result indicates that students in the GEC community lack the ability to sense a certain type of emotion, if not multiple emotions. More than half of the respondents seemed to struggle detecting 2 or more emotions, showing lack of understanding in other people's minds and feelings.

LTFC	1	HAFC	-	LAFC	1	HTFC	1
LTFS	-	HAOS	15	LAOC	-	HTFS	4
LTOC	-	HAOC	1	LAOS	2	HTOC	-
LTOS	-	HAFS	6	LAFS	4	HTOS	2

## Conclusion

The results of the study show that the majority of the respondents—mainly GEC students—have shown low capability to understand or sense emotions, particularly love, thankfulness, frustration, and compassion which were used in this study. This suggests that these students have low social/emotional intelligence; they might struggle to understand how and why others feel certain emotions, and this could lead to issues as these individuals socialize and



interact with other people. They might have a hard time connecting with others, leading to social isolation or many other challenges.

Based on the result, there exists a correlation between GEC students' emotion sensing ability and the unique befriending behavior of them. Although it can't be concluded that the particular behavior is caused by the students' low social/emotional intelligence, it is highly likely that low social/emotional intelligence could be a factor that contributes to the phenomenon.

This is a serious issue as it could lead to other problems such as isolation of people. The harder people find to connect with others, the less they will interact; and these children will grow up to become a member of this society. In other words, the world will become disconnected. With the great extent of individualization, it will become harder to ask for help or even talk to others; people will only care about themselves and not others.

The potential causes of this phenomenon could have been the high educational standards of Korean culture. In Korea, students are constantly pressured to do well in school so that they go to a good university, then get a good job. In fact, they are taught to do better than their friends and be competitive as grades are scored on the basis of relative scales. This societal pressure could have caused students to be neglectful of others, even their friends, and how they might be feeling or thinking.

### **Limitation**

As mentioned previously, there doesn't exist a universal agreement on which color represents which emotions. Therefore, the result of this research might not be applicable to everyone; the results could vary depending on the culture the respondent grew up in, as well as their nationality. The relationship between color and emotion used in this research was the common ground of multiple studies combined, so that it could be applicable to a wider range of audience.

Moreover, each individual has its unique ways of interpreting visual stimuli. Some people might focus on small details from facial expressions while others pay more attention to body language or gestures. In other words, the GIFs could be interpreted differently depending on the culture and personal traits.

In addition, considering that Global Education City includes 4 schools, all of them ranging from kindergarten to highschool, the sample size is small. This means that the results have the possibility that it doesn't accurately or fully represent the students in GEC.

Although the Emotional Sensibility Test test has its basis on the proven studies and scientific research backgrounds, it hasn't been qualified by professionals; in addition, there is a possibility that different cultural backgrounds and traits might impact the results, further proving the imperfection of the test. Therefore, although this could be used as an entertaining simple guideline to see people's capability of empathizing, it shouldn't be used to diagnose any type of mental disorders or mental health issues.

### **Appendices**

## Appendix A: Full questionnaire

You worked hard yet failed an exam. While crying, your friend finds you. He/she hugs you, saying, "It's okay, you'll do better next time," comforting you. At this moment, what are your thoughts?

1. "Yes, it will be okay. I'm grateful to have such a friend," feeling thankful.
2. "I appreciate it, but right now, I want to be alone," wanting some alone time.

You and your friend are having a serious conversation about your life moving forward. As you talk about the future, the topic shifts to marriage. What do you say at this moment?

1. "Having a stable life with someone is what I want," indicating a positive attitude towards marriage.
2. "While love is important, I want to live exploring what I'm good at and what I want," dreaming more of a career-oriented life than marriage.

On a day when you feel inexplicably gloomy, what might be the reason you're feeling down today?

1. Things aren't going as I hoped.
2. Relationship issues are causing stress

You transferred to a new school. On the first day, you got lost in the hallway and asked a passing friend for directions. That friend kindly escorted you to the classroom. The next day, when you encounter that friend at school, how do you act?

1. "Ah! My savior!"; you say hi and say thank you once again.
2. "I thanked her/him yesterday, so I don't have to say anything now"; you just pass by.

While passing by, you accidentally drop your wallet. Unaware, you continue walking, but a passerby picks it up and hands it to you. How do you react at this moment?

1. "Oh! I didn't realize. Thank you!" I express gratitude and continue on my way.
2. "Oh! Thank you. I'd like to repay you somehow..." Out of gratitude, I might buy them a coffee or something similar.

On the way out of the house, you realize you left your wallet behind and don't have your card with you. You've already ordered a drink at a store that only accepts card payments. The person next to you offers to pay for you. What do you do?

1. "Thank you." I consider myself lucky.
2. "Thank you. Can I have your bank account number?" It's a small amount, but I make sure to repay the kindness.

You discover a cat lying dead in the middle of the road. How would you handle it?

1. You're worried it might get run over and feel too sad about it. You move it to a place where cars don't pass.
2. It's unfortunate, but there's nothing you can do. You leave it there.

During lunchtime, your friend is frantically searching the entire school because they lost their necklace. What would you do?

1. "Where's the last place you saw it?" You help them search.

2. "Why don't we check where you last had it? Good luck with your search!" You encourage them to search diligently.

While riding the bus home, an elderly man falls as he's getting off at a stop. Luckily, he doesn't seem to be seriously injured but appears startled. There's still a considerable distance to your home. What would you do?

1. "Are you okay?" You get off the bus and make sure he's alright. You offer support.
2. "Is he okay?" He didn't get hurt too badly... You look through the bus window if he's alright as the bus departs.

Your friend is staring at a post on the bulletin board with a sigh. What would you do?

1. "What's wrong?" You go over and read the post with your friend.
2. "What's wrong?" You ask your friend.





During theater rehearsal, the same mistake keeps happening in the same part. Your friend's expression stiffens with each repeated rehearsal. After rehearsal, your friend picks up their bag. What would you do?





1. 'They seem tired from the rehearsal' You say bye, thinking they must be exhausted.
2. 'Are they getting upset because they keep making mistakes? I should reassure them.' I approach and offer comfort.





You're at an amusement park. To ride the popular attraction, you have to wait in line for a long time. What do you do?





1. "Waiting in line is also part of the fun!" You chat with your friend happily while waiting.
2. "Do we really have to wait this long?" You opt for a less popular ride with a shorter line.

Appendix B: Type Descriptions

LTFC	HAFC	LAFC	HTFC
Passionate Retriever 	Independent Sloth 	Smart Fox 	Serious Whale Shark 
You are a welcomed individual in any organization. With exceptional emotional empathy, you are able	You are not reliant on others and, in fact, prefer being alone. You do not prefer interaction with	You possess both clever and charming qualities, making you an essential individual in any	You are a thoughtful and intelligent individual. However, in interpersonal relationships, you

<p>to make others feel comfortable; you are also incisive, making you a great conversational partner.</p>	<p>others and have an independent nature, disliking both causing and receiving harm.</p>	<p>organization. Being deeply sensitive, you enjoy helping others; but it's important to be cautious of taking granted such kindness, both giving and receiving.</p>	<p>tend to approach others in a rational or pragmatic manner. In other words, your kind actions often stem more from a sense of moral duty rather than from altruism.</p>
<p><b>LTFS</b></p>	<p><b>HAOS</b></p>	<p><b>LAOC</b></p>	<p><b>HTFS</b></p>
<p>Quick-witted Hamster</p> 	<p>Mindlessly Floating Jellyfish</p> 	<p>Bright Baby Dolphin</p> 	<p>Tsundere Monkey</p> 
<p>Like a small and adorable hamster that is sensitive to its surroundings, you have the ability to accurately perceive the emotions of others. Hamsters are popular as pets due to their cuteness and lovable character. Similarly, you also bring strength to those around you as a cheerful individual. However, as your</p>	<p>Just like a free-floating jellyfish aimlessly drifting in the ocean, for you, freedom comes before interpersonal relationships. With a personality that prefers to stay alone, you may show some weakness in understanding others' emotions. While you pursue a free-spirited demeanor, your strong inclination</p>	<p>As a superstar in a zoo and one of the most sociable animals, dolphins are the most beloved confidant, just like you. You play the role of a beloved preacher within the community, but such actions can occasionally lead to frustration of others, so you must be careful.</p>	<p>You have a typical tsundere personality. While you prefer independence and being alone, you dislike being indebted to others. Therefore, when you receive something, you feel the need to give back even more. However, your acts of kindness often stem more from socially acceptable behavior rather than a genuine desire to</p>

<p>personality is too bright, it can sometimes be challenging for you to empathize when others are feeling down or sad.</p>	<p>towards doing things your own way can occasionally lead to problems.</p>		<p>give.</p>
<b>LTOC</b>	<b>HAOC</b>	<b>LAOS</b>	<b>HTOC</b>
<p>Sweet-hearted Turtle</p> 	<p>Leading Wolf</p> 	<p>Adorable Kitten</p> 	<p>Kind Magpie</p> 
<p>You are like a battery that brings healing just by being present. With exceptional empathy and a bright personality, people always want to be around you. However, be cautious, as your sometimes naive kindness may inadvertently cause frustration in others who perceive you as unaware of the ways of the world.</p>	<p>Like a lone wolf wandering through a snowy mountain, you are a highly independent individual who seeks to handle everything by yourself. Due to this trait, you may find it somewhat difficult to catch the emotions of others even when interacting with them. Still, you are someone who cannot simply overlook those in need and are filled with loyalty.</p>	<p>Like a healing cat that brings comfort with just a glance, you are someone overflowing with love. Along with your adorable appearance, you also display a quirky side; you must be careful not to simply become someone who is "just" lovable.</p>	<p>You are like the magpie from the Korean folktale "Heungbu and Nolbu," exceptionally adept at sensing others' gratitude and sympathy. Being deeply aware of the gratitude for the kindness you've received, you genuinely worry about others, but sometimes, rather than seeing others through the eyes of love, you may view them through the lens of give and take; caution is advised.</p>

LTOS	HAFS	LAFS	HTOS
<p data-bbox="201 281 370 317">Fluffy Panda</p> 	<p data-bbox="509 281 688 359">Overthinking Hedgehog</p> 	<p data-bbox="818 281 1013 317">Curious Parrot</p> 	<p data-bbox="1127 281 1370 359">Slowly Wandering Fish</p> 
<p data-bbox="201 747 488 1497">You are a cuddly panda that everyone wants to embrace with warmth and roundness. You are someone who expresses and understands love and gratitude well. However, because some people may find your focus on such positive emotions stifling, therefore prioritizing practical aspects may be necessary in some cases.</p>	<p data-bbox="509 747 797 1581">Like a hedgehog protecting itself with spines, you are the type of person who sets boundaries and prefers not to get involved with others unnecessarily. Perhaps due to this personality, you may show some deficiency in understanding others' emotions. However, you are adept at sensing frustration and readily lower your guard to engage with others when they feel frustrated.</p>	<p data-bbox="818 747 1105 1497">Like a clever parrot eager to learn from humans, you are a person filled with curiosity. Overall, possessing a kind nature, you often strive to catch and emulate others' positive emotions. However, be cautious, as sometimes your overly eager actions may lead to others feeling uncomfortable or resentful.</p>	<p data-bbox="1127 747 1414 1539">Like a fish swimming slowly in the sea, you sometimes show a weakness in reading others' emotions. People around you may find this aspect of you somewhat frustrating, so engaging in more social activities may help to address this. However, you excel in understanding and expressing gratitude, which makes those around you recognize that you are a good person.</p>

Appendix C: Total Responses

List of respondents ( 37 / 37 )



Respondent	Answer time	time taken
#37	2024-06-28 00:45:53	00:10:12
#36	2024-05-16 10:45:58	00:05:03
#35	2024-05-16 08:00:05	00:02:52
#34	2024-05-01 09:50:23	00:03:46
#33	2024-05-01 07:32:57	00:03:20
#32	2024-05-01 03:00:24	00:03:43
#31	2024-04-30 22:12:48	00:07:31

## Works Cited

- Anju. "Exploring the Impact of Social Media on Public Opinion Formation: A Comparative Analysis." *International Journal for Research in Applied Science and Engineering Technology* (2024): n. pag.
- Beins, Bernard C. "Social Desirability Bias." *WILEY Online Library*, 17 Oct. 2013, doi.org/10.1002/9781118339893.wbeccp501.
- Bouchard, Gene et al. "Parental intervention style and adult sibling conflicts: The mediating role of involvement in sibling bullying." *Journal of Social and Personal Relationships* 36 (2018): 2585 - 2602.
- Boyatzis, Chris J. and Reenu Varghese. "Children's emotional associations with colors." *The Journal of genetic psychology* 155 1 (1994): 77-85 .
- Carter, Travis J. and David Dunning. "Faulty Self-Assessment: Why Evaluating One's Own Competence Is an Intrinsically Difficult Task." *Social and Personality Psychology Compass* 2 (2008): 346-360.
- Chan, Eugene Y. and Yan Meng. "Color me moral: White and black product colors influence prosocial behaviors." *Psychology & Marketing* (2020): n. pag.
- Chea, Sarah. "No Infps Please, and Other Excesses of the MBTI Craze." *No INFJs Please, and Other Excesses of the MBTI Craze*, 27 Mar. 2022, koreajoongangdaily.joins.com/2022/03/27/business/industry/mbti-MyersBriggs-MyersBriggs-Type-Indicator/20220327172450438.html.
- Choosri, Noppon et al. "Color Association to Emotions of Chinese and Thai University Students." *Asia Social Issues* (2023): n. pag.
- Cooperrider, Kensy. "Universals and diversity in gesture: Research past, present, and future." (2020).
- Devi, S. Suneetha and A. Vidyadhara Reddy. "Customer Surveys Are Not Always Accurate: A Conceptual Study." *Journal Of Business Management & Social Sciences Research* 4 (2015): 45-48.
- Donnellan, M. Brent, and Richard E. Lucas. "PROJECTIVE TESTS ARE THE BEST APPROACH FOR MEASURING PERSONALITY." *WILEY Online Library*, 8 Jan. 2021, https://doi.org/10.1002/9781118851715.ch9.
- Garcia-Marques, Teresa and Diane M. Mackie. "Familiarity impacts person perception." *European Journal of Social Psychology* 37 (2007): 839-855.
- Gupta, Jiya and Ijar. "COLORS: THE EMOTIONS AND IMPRESSIONS THEY EVOKE." *International Journal of Advanced Research* (2020): n. pag.
- Herzig, A., Lorini, E. & Pearce, D. Social Intelligence. *AI & Soc* 34, 689 (2019). https://doi.org/10.1007/s00146-017-0782-8
- Kim, JinKyu. "Youth Suicide Rate Ranked 2nd in the Country... School-Family-Community Cooperation Needed." *Jeju Everyday*, 28 Nov. 2023, www.jejumaeil.net/news/articleView.html?idxno=331892#:~:text=%EB%B3%B4%EA%B1%B4%EB%B3%B5%EC%A7%80%EB%B6%80%20%EC%9E%90%EC%82%B4%EC



%98%88%EB%B0%A9%EB%B0%B1%EC%84%9C,%EC%97%90%EC%84%9C%20%  
EB%91%90%20%EB%B2%88%EC%A7%B8%EB%A1%9C%20%EB%86%92%EC%95  
%98%EB%8B%A4.

Lopes, Paulo N., et al. "Emotion regulation abilities and the quality of social interaction." *Emotion* 5.1 (2005): 113.

Mayer, J. D., & Salovey, P. (1997). What is emotional intelligence? In P. Salovey & D. J. Sluyter (Eds.), *Emotional development and emotional intelligence: Educational implications* (pp. 3–34). Basic Books.

Oh, Jaeyong. "Jeju English Education City International School Recruitment Rate Hits Highest Ever." *Chosun Ilbo*, 26 Oct. 2022, [www.chosun.com/national/regional/2022/10/26/FGV5OQOFDBAA3GRDX326WR5LFM/](http://www.chosun.com/national/regional/2022/10/26/FGV5OQOFDBAA3GRDX326WR5LFM/).

Park, Seong Woo. "'I Want to Die...' In the Diary of International School Students?" *Headline Jeju*, 6 May 2013, [www.headlinejeju.co.kr/news/articleView.html?idxno=179044](http://www.headlinejeju.co.kr/news/articleView.html?idxno=179044).

Rifkin, Glenn, and Benedict Carey. "Overlooked No More: Katharine Briggs and Isabel Myers, Creators of a Personality Test." *The New York Times*, The New York Times, 14 Oct. 2022, [www.nytimes.com/2022/10/14/obituaries/katharine-briggs-and-isabel-myers-overlooked.html#:~:text=myers%2Doverlooked.html,Overlooked%20No%20More%3A%20Katharine%20Briggs%20and%20Isabel%20Myers%2C%20Creators%20of,extroverts%20or%20thinkers%20or%20feelers](https://www.nytimes.com/2022/10/14/obituaries/katharine-briggs-and-isabel-myers-overlooked.html#:~:text=myers%2Doverlooked.html,Overlooked%20No%20More%3A%20Katharine%20Briggs%20and%20Isabel%20Myers%2C%20Creators%20of,extroverts%20or%20thinkers%20or%20feelers).

Santos, Henri C., Michael EW Varnum, and Igor Grossmann. "Global increases in individualism." *Psychological science* 28.9 (2017): 1228-1239.

Schade, Amy. "Avoid Leading Questions to Get Better Insights from Participants." *Nielsen Norman Group*, 17 Dec. 2017, [www.nngroup.com/articles/leading-questions/](http://www.nngroup.com/articles/leading-questions/).

Silveira, Jason M. and Frank M. Diaz. "The effect of subtitles on listeners' perceptions of expressivity." *Psychology of Music* 42 (2014): 233 - 250.

Trigueros, Rubén, et al. "Relationship between emotional intelligence, social skills and peer harassment. A study with high school students." *International journal of environmental research and public health* 17.12 (2020): 4208.

Twenge, Jean M et al. "Egos inflating over time: a cross-temporal meta-analysis of the Narcissistic Personality Inventory." *Journal of personality* vol. 76,4 (2008): 875-902; discussion 903-28. doi:10.1111/j.1467-6494.2008.00507.x

Winkel, Heather et al. "Seeing red as anger or romance: an emotion categorisation task." *Journal of Cognitive Psychology* 33 (2021): 581 - 594.

## **Enhancing Driver Efficiency By Nia Alavandi**

### **Introduction**

In today's automobiles, Advanced Driver Assistance Systems (ADAS) are widely available. These features help drivers with enhanced driving features by adding extra safety and making driving easier and comfortable. The ADAS features include things such as cruise control, lane departure warning, blind spot monitoring, and more. The goal of this paper is to determine how to make ADAS work best for everyone, making driving safer and more efficient. By studying these features and correlating it to driver age, it can be proven how ADAS makes driving easier and safer for everyone. This research could change the way we think about driving and technology in the future. It can aid in answering if a certain age group is prone to flag warnings thus providing insight into age and driver behavior

### **Abstract**

ADAS features are commonly used in a variety of newer vehicles. People within different age groups were tested anonymously for whether or not they could be sensed with ADAS features in use. This study raised questions about whether or not driver experience influences the automated driver features selected. Does the age reflect ADAS features in use? This study also develops knowledge of the positives and negatives of these driver assistance systems and establishes optimum user efficiency through the systems as well.

ADAS stands for Advanced Driver-Assistance Systems. These are technologies in vehicles that are designed to supplement a driver's capabilities and improve the safety and efficiency of driving. This paper explores the impact of Advanced Driver Assistance Systems (ADAS) on overall user efficiency in modern vehicles. ADAS incorporates a range of innovative features designed to enhance driver safety, driving comfort, and driver efficiency.

Through a review of current ADAS technologies, this study investigates how features such as cruise control, lane departure warning, blind spot monitoring, forward collision warning, and others contribute to improved driver efficiency. The analysis encompasses user experience, driver engagement, and increased awareness as key factors influencing overall efficiency. These findings suggest that the integration of ADAS features significantly enhances the driving experience, leading to a more efficient and safer interaction between the driver and the vehicles. This research highlights the transformative potential of ADAS in shaping the future of automotive tech.

### **Objectives and Purpose**

The objective of this paper is to research the transformative role of Advanced Driver Assistance Systems in modern transportation. ADAS features have emerged as crucial components reshaping the automotive setting by significantly enhancing user safety and elevating the driving experience. By conducting a thorough study of ADAS features, this paper aims to highlight their current advancements and future impact on transportation systems. By

understanding this analysis, a conclusion can be made on whether there is a correlation between age group and the amount of assistance ADAS features are giving that specific age range. Then, conclusions can be made on whether it's user experience or factors such as driving time that influence the features activation.

This research then aims to answer questions such as is there a correlation between ADAS features (of the 6 that were measured) enabled and age? Followed by what does this correlation mean in regards to future advancements? The hypothesis being tested is in relation to the first question in that this research aims to prove that there is a correlation between age and features enabled.

## **Materials**

The materials used in this study include the Intel Lidar Camera Sensor to track initial driving behavior in users, a survey, questioning users on which features were enabled, and the car itself. The camera sensor was unable to accurately read which features were activated at a time but it was able to measure user behavior in the car and was able to detect sounds.

## **Methods**

The study was conducted in order to track whether it's an age related issue of driving that is resulting in the users performance in the car. Not all of the features were enabled in certain drives so those were not accounted for.

The main study was on Advanced Driver Assistance Systems(ADAS). To measure the true impact and reliability that they hold on the human population. The camera recorded what took place within the car. This included mainly collision warnings. I was also able to turn the camera around to observe the outside of the car. This led to the question of this camera helping detect collisions. Then after the drive, a survey was provided to the users to record what features were enabled during their drive along with their age group. This data was scored and kept for later analysis.

In summary, there were observations made on what limits this camera had and what it could be used for potentially. Over time, with the camera, it was noticed that it was useful in detecting other objects. It was harder to notice things that weren't objects. For example, noises and user engagement.

In regards to the data, it helped conclude the correlation between age and features enabled which led to further analysis and conclusions to support the correlation.

## **Data Analysis**

A proper analysis can be drawn based on the research. The data suggests a significant correlation between age and features enabled. The younger age groups seem to have a higher number of ADAS features enabled in comparison to the older age groups. Of the age population shown in Figure 1, the majority of the population were people ages 45-55 which were 6 people. The average number of features that went off for this age group were 2.16 features, calculated

according to Figure 2. In comparison, the younger age group, ages 25-35, had an average of 4.75 features go off during their drive, also calculated according to Figure 2. This is over double the amount that went off for the older age group.

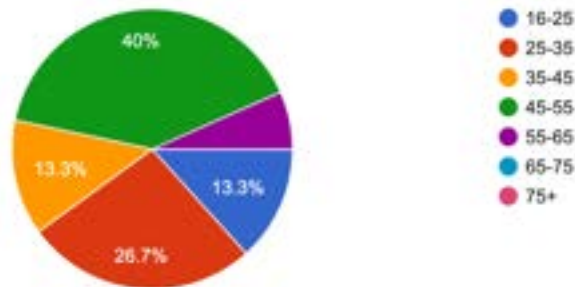

Figure 1 - Age Distribution For Total Population Tested

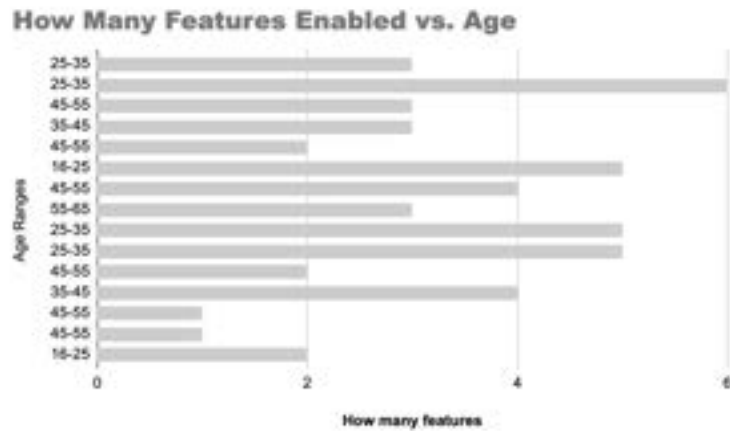

Figure 2 - Features Enabled Per Age Group Response (chronological)

Age Group	Number of Participants (Per Group)	Average Number of Features Enabled	Total Number of Features Enabled
16-25	2	3.5	7
25-35	4	4.75	19
35-45	2	3.5	7
45-55	6	1.8	11
55-65	1	3	3

65-75	0	N/A	N/A
75+	0	N/A	N/A

Figure 3 - Compiled Data Chart

Certain assumptions were made when analyzing the data produced. One prominent idea was that younger age groups may have less experience in driving which led them to have these features enabled during this drive. However, this is in contrast to the idea that if older drivers are experienced in the way we believed them to be, then why do some older drivers still have many features enabled? An assumption that can be made regarding that idea might be that it may have been a long period of time since an older driver has driven which may be causing the features to activate.

Another assumption is through a psychological approach, social norms from society which can pressurize younger drivers to voluntarily turn *off* these features rather than leave them on. If a younger driver wishes to seem more experienced then the individual can choose to deactivate these features to pose as a more experienced driver. This is a limitation of ADAS features.

### Variables

When looking at the variables involved in this experiment, the age of participants is a crucial independent variable which impacts the data. This variable represents the different age groups of the individuals participating in the study. It serves as the independent variable as it is manipulated or categorized by the study to assess its effect on other variables, particularly the activation of ADAS features. Another independent variable is driving experience. This variable may be categorized based on participants' levels of experience as novice, intermediate, or experienced drivers. It is also an independent variable as it is manipulated or categorized to examine its impact on ADAS feature activation.

Important dependent variables include the activation of the ADAS features and user efficiency. Activation of ADAS features refers to the specific ADAS features enabled during the participants' driving sessions. It is dependent on the age and driving experience of the participants, among other potential factors. User efficiency assesses the overall efficiency of participants' driving experiences while using ADAS features. It may encompass factors such as reaction times, adherence to traffic laws, and overall safety.

Finally when discussing the control variables, the methodology and driving environment (type of vehicle), remain the same throughout the experiment. Keeping the vehicle type consistent across participants ensures that any observed differences in ADAS feature activation are not due to variations in vehicle models or capabilities. For methodology, standardized procedures for data collection and analysis ensure consistency and reliability in the study's results.

## **Discussion**

The hypothesis that there is a valid correlation between age group and amount of features enabled is one that *is* proven by this study. The graphs pose as evidence to prove this claim and thus help prove the correlation as existing. There is significant data and evidence that proves this study's credibility and offers the conclusion, proving the hypothesis, to be correct.

## **Conclusions**

Based on the findings of the experiment, it is evident that there exists a correlation between age and the activation of Advanced Driver-Assistance Systems (ADAS) features. The data analysis reveals a consistent trend indicating that participants' age significantly influences the utilization of ADAS features during driving sessions. Younger participants, typically belonging to age groups characterized by less driving experience, tend to activate a higher number of ADAS features compared to older participants. This observation suggests that age plays a pivotal role in determining the intensity to engage with and rely on ADAS technologies while driving. Conversely, older participants, who may have accumulated more driving experience over time, might rely less on ADAS technologies, preferring traditional driving methods or relying more on their own judgment and skills developed through years of driving experience. This insight offers valuable guidance for future research and development efforts aimed at optimizing the design and deployment of ADAS technologies to enhance driving safety and efficiency for drivers of all ages

### **Works Cited**

- “ADAS: Everything You Need to Know.” *Car and Driver*,  
<https://www.caranddriver.com/research/a31880412/adas/>. Accessed 4 July 2024.
- “What is ADAS (Advanced Driver Assistance Systems)? – Overview of ADAS Applications.”  
*Synopsys*, <https://www.synopsys.com/automotive/what-is-adas.html>. Accessed 4 July 2024.

# **Assessment of different sectors impact on S&P500 using statistical modeling By Rohan Jha<sup>1,\*</sup> and Rishabh Jha<sup>2</sup>**

## **Abstract**

In this paper, we analyze the Standard and Poor's 500 (S&P500) variation with all eleven Standard and Poor's sectors. We combined real estate and communication with parent sectors such as real estate with financials and communication with technology, leaving effectively nine sectors. We performed statistical modeling and the regression analysis revealed that all sectors except utilities are statistically significant variables to impact S&P500. However, the impact of the technology sector is lower and only ~10% since the technology sector impact is driven by its being strongly correlated with other sectors except energy and financials. Thus, we subsequently used only three independent variables and they are technology, energy and financials. The regression analysis revealed they are statistically significant with p-values less than  $10^{-10}$  and R-square greater than 0.98. The technology sector covers over 50% of S&P variations, financial covers 30%, and Energy the remaining 15%. Thus, we could analyze S&P500 with key sectors like Technology, Financial, and Energy. Through economy, market and technological interconnection, most sectors are connected, financials offer access to capital and energy is a significant part of the cost across sectors. Energy is also driven by global supply & demand dynamics, geopolitics and OPEC (Organization of the Petroleum Exporting Countries) policies.

**Keywords: S&P500; S&P sectors; Statistical model; Collinearity; Regression**

## **Introduction**

The stock market offers an economic ecosystem where people trade stocks to grow their financial wealth. Stocks are a part of publicly traded companies. It is difficult to assess the stock market. People use indicators to see how the market is doing. Based on these stocks, we also have several indices, which are a combination of these stocks. One such indicator is the Standard and Poor's 500 (S&P 500). This is a stock market index tracking the stock performance of top 500 of the largest companies listed on stock exchanges in the United States. The S&P 500 thus gives an indication of how the market is doing.

S&P500 companies are also divided into different sectors. We have currently eleven sectors. These sectors are Materials, Industrials, Financials, Energy, Consumer Discretionary, Information Technology, Communication Services, Health Care, Consumer Staples, Utilities, and Real Estate. Two of them, real estate and communications started recently in 2018. Materials is the business of transferring raw materials to a usable good. One such company is Sherwin Williams and Dow Inc. The industrial sector makes capital goods such as building materials. Some companies include Boeing and 3M. The financial sector is a sector which deals with money such as banks and their subsidiaries. This includes Bank of America Corp. and Berkshire Hathway. The energy sector currently mostly helps extract energy sources from the Earth. Some example companies are Chevron and Exxon Mobile. Consumer Discretionary is a direct consumer to company transaction. This usually



deals with goods. Some examples include Tesla and Carnival. Information Technology is basically the companies who make parts and overall products that have tech belong in this sector. Some companies include Apple Inc. and Microsoft. Communication Services is the communication sector. This includes Verizon and Meta. Another one is Healthcare. This is pharmacy and anything that deals with human wellbeing. Some companies include Pfizer and Johnson & Johnson. The consumer staples sector is another sector that is the necessities goods or very common luxuries such as laundry detergent. Some companies include Walmart and Proctor & Gamble. Utilities is a sector that deals with necessary services. These include Gas, Electricity. Some examples are Duke Energy Corp. and Exelon Corp. Lastly is Real Estate. This deals with property. Some companies include Redfin Corp and Public Storage. Each of these sectors has several companies and thus analyzing these sectors along with S&P500 are complicated and complex.

Most people in the US invest in the market directly or indirectly through retirement or pension funds. Understanding variability in S&P500 is complicated and some level of understanding is important. Several researchers have attempted to predict S&P500 using numerous models. Zhong and Hitchcock (2021) combined technical indicators, fundamental financial data and sentiment analysis from textual data to predict S&P index and stock prices. Kim et al. (2023) discussed the use sentiment analysis on financial news and integrates these sentiments to predict S&P500 index. Phuoc et al. (2024) used machine learning to predict Vietnam stock market. Mukherjee et al. (2021) used deep learning to predict stock market. Fuster and Zou employed logistic regression and other machine learning techniques to forecast S&P 500 price levels, using a combination of technical indicators and market data. Rodriguez et al. (2024) used a machine learning approach to predict the S&P 500 absolute percent change.

In this paper, we are using a simple but foundational statistical model to understand the S&P500 index. We combined real estate and communication with parent sectors such as real estate with financials and communication with technology. This made our sector count from 11 to 9. We thus consider nine sectors to analyze S&P500 using statistical modeling. Analyzing all sectors to assess how S&P500 performs is complicated. We find the key impacting sectors to capture S&P500 behavior. Considering key sectors, we perform regression analysis to evaluate the S&P 500 with the least number of variables possible. The paper is organized in the following manner. It starts off with the Data and Methodology section. This is a basic overview of what we are going to do along with data source. Second is Results and Discussion. This shares the findings of the paper. Third comes Conclusion. This will summarize our results. This provides what drives the outcomes. will also talk about what might be the causes of these outcomes. We then have acknowledgements. This is who helped us by supporting, data, and revising. Lastly, we have references.

## **Data and methodology**

We gathered monthly and weekly S&P500 and indices for all eleven S&P sectors for the last 20-year data using yahoo finance and python code. We performed the following steps to develop results:

- **Data QC:** We first perform quality control of input data obtained from yahoo finance from other sources such as Nasdaq. We used S&P500 as a dependent variable and all 11 sectors as independent. Since real estate and communication sectors have been introduced recently, we have added them to their parent sectors such as real estate with financials and communication with technology. Thus, we had 9 key sectors.
- **Identify significant variables.** We then perform regression analysis using S&P500 as dependent variable and 9 key sectors as independent variables. We ran a regression analysis to identify the statistically significant variables with p-value less than 0.05. Variable with p-value greater than 0.05, we systematically remove one by one and eventually kept only statistically significant variables.
- **Reduce independent variables using collinearity:** Our objective with this model is to identify the key sectors impacting S&P500. We therefore leveraged the concept of collinearity to meet this objective. In statistics, collinearity occurs because the independent variables used in building the regression model are correlated with each other.
- **Validation of the model:** To test the feasibility of the model, we run the model with only key variables and assess their p-values for statistical significance. We also performed a blind test by randomly hiding 20% of data to test the prediction and use other 80% to build a model. Eventually the model is built with all 100% data. We subsequently validated the outcome by varying the time span such as 15 and 8 years along with 20 and also changed the frequency of data such as weekly along with monthly.
- **Assessment of impact:** Once we have a reliable regression equation, we assess the % contribution of the independent variable in forecasting. We first normalized the independent variables between 0 and 10. Accordingly we then adjusted the coefficients of these variables. The scaled coefficients provide the impact of these independent variables in the variability of the dependent variable. This enables us to identify high impacting variables.

## Results and Discussion

The S&P500 measures how the top 500 companies with respect to market capitalization are performing. These 500 companies are further divided into 11 groups called sectors. The market has been growing for the last 20 years with some dips along the way like the 2008-2009 financial crisis and 2020 Covid. These 11 sectors have grown differently, as shown in Figure 1. It is noteworthy that 2 of the 11 sectors, such as real estate and communication started recently and thus combined them with their parent sector. We combined the real estate with Finance and Communication with technology. The sector like Technology is growing over 20% annually. In contrast, the Energy sector is growing by less than 10% annually.

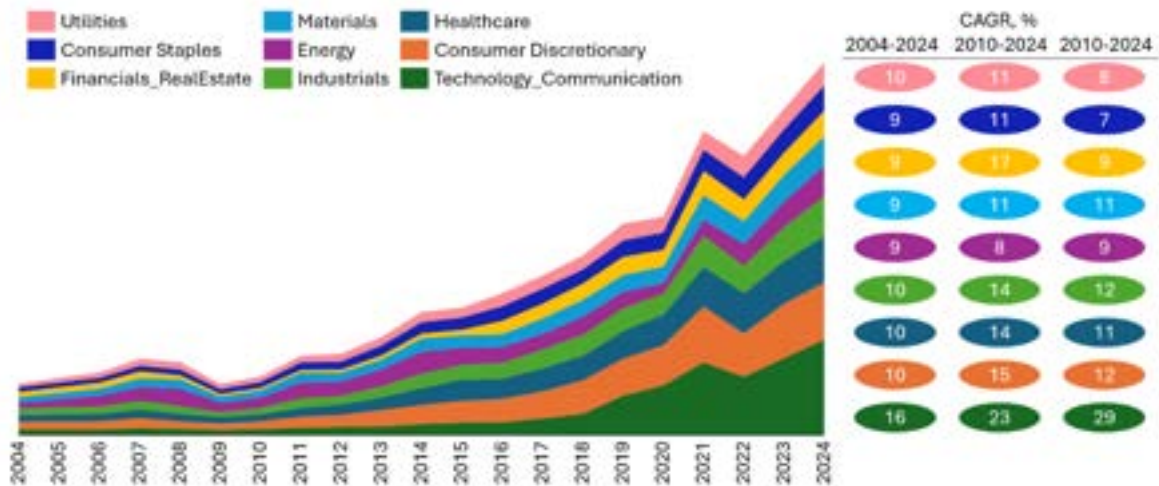

Fig 1: Index for different sectors for the last 20 years.

Although S&P500 is made up of 11 sectors, it is important to know which sectors drive the variability in the S&P500 based on historical data. To understand this, we performed regression analysis with S&P 500 as dependent variable and all 11 sectors as independent variables. We found that all sectors, but the Utilities sector, have p-values less than 0.05. This suggested that the Utilities sector is not statistically significant for S&P500. Thus, we then removed the utilities sector to keep only statistically significant variables. We performed regression again and found all p-values were less than 0.05. The regression output is as Multiple R as 0.998, R Square as 0.997 Adj R Square as 0.997, and Std. Error is 62.904. The regression equation is:

$$S\&P\ 500\ index = 457.207 + 2.150 * Tech + 3.64 * Finacials + 8.52 * Health + 6.177 * Consum$$

(1)

In Equation (1), the S&P 500 is the S&P500 US index and other sectors indices are independent variables.

Subsequently, we assessed the impact of these sectors on S&P500. Although the regression finds the equation with all the variables, it does not mean they impact the S&P500 the same way since these indices have different ranges. To evaluate the impact of various sectors, we normalized the range of dependent variables between 0 and 10 and the normalized coefficient accordingly is used as a measure of the impact. We found that the impact of the energy sector is the lowest with 1% and the highest being industrial at 21%. Surprisingly Technology, the biggest sector, has a relatively lower impact, only 11% on the S&P500.

Table 1: Impact of various sectors on S&P500 variability using regression equation (1).

Sector	Impact
Technology	11%
Energy	3%
Financials	9%
Healthcare	29%
Consumer Discretionary	7%

Consumer Staples	21%
Industrials	19%
Materials	0%

We investigated further to understand why the impact of the technology sector is lower in Table (1). This can happen if the impact of technology sector is captured by another sector, and we could test that using collinearity. Thus, we performed collinearity with all these sectors including S&P500. We found that all these sectors are mostly strongly correlated, as in Table 2. This means that we can run a regression with only three variables. We have selected three sectors as Technology, which has the biggest size, Financial and Energy, which is relatively less correlated with other variables. The regression output with both these variables being the significant variables is 0.980 R square as 0.960 Adj R Square as 0.959 and Std. Error as 233.816.

Table 2: Collinearity between different sectors for monthly data starting 2004

	S&P 500	Technology_Communication	Financials_RealEstate	Healthcare	Consumer Discretionary	Consumer Staples	Energy	Utilities	Industrials	Materials
S&P 500	1.00									
Technology_Communication	0.97	1.00								
Financials_RealEstate	0.96	0.92	1.00							
Healthcare	0.99	0.95	0.95	1.00						
Consumer Discretionary	0.96	0.96	0.94	0.99	1.00					
Consumer Staples	0.97	0.92	0.94	0.96	0.97	1.00				
Energy	0.68	0.60	0.65	0.68	0.61	0.70	1.00			
Utilities	0.97	0.82	0.95	0.96	0.97	0.99	0.87	1.00		
Industrials	0.98	0.85	0.95	0.96	0.98	0.98	0.71	0.97	1.00	
Materials	0.99	0.95	0.94	0.96	0.98	0.97	0.73	0.97	0.99	1.00

The regression equation is given as:

$$S\&P\ 500\ index = 538.450 + 7.775 * Technology + 10.448 * Energy + 18.844 * Financials \quad (2)$$

The accuracy of the regression equation (2) is tested using a blind test. They match reasonably well, as shown in Figure 2. The median error is ~3% and average error is ~5%.

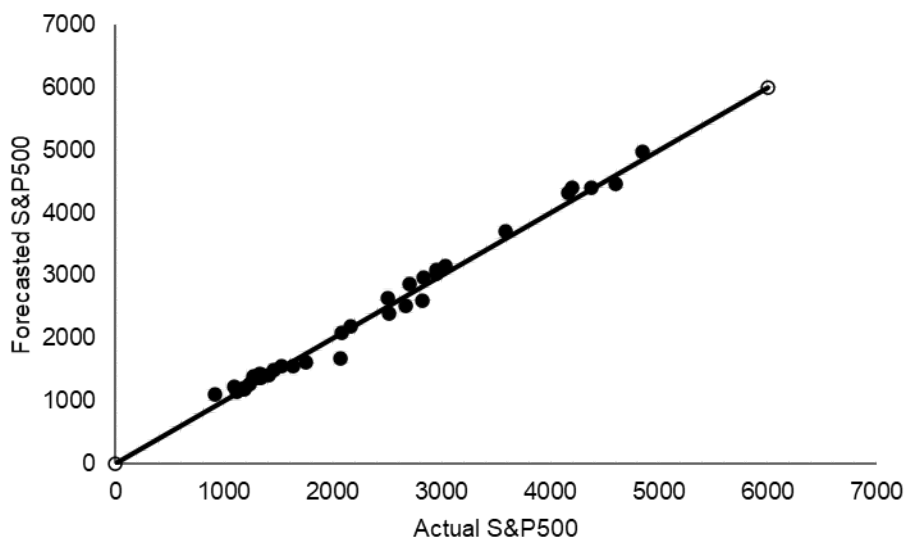

Fig 2: Actual and predicted S&P500 are shown with bullets. The solid line is 45-degree line.

We then tested the collinearity with data starting with 2010 and 2016 using monthly data and also weekly data starting 2016, as shown in Tables 3-5. In each of these cases, we found that all

sectors are strongly correlated except Energy. Subsequently, we took Technology and Financial as a measure for all other sectors and Energy as dependent variables and ran regression. These regressions resulted in these two variables being significant with p-values less than  $10^{-10}$  and R square as  $\sim 0.98$ . Regression equations are presented in equations (3) to (5). The regression output for data starting 2010 and monthly frequency is Mult R 0.977 R square 0.956 Adj. R Square 0.956 Std. Error 237.7 and the equation is:

$$S\&P\ 500\ 2010\ Monthly = 706.461 + 7.874 * Technology + 8.447 * Energy + 17.656 * Financials \quad (3)$$

The regression output for data starting 2016 and monthly frequency is Mult R 0.993 R square 0.986 Adj. R square 0.986 Std. Error 105.118. The regression equation is:

$$S\&P\ 500\ Monthly\ 2016 = 603.065 + 7.35 * Technology + 4.863 * Energy + 23.869 * Financials \quad (4)$$

The regression output for data starting 2016 and weekly frequency is Mult R 0.998 R square 0.996 Adj. R square 0.996 Std. Error 12.405 and the regression equation is:

$$S\&P\ Weekly\ 2016 = 355.183 + 15.301 * Technology + 1.761 * Energy + 25.407 * Financials \quad (5)$$

These statistically significant variables and similar equations provide confidence in the analysis further. We also estimated the impact of these three variables and found similar to previous cases. The Technology variable covers  $\sim 50\%$ , Financial covers  $35\%$ , and that of Energy covers  $\sim 15\%$ .

Table 3: Collinearity between different sectors for monthly data starting 2010.

	S&P 500	Technology_Communication	Financials_RealEstate	Healthcare	Consumer Discretionary	Consumer Staples	Energy	Utilities	Industrials	Materials
S&P 500	1.00									
Technology_Communication	0.87	1.00								
Financials_RealEstate	0.95	0.90	1.00							
Healthcare	0.99	0.95	0.95	1.00						
Consumer Discretionary	0.99	0.87	0.95	0.98	1.00					
Consumer Staples	0.98	0.93	0.98	0.99	0.97	1.00				
Energy	0.53	0.48	0.40	0.53	0.42	0.52	1.00			
Utilities	0.98	0.92	0.97	0.98	0.98	0.98	0.47	1.00		
Industrials	0.99	0.95	0.95	0.98	0.97	0.98	0.57	0.96	1.00	
Materials	0.99	0.96	0.93	0.98	0.97	0.97	0.59	0.95	0.98	1.00

Table 4: Collinearity between different sectors for monthly data starting 2016.

	S&P 500	Technology_Communication	Financials_RealEstate	Healthcare	Consumer Discretionary	Consumer Staples	Energy	Utilities	Industrials	Materials
S&P 500	1.00									
Technology_Communication	0.98	1.00								
Financials_RealEstate	0.96	0.92	1.00							
Healthcare	0.98	0.96	0.94	1.00						
Consumer Discretionary	0.97	0.87	0.94	0.93	1.00					
Consumer Staples	0.96	0.93	0.93	0.98	0.90	1.00				
Energy	0.58	0.48	0.54	0.61	0.38	0.63	1.00			
Utilities	0.99	0.90	0.92	0.94	0.87	0.98	0.54	1.00		
Industrials	0.98	0.94	0.94	0.96	0.92	0.94	0.66	0.88	1.00	
Materials	0.98	0.93	0.96	0.97	0.94	0.98	0.64	0.90	0.98	1.00

Table 5: Collinearity between different sectors for weekly data starting 2016.

	S&P 500	Technology_Communication	Energy	Financials_RealEstate	Consumer Discretionary	Healthcare	Consumer Staples	Utilities	Industrials	Materials
S&P 500	1.00									
Technology_Communication	0.90	1.00								
Energy	0.99	0.94	1.00							
Financials_RealEstate	0.95	0.83	0.84	1.00						
Consumer Discretionary	0.98	0.95	0.88	0.82	1.00					
Healthcare	0.96	0.95	0.88	0.87	0.96	1.00				
Consumer Staples	0.87	0.86	0.87	0.86	0.87	0.88	1.00			
Utilities	0.89	0.90	0.81	0.81	0.89	0.90	0.95	1.00		
Industrials	0.93	0.72	0.73	0.85	0.87	0.81	0.73	0.78	1.00	
Materials	0.91	0.86	0.81	0.88	0.84	0.79	0.88	0.75	0.98	1.00

Table 6: Impact of key sectors on S&P500 variability using regression equations (2-5).

Sector	Impact
--------	--------

Technology	~50%
Energy	~15%
Financials	~35%

**Conclusions**

In this paper, we analyzed the impact of different sectors on S&P500 variability using statistical modeling. We found that all sectors except utilities are statistically significant for S&P500. Subsequently, we also found that all sectors are highly correlated except Energy and Financials. Thus, we performed regression analysis required only three variables Technology and Financial as a measure for other sectors and Energy. These three are significant variables with  $R^2$  as ~0.98. The Technology variable covers ~50% of variations in the S&P500, Financials covers 35% whereas Energy sector covers the remaining ~15%. Thus, investors could focus on these key sectors to understand how S&P500 is behaving.

All sectors except energy and financials are strongly connected since they are in sync with the broader economy. For example, when the economy is doing well when consumer spending and investment increases. Also, technological advancement infuses growth in other sectors like healthcare and financials. Also, financials offer capital to companies and the economy. In contract, the Energy sector is driven by oil and gas prices. They are mostly driven by demand and supply dynamics, geopolitical events and OPEC (Organization of the Petroleum Exporting Countries) policies. These factors force the Energy sector to deviate from other sectors. In fact, Energy at times moves opposite to economy. High oil and gas prices increase production cost of all goods and services leading to negative correlations. Particularly, between 2015 to 2020, when most sectors were doing well, the Energy sector was struggling due to OPEC policy of oversupply to the market. This reduced the oil price and most companies in this sector were struggling.

**Acknowledgements**

Authors would also like to thank their parents for their support and encouragement. They acknowledge Abhinav Jha of Stanford University for input and suggestions.

### Works Cited

- Zhong, S., & Hitchcock, D. (2021). S&P 500 Stock Price Prediction Using Technical, Fundamental and Text Data. *Statistics, Optimization & Information Computing*, 9(4), 769-788.  
<https://doi.org/10.19139/soic-2310-5070-1362>
- Kim, J., Kim, H.-S., Choi, S.-Y. (2023). Forecasting the S&P 500 Index Using Mathematical-Based Sentiment Analysis and Deep Learning Models: A FinBERT Transformer Model and LSTM. *Axioms*. 12. 835. 10.3390/axioms12090835.
- Phuoc, T., et al. Applying machine learning algorithms to predict the stock price trend in the stock market – The case of Vietnam. *Humanit Soc Sci Commun* **11**, 393 (2024).  
<https://doi.org/10.1057/s41599-024-02807-x>
- Mukherjee, S., et al. (2021). Stock market prediction using deep learning algorithms. *CAAI Transactions on Intelligence Technology*. 8. 10.1049/cit2.12059.
- Fuster, A., & Zou, Z., Using Machine Learning Models to Predict S&P500 Price Level and Spread Direction. Our code is available at: <https://github.com/akfuster/CS229>.
- Rodriguez, F., et al. (2024). A machine learning approach to predict the S&P 500 absolute percent change. *Discover Artificial Intelligence*. 4. 10.1007/s44163-024-00104-9.

## **The Medical and Psychological Influence of Visual-Based Social Media on Adolescent Girls' Body Image By Mary Spain**

### **Abstract**

Social media is a communication nucleus that connects the entire globe. Clinical science associate professor Blair Burnette et al. state that social media is extremely popular with adolescents, with 92% of teens reporting daily usage, and visual-based sites like Instagram and Snapchat are more likely to be used by young girls. However, social media, namely these image-centered platforms, has raised concerns due to its promotion of unrealistic body standards and the health concerns they can entail, particularly for young girls. Senior developmental psychology lecturer Beth T. Bell et al. build on Burnette's research by emphasizing the concern present in girls when she states that female adolescents reported "...experiencing more sociocultural appearance pressures, higher levels of internalization, and increased body dissatisfaction, than boys" (281). This concept has gained much attention because consequences of social media's influence, according to An Vuong et al. in the *International Journal of Environmental Research and Public Health*, can be severe: depression, eating disorders, excessive exercise, and restrictive dieting have all been connected to poor body image (2). With these implications for both mental and physical health, questions have emerged regarding social media's impact on adolescent girls' body esteem, and how its negative influence can be limited.

### **Body Dissatisfaction**

Social media has great influence on how girls perceive their bodies, often in a pessimistic manner. Body dissatisfaction is defined as, "the negative self-evaluation of one's appearance", and its increase is linked with social media use at young ages (Vuong et al. 1). Photo-centric social media sites such as Instagram, Snapchat, and TikTok contain many edited or posed images, displaying the human body in a way that is not naturally obtainable. Bell et al. state, "Adolescents have described how they experience pressure to reproduce unrealistic appearance ideals in their own social media feeds" and builds on this idea while simultaneously highlighting the risk present to young girls by reporting, "...research indicates that girls are more likely to engage in appearance-related social media use than boys" (282). A study conducted in Melbourne, Australia further solidifies social media's role in body dissatisfaction and Bell's idea that girls are at particular risk. The study, which monitored body image in 1200 children from grades 7-10, found that, "girls reported significantly higher social media use, thin-ideal internalization, and body dissatisfaction...than boys" (Vuong et al. 6). The study builds on claims that visual-based platforms are notably damaging as well, stating, "The majority of participants used Instagram (90.89%) and Snapchat (90.72%)" (Vuong et al. 6). This research suggests a correlative relationship between image-centered social media usage in adolescent girls and increase in body dissatisfaction, which could have harmful consequences if left unchecked.

### **Eating Disorders**



One of the most drastic ramifications that social media induced body dissatisfaction can have is the development of eating disorders. These illnesses are mentally and physically devastating as well as difficult to break free from. Brookings is a nonprofit organization dedicated to research on public policy who requires their donors to undergo an integrity investigation and pledges to protect research findings regardless of donor agreement (“Donor Guidelines”). They reported that in the two years following the 2020 Covid-19 pandemic, adolescent eating disorder hospital admissions soared, with medical experts blaming a quarantine-induced growth in social media usage (Lai). This report is bolstered by the testimony of a 14-year-old girl in the peer-reviewed academic journal *Neuropsychiatric Investigation*. She claimed that following lockdown, she noticed many people gained weight and shared their diets on social media. These posts caused her to become obsessive over her weight and led to a downward spiral into an eating disorder, in which her BMI dropped to 10.8, which is below the 3<sup>rd</sup> percentile (Serdengecti et al. 38). Another study, conducted in Australia by eating disorder researcher and clinician Simon M. Wilksch et al., agrees with and builds on the idea of social media causing eating disorders by surveying a larger population containing 996 children from Grades 7 and 8 (96). Some of the key findings from the survey showed that girls scored significantly higher on every disordered eating scale, Snapchat was linked with increased frequencies of disordered eating, and all social media applications were connected with strict exercise habits in female adolescents (Wilksch et al. 99, 101). It is also important to note that girls with no social media accounts scored lower globally than those with multiple (Wilksch et al. 101). These findings give valuable insight into social media’s role in perpetuating eating disorders in young girls and the need to curb this issue.

### **The Body Positivity Movement**

However, social media can be utilized to improve body image, as seen in the body positivity movement. This movement has taken social media sites, notably Instagram, Snapchat, and Tiktok, by storm in response to the negative culture that social media typically creates surrounding the body. Associate professor Staci M. Zavattaro refers to body positivity as, “Any message, visual or written, that challenges dominant ways of viewing the physical body in accordance with beauty ideals and encourages the reclaiming of embodiment and control over one’s self-image” (285). Her research contradicts and adds a layer of complexity to Bell and Vuong’s findings by demonstrating how social media does not always shape body satisfaction negatively. Because of its versatility, social media is one of the biggest platforms for the movement. One advocate for this movement is Lizzo, an American pop singer and celebrity. She shares a multitude of content on her social media feeds about loving her larger body and embracing its differences (Zavattaro 281). The body positivity movement has been shown to elicit real-world changes as well. Instagram influencer Katie Sturino’s #MakeMySize movement has led to companies like Nike improving size inclusivity (Zavattaro 287). These changes are instrumental in helping young girls with larger bodies grow their body satisfaction by aiding in the creation of a society that is accepting of all body types. The body positivity movement offers

a refreshing view on how social media's connective potential and central place in society is used to improve body-related mental health rather than degrade it.

## **Conclusion**

Social media is a significant force on young girls' body image and could lead to serious health problems. It is a clear influence on body dissatisfaction, which in turn can lead to anxiety, eating disorders, and unhealthy practices. Young girls pose a particular risk since they are more likely to use visual-based social media and internalize its content. Recognizing this, many solutions have emerged to limit social media's negative influence. Age restrictions, commonly set at an age minimum of thirteen years to create an account, are largely ineffective, as the loopholes around them are evident and younger kids are commonly seen using these applications (Burnette et al.). As such, more intensive programs are necessary to control social media's destructive impact on young girls' body image. One solution is media literacy programs, which aim to raise awareness to social media's body toxicity, increase body esteem, and reduce internalization. One such program, Digital Bodies, reported, "...girls in the intervention group reported lower thin ideal internalization 1-week post-intervention, but this effect was not sustained at [8-week] follow-up" (Bell et al. 293). This demonstrates that while these curriculums can help short-term, more is needed to produce a long-lasting improvement. Overall, photo-centric social media's influence on adolescent girls' body dissatisfaction is apparent and can be definitively linked to mental and physical disorders. With these repercussions, a need for curriculums and changes in the applications themselves is vital to protect young girls throughout the world.

## Works Cited

- Bell, Beth T., et al. "Digital Bodies: A Controlled Evaluation of a Brief Classroom-based Intervention for Reducing Negative Body Image among Adolescents in the Digital Age." *British Journal of Educational Psychology*, vol. 92, no. 1, Mar. 2022, pp. 280–98. EBSCOhost, <https://doi.org/10.1111/bjep.12449>.
- Burnette, C Blair et al. "'I don't need people to tell me I'm pretty on social media:' A qualitative study of social media and body image in early adolescent girls." *Body image* vol. 23 (2017): 114-125. doi:10.1016/j.bodyim.2017.09.001.
- "Donor Guidelines." *Brookings*, <https://www.brookings.edu/support-brookings/donor-guidelines>. Accessed 25 October 2023.
- Lai, Samantha. "How do we solve social media's eating disorder problem?" *Brookings*, 24 February 2022, <https://www.brookings.edu/articles/how-do-we-solve-social-medias-eating-disorder-problem/>.
- Serdengeçti, Nihal, et al. "Could the COVID-19 Pandemic Be a Trigger for Eating Disorders?" *Neuropsychiatric Investigation*, vol. 61, no. 1, Mar. 2023, pp. 37–39. EBSCOhost, <https://doi.org/10.5152/NeuropsychiatricInvest.2023.22022>.
- Vuong, An T et al. "Social Media Use and Body Dissatisfaction in Adolescents: The Moderating Role of Thin- and Muscular-Ideal Internalisation." *International Journal of Environmental Research and Public Health* vol. 18,24 13222. 15 Dec. 2021, doi:10.3390/ijerph182413222.
- Wilksch, Simon M., et al. "The Relationship between Social Media Use and Disordered Eating in Young Adolescents." *International Journal of Eating Disorders*, vol. 53, no. 1, Jan. 2020, pp. 96–106. EBSCOhost, <https://doi.org/10.1002/eat.23198>.
- Zavattaro, Staci M. "Taking the Social Justice Fight to the Cloud: Social Media and Body Positivity." *Public Integrity*, vol. 23, no. 3, May 2021, pp. 281–95. EBSCOhost, <https://doi.org/10.1080/10999922.2020.1782104>.

## **Period Products: America's Hidden Economic Injustice By Mary Spain**

### **Abstract**

Corporate greed is nothing new to America. From low wages to unsafe conditions, businesses have devised countless immoral methods to raise profits. In the past, leaders such as late President Franklin D. Roosevelt made great efforts to reign in the abuses of selfish industries, condemning them as, “[knowing] only the rules of a generation of self-seekers” (22). Nevertheless, this corruption persists today, exemplified in scandals such as when the car company Volkswagen purposefully designed their cars to falsify emission records in order to meet clean air standards (Thomas and Chaleff 63). However, while public outrage typically helps hold these companies accountable, the American population has not only been aware of, but acquiesced to an equally large display of greed in the menstrual product industry. Tulane University Medical Student Udit Dave et al. describe this multi-billion-dollar business as having reaped enormous profits from items that women have no choice but to purchase (221). New York representative Carolyn Maloney and the Democratic United States Joint Economic Committee emphasize Dave et al.’s work by describing the financial vulnerability already present in American women, stating, “the pay gap adds up to...roughly \$500,000 over a lifetime...[contributing] to higher poverty rights among women” (1). However, little has been done by the United States government to correct this economic injustice due to the nation’s history of unrestrictive economic policy. Overall, though, the need for price regulation of these products outweighs any previous policy patterns due to the economic barriers many women face when purchasing menstrual products, price fluctuations during economically unstable periods, and the health hazards posed by alternative methods women use when they cannot afford these items.

### **Taxation & Governmental Barriers**

To begin, all American women, regardless of socioeconomic status, face challenges when purchasing menstrual products due to the unfair taxes. Political Scientist Mackenzi Lafferty defines the pink tax as, “...an extra amount that women pay daily as consumers for products and services that are similar or equal in merit to comparable men’s products” (56). This economic inequality that American women face also extends itself to menstrual products. Although there is no exact male comparison for period products, Lafferty develops this pink tax definition by comparing the taxation of period products to Viagra, a health care item for men (59). She reports that while menstrual products are still taxed as luxury items in many states, medications for men’s health like Viagra are commonly included in health care plans to increase affordability (Lafferty 59). Dave et al. bolster Lafferty’s work on this gender-based tax discrimination, stating, “...individuals who menstruate...face further financial strains through state sales taxes on feminine hygiene products. Many of these taxes are imposed in states that do not levy taxes on products that are geared toward consumption by men, such as condoms with spermicide and medication for erectile dysfunction” (222). Considering that selective taxes are intended to

“...[discourage] undesired consumption”, it becomes evident that a misogynistic system is currently operating in the U.S. economy, as period products are a health necessity for all women and whose consumption should therefore be actively encouraged (Lafferty 59). These excess taxes not only pose a grievance for all American women but can become detrimental when considering the limited finances of low-class women. Overall, millions of American women of all economic statuses face challenges when they are forced to purchase these health necessities that are taxed as frivolous luxuries, an economic injustice that is long overdue for improvement.

### **Challenges Faced by Low-Class Women**

Moreover, women of low socioeconomic status in America face additional barriers when purchasing menstrual products. When surveying low-income women in St. Louis, Missouri, Saint Louis University Associate Professor Dr. Anne Kuhlmann Sebert, who specializes in health and behavior sciences, et al. found that, “Nearly two thirds (64%) of women were unable to afford needed menstrual hygiene supplies during the previous year. Approximately one fifth of women (21%) experienced this monthly” (238). Sebert et al.’s work demonstrates that the current methods in place to increase accessibility, such as having shelters distribute menstrual products, are still woefully inadequate. In addition, masters’ students Ashley Rapp and Sidonie Kilpatrick at the University of Michigan School of Public Health, a nationally recognized institution that has received accreditation from the Council on Education for Public Health since 1946, expand on Sebert et al.’s work (“Michigan Public Health and Accreditation”). They found that menstrual products were unable to be purchased using food stamps or other government benefits (Rapp and Kilpatrick). This lack of government aid forces low-socioeconomic status women to allocate part of what little income they may have to menstrual products, which can in turn force them into choosing whether to buy these products or other necessities for themselves or their families. Margaret L. Schmitt, with a master’s in public health from Columbia University, et al. also contextualize Rapp and Kilpatrick’s work by relating these obstacles to the Covid-19 pandemic (1-2). They found that the increased financial instability and store shutdowns during the pandemic caused nearly all the women surveyed to report challenges in purchasing period products (Schmitt et al. 4) As these participants were affected despite being from all ranges of income, it becomes evident that the Covid-19 pandemic undoubtedly worsened the conditions for lower class especially. The present standard for menstrual aid from the American government is extremely inadequate for many low-income women, forcing them to choose what necessities to buy and leaving them virtually stranded in times of national crisis.

### **Health Risks**

When women cannot afford menstrual products, they often turn to makeshift alternatives that can lead to serious health consequences. In their survey of low-income women, Sebert et al. found that, “One third of women had used something other than disposable pads or tampons during menstruation, such as strips of cloth, rags, tissues, or toilet paper” (240). Others reported alternatives included paper towels and children’s diapers. (Sebert et al. 240). As these products

are not made for menstruation, their use for such leads to many physical consequences. Rapp and Kilpatrick further Sebert et al.'s findings by exploring these consequences, stating, "Products like rags, paper towels, and reused pads put menstruators at a heightened risk for urogenital infections, such as urinary tract infections and bacterial vaginosis. These products are also associated with outcomes such as skin irritation, vaginal itching, and white or green discharge" (Rapp and Kilpatrick). Dave et al. also delve into the more serious consequences of using alternative materials, finding that they can lead to, "fertility issues, toxic shock syndrome, and cervical cancer" (223). These health conditions not only threaten the physical health of American women as a whole, but in particular can keep low-income women in a state of economic dependence through medical expenses and lost working productivity due to illness. Concerning mental health, Schmitt et al. state that women who had experienced an inability to access period products reported, "...episodes of embarrassment, low self-esteem, and depression" (6). Their work complexifies the issue of these health repercussions as a whole by demonstrating that they affect mental health as well as physical. All in all, women who cannot afford period products are at risk for serious implications for overall health, proving that the current economic regulation of period products not only threatens the economic states of American women but their lives as well.

### **Economic Shifts & Period Products**

Furthermore, an unstable American economy has put economic strain on consumers in the past and continues to do so today, demonstrating the need to regulate necessities like menstrual products. U.S. News & World Report Contributor Tim Smart found that the level of inflation rose to an astonishing 9% in 2022, and although that rate has dropped since then, the economy today remains noticeably inflated (2). With the rising prices that follow inflation, especially in years like 2022, goods become more difficult to purchase for many Americans, especially the low-class. The U.S. Bureau of Labor Statistics build upon and specify Smart's findings by looking into the Consumer Price Index (CPI), "... a measure of the average change over time in the prices paid by urban consumers for a market basket of consumer goods and services" ("Consumer Price Index"). They found that for all items less food and energy, which include menstrual products, "Prices...increased 3.9 percent from January 2023 to January 2024..." ("Consumer Price Index"). Although this is a decreased rate compared to 6.0 percent from January 2021 to January 2022, this work demonstrates that the average prices of many goods, including period items, continue to be higher than average today ("Consumer Price Index"). The future of the American economy also remains uncertain. Smart states the rate of unemployment could increase in 2024 and that China, a key participant in the global economy, is experiencing an economic downturn that could cause problems across the world (3,4). Having experienced drastic economic challenges in the past, and with today's national market remaining precarious, the need to monitor the prices of period products so that women can consistently access these necessities is clear.

## Conclusion & Solutions

Overall, a regulation of menstrual products proves itself necessary due to barriers in taxation and government benefits that women face, the struggle for low-class Americans to afford them, the physical and mental consequences of being unable to purchase period products, and the financial instability caused by a constantly changing economy. With these implications for millions of American women, it is imperative that this economic injustice be corrected. Recent legislation in Scotland provides a radical solution to this issue. In 2021, the Scottish government implemented the Period Products (Free Provision) (Scotland) Act 2021, which, "...places duties on local authorities and education providers to make period products obtainable free of charge for anyone who needs to use them, building on existing voluntary policies" ("Period Products (Free Provision) (Scotland) Act 2021: Equality Impact Assessment"). While this solution would virtually eradicate the inaccessibility of period products, it is not feasible due to the fact that Scotland's population is a small fraction of America's, and hence the government spending required for the United States to enact this law would be much larger. Eliminating the luxury tax on menstrual products throughout all states also presents a solution. However, this may pose challenges in determining what types of period products are exempt from the tax, as well as possible constitutional objections from those who believe that certain tax legislations should be under state control.

As such, the most beneficial and efficient solution is installing a price ceiling, which, "creates a government-mandated maximum price that sellers can charge their customers", upon all menstrual products ("The Economics of Price Controls - the Economics of Price Controls - United States Joint Economic Committee"). This recognizes the necessity of menstrual products for the lives of American women by discouraging excessively high prices. This concept does pose limitations in the fact that the government may be reluctant to lose a large amount of profit in the industries that are regulated. However, as Franklin D. Roosevelt stated in his inaugural address during the Great Depression, "...our true destiny is not to be ministered unto but to minister to ourselves and to our fellow men" (22). The U.S. government is, above all, to support the welfare of its people and, as such, morally obligated to support this legislation. It may also encounter opposition from groups who are against government interference in economics, such as the Republican Party, who claim, "Price controls can...cause shortages which lead to arbitrary rationing and, over time, reduce product innovation and quality" ("The Economics of Price Controls - the Economics of Price Controls - United States Joint Economic Committee"). However, the main argument posed by the Republican Party is that such regulations would stunt innovation ("The Economics of Price Controls - the Economics of Price Controls - United States Joint Economic Committee"). This may be true for some cases, but since menstrual products have been standardized for many years and are not nearly as rapid changing as other industries, such as pharmacy, there is much less of a need for concern about said innovation. A final limitation to this solution is a reluctance of American women to petition for this regulation due to the stigma surrounding menstruation, which, "...associates [it] with uncleanness and disgust..." (Rapp and Kilpatrick). This stigma may seem difficult to overcome, but it is imperative that not

only American women, but Americans as a whole, adopt an attitude of moral courage, said to be, "...the one essential, vital quality of those who seek to change a world which yields most painfully to change", to confront it (Thomas and Chaleff 58). Moral courage is defined as, "...the capacity to overcome the fear of shame and humiliation in order to...denounce injustice..." (Thomas and Chaleff 60). In order to receive economic justice and win easy access to the essential items they deserve, all Americans must gain the moral courage encourage to arouse public attention on the need for price controls of menstrual products. To do so will not only greatly aid low-income American women and their families, but help every woman in the U.S. afford these vital items and experience an overall improved quality of life, knowing that their specific needs are acknowledged and cared for.



## Works Cited

- “Consumer Price Index.” *U.S. Bureau of Labor Statistics*, <https://www.bls.gov/cpi/>. Accessed 20 March 2024.
- Dave, Udit et al. “An Overview of Period Poverty and the Public Health Benefit Impact of Providing Free Feminine Hygiene Products.” *International Journal of Health Services Research and Policy*, vol. 7, no. 2, July 2022, <https://doi.org/10.33457/ijhsrp.971839>.
- Lafferty, Mackenzi. “The Pink Tax: The Persistence of Gender Price Disparity.” *Midwest Journal of Undergraduate Research (MJUR)*, no. 11, Jan. 2019, pp. 56–72. EBSCOhost, [research.ebsco.com/linkprocessor/plink?id=a057b679-cffe-3b39-84c5-ea6ba5ec524c](https://research.ebsco.com/linkprocessor/plink?id=a057b679-cffe-3b39-84c5-ea6ba5ec524c).
- Maloney, Carolyn. “The Pink Tax: How Gender-Based Pricing Hurts Women’s Buying Power.” *Joint Economic Committee*, Dec. 2016, [https://www.jec.senate.gov/public/\\_cache/files/8a42df04-8b6d-4949-b20b-6f40a326db9e/the-pink-tax---how-gender-based-pricing-hurts-women-s-buying-power.pdf](https://www.jec.senate.gov/public/_cache/files/8a42df04-8b6d-4949-b20b-6f40a326db9e/the-pink-tax---how-gender-based-pricing-hurts-women-s-buying-power.pdf).
- “Michigan Public Health and Accreditation.” *University of Michigan School of Public Health*, <https://sph.umich.edu/about/accreditation.html>. Accessed 21 March 2024.
- “Period Products (Free Provision) (Scotland) Act 2021: Equality Impact Assessment.” *Scottish Government*, <https://www.gov.scot/publications/period-products-free-provision-scotland-act-2021-equality-impact-assessment/>. Accessed 20 March 2024.
- Rapp, Ashley and Sidonie Kilpatrick. “Changing the Cycle: Period Poverty as a Public Health Crisis.” *University of Michigan School of Public Health*, <https://sph.umich.edu/pursuit/2020posts/period-poverty.html>. Accessed 21 March 2024.
- Roosevelt, Franklin D. "Inaugural Address." 1933. *AP Seminar Performance Task 2: Individual Research-Based Essay and Presentation*, compiled by College Board, 2024, pp. 22-24.
- Schmitt, Margaret L., et al. “‘I Stretch Them out as Long as Possible:’ U.S. Women’s Experiences of Menstrual Product Insecurity during the COVID-19 Pandemic.” *BMC Women’s Health*, vol. 23, no. 1, Apr. 2023, pp. 1–11. EBSCOhost, <https://doi.org/10.1186/s12905-023-02333-z>.
- Sebert, Anne Kuhlmann et al. “Unmet Menstrual Hygiene Needs Among Low-Income Women.” *Obstetrics & Gynecology*, vol. 133, no. 2, Feb. 2019, pp. 238–44. EBSCOhost, <https://doi.org/10.1097/AOG.0000000000003060>.
- Smart, Tim. “Will the U.S. Economy Surprise Again 2024?” *U.S. News & World Report - The Report*, Dec. 2023, pp. C4–6. EBSCOhost, [research.ebsco.com/linkprocessor/plink?id=71f21adf-31ba-31cc-9443-9aa6c52b7eba](https://research.ebsco.com/linkprocessor/plink?id=71f21adf-31ba-31cc-9443-9aa6c52b7eba).
- “The Economics of Price Controls - the Economics of Price Controls - United States Joint Economic Committee.” *Joint Economic Committee*, <https://www.jec.senate.gov/public/index.cfm/republicans/2022/9/the-economics-of-price-controls>. Accessed 21 March 2024.
- Thomas, Ted, and Ira Chaleff. "Moral Courage and Intelligent Disobedience." *AP Seminar Performance Task 2: Individual Research-Based Essay and Presentation*, compiled by

# Precision in Prediction: A Comparative Analysis to Optimize LSTM Models for Stock Prices By Darsh Jaganmohan

## Introduction

Predicting future stock prices accurately remains a critical challenge in the ever-expanding financial landscape, characterized by volatility and dynamic nature of the market. The complexities of market movements often surpass traditional statistical approaches and traditional machine learning models, leading to suboptimal predictive accuracy.[1]. This study aims to bridge these gaps by leveraging advanced machine learning techniques, focusing on the comparison of Linear Regression, Multivariable Regression, Random Forest, and Long Short-Term Memory (LSTM) models. This study aims to demonstrate the complex relationship between market sentiment, technical indicators, and stock price predictability. To support this study, the research employs sentiment analysis, leveraging news data sourced from NewsData.io[2], along with an evaluation of the Moving Average Convergence Divergence (MACD)[3] indicator's effectiveness in assessing technical robustness.

This study systematically evaluates the predictive power of various models using historical data from Yahoo Finance[4], focusing on their accuracy in forecasting stock prices. This accuracy is measured by the Mean Squared Error (MSE), which is the average of the squares of the errors or deviations between the actual stock prices and the predictions made by the models. A lower MSE indicates a model with better predictive accuracy, as the lower MSE signifies smaller discrepancies between the predicted and actual values. Integrating sentiment analysis, which evaluates the market's emotional and psychological conditions, with the MACD indicator, a recognized instrument for tracking market momentum and trends, can potentially offer a more comprehensive view of market dynamics. This study offers insightful information based on financial analytics and market behavior by assessing these models against their MSE metrics, which has the potential to completely transform the algorithms used in stock prediction[5].

## Related Works

The implementation of advanced machine learning models has significantly improved stock price prediction techniques. Financial markets involve large amounts of complicated data, and sophisticated approaches have gradually replaced traditional statistical analyses.

## Machine Learning Models in Stock Prediction

Various machine learning models, including Random Forest, Multivariable Regression, Linear Regression, and Long Short-Term Memory (LSTM) models, have been successful in predicting stock values in recent studies. Notably, LSTM models have gained significant acceptance for their capacity to identify long-term dependencies in time-series data, which is an essential feature for examining stock market trends[6][7]. A more thorough understanding of stock price movements is made possible by the distinctive advantages of each model, as shown

by comparative analysis.

### **The Role of Sentiment Analysis**

Sentiment analysis can extract market sentiment from news articles and social media posts, and has become increasingly popular for incorporating sentiment analysis into predictive models. This method can potentially improve forecasting accuracy by offering perceptions of the emotional conditions of the market [8][9]. Combining sentiment analysis with established financial indicators, such as the Moving Average Convergence Divergence (MACD), has improved model performance by providing hidden signals for changes in stock prices. [10].

### **Challenges and Opportunities**

Despite these developments, stock price prediction still faces numerous challenges despite these developments, such as data noise, market volatility, and model overfitting. However, combining sentiment analysis and technical indicators with machine learning offers a promising possibility for creating prediction models that are more accurate and reliable. The industry's dedication to improving the prediction accuracy of stock prices is demonstrated by the move towards more sophisticated models that incorporate a variety of data sources, including high-frequency trading data and global economic indicators[11].

This study highlights the prediction of stock prices using advanced machine learning and deep learning models leading the way. Combining sentiment analysis with technical indicators is a promising approach to further improve the predictive power of these models and provide a more comprehensive picture of investor sentiment and market dynamics.

### **Methodology**

#### **Data Collection**

This research used historical stock prices from Yahoo Finance and sentiment data from NewsData.io, for August 14, 2023, and February 12, 2024, from well-known companies such as Apple, Google, Microsoft, Amazon, Tesla, and Meta[12][13]. The Financial data were retrieved using the yfinance library, which provided a large dataset for this study.[14].

#### **Sentiment Analysis**

The sentiment scores for Sentiment Analysis were calculated using the news articles related for the selected companies, retrieved via NewsData.io's Historical data API[15]. This method combined quantitative data with qualitative insights to analyze the effect of market sentiment on stock prices. This means we're not just looking at quantitative data like stock prices or trading volumes; we're also looking at qualitative insights like what people are writing and saying in the news. By examining the words used in these news articles, the study measures the overall feeling or mood in the market – like whether people are positive or negative about these companies. This way, we mix the hard facts of the market with the softer,

more opinion-based side of things you see in the news, to get a fuller picture of what might make stock prices go up or down.

### Model Development and Evaluation

This work focuses on evaluating various predictive models, including Simple Linear Regression, Multivariable Regression, Random Forest, and Long Short-Term Memory(LSTM) models, culminating in the development of a Bidirectional Long Short-Term Memory(LSTM) model[16]. This final model uses the Moving Average Convergence Divergence (MACD) indicator and the hyperparameter tuning as outlined in Table X, to identify potential stock price movements[17]. During the hyperparameter tuning process, we tested a series of Bidirectional LSTM models with different configurations to identify which setup best predicts stock prices. We varied the number of LSTM units, the dropout rates to prevent overfitting, and the learning rate which controls the speed at which the model learns. Each trial was evaluated using the Mean Squared Error (MSE), a measure of how closely the model's predictions match the actual stock prices. The trial with the lowest MSE, which signifies the smallest average prediction error, was selected as the best model. This process ensures we select a model that is well-tuned and most likely to provide accurate predictions. (Refer to Table 1: Hyperparameter tuning details in the later section.)

### Results

Our evaluation of various machine learning models for stock prediction, integrating financial data and sentiment analysis, revealed significant disparities in performance. The comparison was primarily based on Mean Squared Error (MSE) as a metric for accuracy assessment. Below, we present the visual representation of the comparison through plots depicting the predicted versus actual stock prices for each model.

### Linear Regression

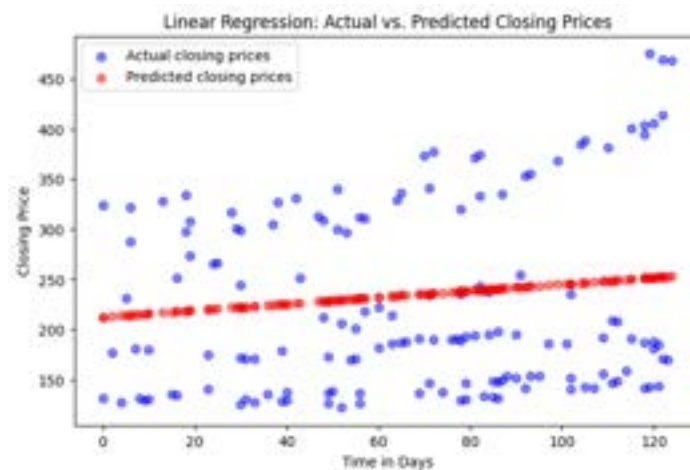

Figure 1: Linear Regression Model.

The actual prices and predicted prices are visibly distinct, indicating that the model's predictions are not closely aligned with the actual values. The linear regression model resulted in

a high Mean Squared Error (MSE) of 8143.439435841439, which further suggests that this model has a large average squared difference between the estimated values and what is estimated, implying poor model performance in this instance.

### Multivariable Regression

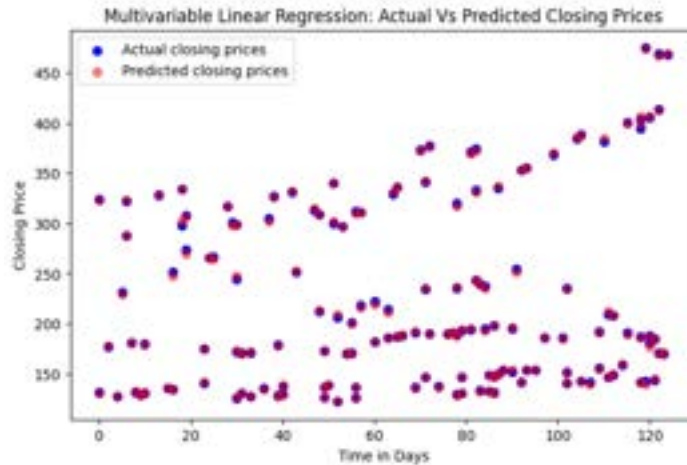

Figure 2: Multivariable Regression.

The points appear more closely aligned along a line, which suggests a better fit compared to the previous model. With an MSE of approximately 2.05, the model's predictions are more accurate, showing a significantly lower average squared difference between the predicted and actual values. This indicates a stronger predictive performance.

### Random Forest Model



Figure 3: Random Forest Model.

The scatter plot indicates a closer alignment between the actual and predicted closing prices compared to the linear model, yet there remains some dispersion. The Random Forest

model's MSE of 9.181053484740085, while significantly lower than the linear regression, suggests that while the model has improved predictive accuracy, there are errors and further optimization may still be beneficial.

### Linear Regression Model with Sentiment Analysis



Figure 4: Linear Regression Model with Sentiment Analysis.

The chart suggests a considerable discrepancy between the actual and predicted closing prices in the linear regression model with sentiment analysis, with the predictions not closely mirroring the actual values. The Mean Squared Error (MSE) of 5214.257518177014 indicates the model's average error magnitude is substantial, which might point to over-simplification in the model or non-linear patterns in the data that the model cannot capture.

### Multivariable Regression Model with Sentiment Analysis



Figure 5: Multivariable Regression Model with Sentiment Analysis.

The visualization indicates that the multivariable linear regression model with sentiment analysis, with a MSE of 4.464519821824686, displays a noticeable variance between the actual and predicted closing prices, though to a lesser extent compared to a simple linear model. The lower MSE suggests that incorporating multiple variables and sentiment analysis has improved the model's predictive accuracy, yet there's still room for improvement, possibly through more complex modeling or additional feature engineering.

## Random Forest Model with Sentiment Analysis

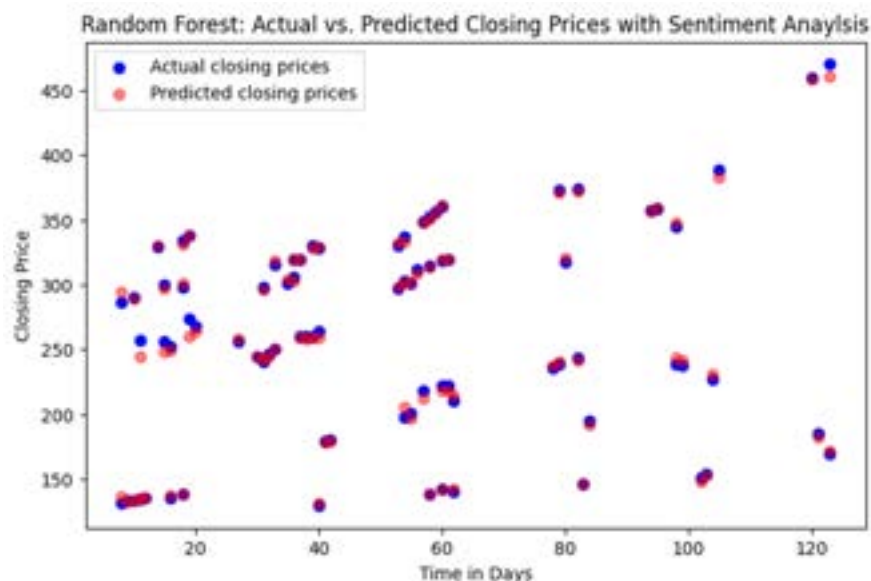

Figure 6: Random Forest Model with Sentiment Analysis.

The chart suggests that the Random Forest model with sentiment analysis features offers a better fit between the actual and predicted closing prices than previous models, as seen by the closer alignment of data points. Despite this improvement, with an MSE of 13.425193631516159, the model still shows some discrepancies, indicating potential areas for optimization, such as feature selection or model complexity adjustments.

## LSTM Model with Sentiment Analysis

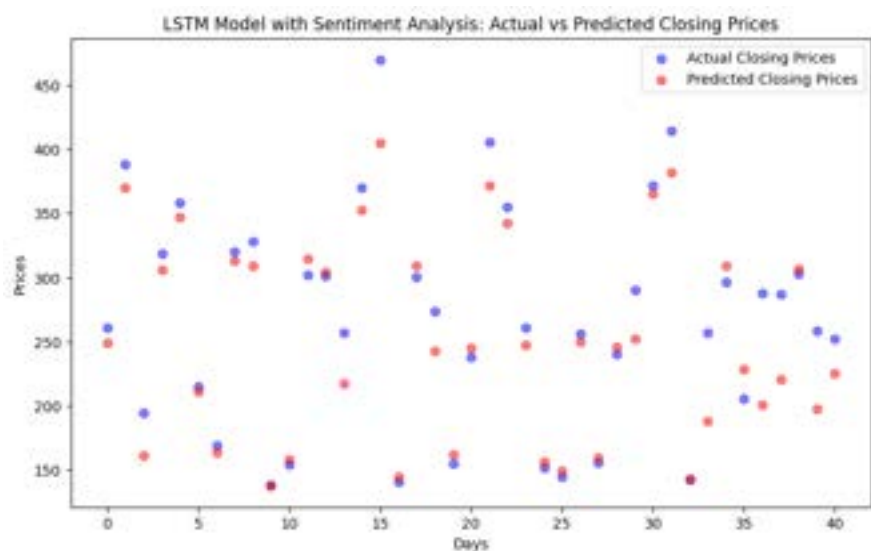

Figure 7: LSTM Model with Sentiment Analysis.

The chart for the LSTM model with sentiment analysis shows a mixed degree of correlation between actual and predicted stock prices, with some predictions closely matching

the actual prices while others diverge significantly. The MSE of 894.2878276166255 indicates that, on average, suggesting room for improvement in the model's predictive accuracy.

### Bi-directional LSTM Model with Sentiment Analysis, MACD Indicator & Hyperparameter Tuning

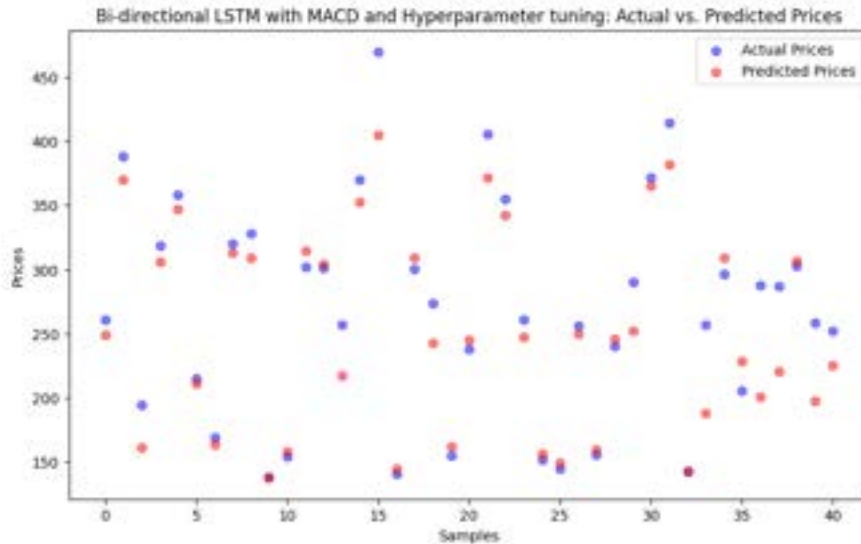

Figure 8: Bi-directional LSTM Model with Sentiment Analysis, MACD Indicator & Hyperparameter Tuning. For the bi-directional LSTM with MACD and hyperparameter tuning, the MSE is 0.014228450035964088. This low MSE indicates that the model predictions are very close to the actual values, suggesting a high level of accuracy and making this model a strong candidate for the final model selection. The chart visually supports this with the predicted values closely matching the actual values.

### Summary

The below table summarizes the different models and their corresponding Mean Squared Error (MSE) metrics mentioned above:

Model	MSE
Linear Regression	8143.439435841439
Multivariable Regression	2.0516316291568004
Random Forest Model	9.181053484740085
Linear Regression with Sentiment Analysis	5214.257518177014
Multivariable Regression with Sentiment Analysis	4.464519821824686



Random Forest with Sentiment Analysis	13.425193631516159
LSTM with Sentiment Analysis	894.2878276166255
Bi-directional LSTM with MACD & Hyperparameter Tuning	0.014228450035964088

**Discussion**

The results of our study highlight how important advanced feature engineering and model complexity are to improving the accuracy of stock predictions. Traditional models like Random Forest and Simple Linear Regression, although foundational, exhibited limitations in capturing the complex dynamics of stock price variations. The introduction of sentiment analysis data marked a notable improvement, underscoring the influence of market sentiment on stock prices.

The result of combining sentiment analysis with the technical signal MACD is the Bidirectional LSTM model, which stands out for having a significantly decreased Mean Squared Error (MSE). In addition to increasing the model's accuracy in predicting stock prices, this integration highlights how important feature engineering is to improve the performance of the model.

**Bidirectional LSTM Model Superiority**

The low MSE of the Bidirectional LSTM model indicates that this model performs substantially better than all other models tested in this study. These exceptional results can be attributed to multiple significant improvements in this approach:

**Integration of MACD**

The Bidirectional LSTM model now includes new elements that capture stock price trends and momentum, allowing for an improved understanding of market movements. These features are supported by the inclusion of the Moving Average Convergence Divergence (MACD) indicator. The MACD is calculated by subtracting the long-term exponential moving average (EMA) from the short-term EMA of the stock's closing prices. Specifically, this is computed by first determining the short-term EMA over a window of 12 day periods and the long-term EMA over 26 day periods. Then we calculate the MACD line as the difference between these two EMAs. Additionally, a signal line, which is the EMA of the MACD over a 9 day period window, is computed to trigger buy or sell signals based on the crossover with the MACD line. These indicators were integrated into our dataset as new features to assist in the analysis and prediction of stock price movements, enriching our model with deeper insights into market trends and momentum.

**Hyperparameter Tuning**

Based on the trials from hyperparameter tuning, a variety of configurations for the Bidirectional LSTM model were evaluated, focusing on the number of units, dropout rates, and learning rates to optimize the model's predictive accuracy. The trials table below showcases the different combinations of these hyperparameters that were tested to minimize the Mean Squared Error (MSE). The best model was selected based on the model's ability to forecast stock prices with the lowest MSE, ensuring a balance between complexity and performance to achieve high prediction accuracy. This tuning process supports the robustness of the final model, which is substantiated by the detailed exploration of hyperparameter space as seen in the attached table.

**Table 1 : Hyerparameter tuning details**

<b>Tra ils</b>	<b>Units</b>	<b>Dropout_ 1</b>	<b>Dropout_ 2</b>	<b>Learning Rate</b>	<b>Mean Squared Error(MSE)</b>
0	480	0.1	0.0	0.000363	0.024921772070229053
1	256	0.1	0.4	0.001715	0.024995621293783188
2	320	0.1	0.1	0.000975	0.024484379217028618
3	64	0.0	0.3	0.002336	0.025350735522806644
4	480	0.2	0.2	0.000675	0.024587414227426052
5	448	0.0	0.1	0.001028	0.024744096212089062
6	352	0.0	0.0	0.000350	0.024627000093460083
7	480	0.1	0.2	0.000136	0.024421404115855694
8	480	0.0	0.4	0.000122	0.025497076101601124
9	448	0.2	0.1	0.003965	0.02481305692344904

**Use of Sentiment Analysis**

Incorporating sentiment analysis allowed the model to factor in the impact of market sentiment on stock prices, adding a layer of predictive power that traditional financial indicators alone cannot provide.

The Bidirectional LSTM model's success underscores the potential of combining deep learning techniques with financial indicators and sentiment analysis to achieve better accuracy in stock price prediction. This approach not only improves predictive performance but also offers insights into the complex dynamics that influence stock market behavior.

## **Practical Implications**

For investors and financial analysts, the Bidirectional LSTM model presents an innovative tool for navigating the stock market's volatility. The model's precise stock price predictions could give investors a strategic advantage, enhancing the potential for better returns and lower risks. However, recognizing the inherent unpredictability of financial markets, influenced by unforeseen global events, economic shifts, and regulatory changes is essential.

Future studies could explore the integration of real-time analysis, larger datasets, and additional economic indicators to further refine the model's predictive capabilities. Such advancements could provide even more robust tools for market analysis, investment strategy development, and risk management.

To summarize, this study demonstrates how integrating machine learning and financial analysis could transform the investing landscape and create new opportunities for data-driven approaches. Although these models show promise, they should only be utilized as a component of a thorough investment strategy that takes regulatory compliance, financial fundamentals, and market analysis into account to successfully traverse the complexity of the stock market.

## **Conclusion**

The investigation of different stock prediction models' predictive accuracy, especially that of the Bidirectional LSTM model, highlights the exciting possibilities of incorporating sentiment analysis and technical indicators into machine learning algorithms. This research has shown that the Bidirectional LSTM model outperforms more conventional and less advanced approaches in terms of forecasting accuracy when this model is backed by MACD and optimal hyperparameter adjustment.

## **Key Findings**

The Bidirectional LSTM model significantly outperformed other models in predicting stock prices, as evidenced by the model's minimal MSE. This success highlights the model's ability to effectively capture and interpret the complex dynamics of the stock market. The integration of MACD as a technical indicator and the incorporation of sentiment analysis from news data provided a more nuanced understanding of market movements, contributing to the model's superior performance.

## **Potential Impact**

The findings of this research serve as a foundation for those in the financial sector looking to apply AI and machine learning for in-depth market analysis. Furthermore, the results contribute to the field of quantitative finance by demonstrating the possibility of boosting forecast accuracy through the integration of financial analytics and machine learning.

### **Suggestions for Future Research:**

Although the Bidirectional LSTM model is a big advancement, this model requires more testing and verification before being used in real-world applications. To confirm the model's efficiency, further research could expand the dataset, investigate more technical indicators, and use the model in various market sectors.

Incorporating global economic indicators and examining the effects of real-time news sentiment analysis may yield more insightful results and improve model performance.

Important issues for future research include addressing the problem of model overfitting and investigating the model's applicability to high-frequency trading data.

The results of this study confirm that incorporating machine learning into financial decision-making procedures is both feasible and more prevalent. The use of these advanced technologies will become more essential as the financial sector develops.

### **Supplement Material - Model Definitions**

#### **Linear Regression Model**

- Definition: A statistical method that models the relationship between a single independent variable and a dependent variable by fitting a linear equation[18].
- Methodology: Used day numbers or Sentiment score as the independent variable to predict stock closing prices. Assumes a linear relationship over time or sentiment score.

#### **Multiple Linear Regression Model**

- Definition: Extends simple linear regression to multiple independent variables to predict a dependent variable, allowing for more complex relationships[19].
- Methodology: Incorporated features are Open, High, Low, Volume, Day with and without the Sentiment Score to predict closing prices.

#### **Random Forest Model**

- Definition: An ensemble learning method that operates by constructing a multitude of decision trees at training time to improve prediction accuracy[20].
- Methodology: Used stock data features (Open, High, Low, Volume, Day, with and without Sentiment Score) for prediction.

#### **LSTM Model**

- Definition: A type of recurrent neural network capable of learning order dependence in sequence prediction problems[21].
- Methodology: Applied to capture long-term dependencies in stock price movements using sequence data.

#### **Bidirectional LSTM Model**

- Definition: An advanced version of the LSTM model, incorporating technical indicators like MACD and optimized through hyperparameter tuning for improved accuracy[22].

- Methodology: Includes MACD for feature richness and hyperparameter tuning for optimal performance.

### **Acknowledgments**

This research paper is based on the AI/ML python project "Predictive Model for Stock Prediction Using ML" done under the mentorship of Sharifa Sahai, Ph.D. Candidate, Harvard University Systems, Synthetic, and Quantitative Biology, from December 2023 to April 2024. I would like to express my sincere gratitude to Sharifa Sahai for her invaluable guidance and support throughout this project.

## Works Cited

- [1] Guo, J., & Tuckfield, B. (2020). News-based Machine Learning and Deep Learning Methods for Stock Prediction. *Journal of Physics: Conference Series*, 1642(1), 012014. <https://doi.org/10.1088/1742-6596/1642/1/012014>
- [2] NewsData.io, existing news sources, headlines, and topics from a database of over 74982 news sources archived in the past 6 years : <https://newsdata.io/>
- [3] Yeung, T. (2023, December 7). The MACD Indicator: Making Technical Analysis Work: Beating the market is surprisingly easy when you combine technical analysis with fundamental data. InvestorPlace. <https://investorplace.com/2023/12/the-macd-indicator-making-technical-analysis-work/>
- [4] Aroussi, R. (2019, April 17). Reliably download historical market data from with Python. PythonYFinance. <https://aroussi.com/post/python-yahoo-finance>
- [5] Kozyrkov, C. (2022, July 8). How to Use the MSE in Data Science: Mean squared error (MSE) for performance evaluation and optimization. Medium. <https://kozyrkov.medium.com/how-to-use-the-mse-in-data-science-bd350154a9d>
- [6] Hochreiter, S., & Schmidhuber, J. (1997). Long Short-Term Memory. *Neural Computation*, 9(8), 1735-1780. <https://direct.mit.edu/neco/article-abstract/9/8/1735/6109/Long-Short-Term-Memory?redirectedFrom=fulltext>
- [7] Patel, J., Shah, S., Thakkar, P., & Kotecha, K. (2015). Predicting stock and stock price index movement using Trend Deterministic Data Preparation and machine learning techniques. *Expert Systems with Applications*, 42(1), 259-268. <https://doi.org/10.1016/j.eswa.2014.10.031>
- [8] Bollen, J., Mao, H., & Zeng, X. (2011). Twitter mood predicts the stock market. *Journal of Computational Science*, 2(1), 1-8. <https://www.sciencedirect.com/science/article/abs/pii/S187775031100007X?via%3Dihub>
- [9] Corizzo, R., Rosen, J. Stock market prediction with time series data and news headlines: a stacking ensemble approach. *J Intell Inf Syst* (2023). <https://doi.org/10.1007/s10844-023-00804-1>
- [10] Yeung, T. (2023, December 7). The MACD Indicator: Making Technical Analysis Work: Beating the market is surprisingly easy when you combine technical analysis with fundamental data. InvestorPlace. <https://investorplace.com/2023/12/the-macd-indicator-making-technical-analysis-work/>
- [11] Tsantekidis, A., Passalis, N., Tefas, A., Kannianen, J., Gabbouj, M., & Iosifidis, A. (2017). Forecasting stock prices from the limit order book using convolutional neural networks. In *Proceedings of the IEEE Conference on Business Informatics (CBI)*. <https://ieeexplore.ieee.org/document/8010701/>
- [12] GeeksforGeeks. (n.d.). Get Financial Data from Yahoo Finance with Python. Retrieved from <https://www.geeksforgeeks.org/get-financial-data-from-yahoo-finance-with-python/>
- [13] NewsData.io. Historical News API, Existing news, Headlines, Topics, or Keywords from

- the database of 74982 News sources archived in the past 6 years from 206 Countries  
<https://newsdata.io/historical-news-api>
- [14] Aroussi, R. (2019, April 17). Reliably download historical market data from with Python. PythonYFinance. <https://aroussi.com/post/python-yahoo-finance>
- [15] "New Archive Endpoint," NewsData.io. <https://newsdata.io/documentation/#news-archive>
- [16] Roberts, C. (2023, April 25). Stock price Prediction using LSTM & Technical Indicators. Medium.  
<https://medium.com/@mrconnor/stock-price-prediction-using-lstm-technical-indicators-95ae61ae7a7a>
- [17] Roberts, C. (2023, April 25). Stock price Prediction using LSTM & Technical Indicators. Medium.  
<https://medium.com/@mrconnor/stock-price-prediction-using-lstm-technical-indicators-95ae61ae7a7a>
- [18] GeeksforGeeks. (n.d.). Linear Regression in Machine learning. Retrieved from [https://www.geeksforgeeks.org/ml-linear-regression/?ref=header\\_search](https://www.geeksforgeeks.org/ml-linear-regression/?ref=header_search)
- [19] GeeksforGeeks. (n.d.). Linear Regression in Machine learning - |Multiple Linear Regression. Retrieved from [https://www.geeksforgeeks.org/ml-linear-regression/?ref=header\\_search](https://www.geeksforgeeks.org/ml-linear-regression/?ref=header_search)
- [20] Analytics Vidhya. (2021, June). Understanding Random Forest. Retrieved from <https://www.analyticsvidhya.com/blog/2021/06/understanding-random-forest/>
- [21] GeeksforGeeks. (n.d.). Deep Learning | Introduction to Long Short Term Memory. Retrieved from <https://www.geeksforgeeks.org/deep-learning-introduction-to-long-short-term-memory/>
- [22] RoboForex Blog. (2023, April 7). How to Trade the Three Moving Averages MACD Strategy. Retrieved from <https://blog.roboforex.com/blog/2023/04/07/how-to-trade-the-three-moving-averages-macd-strategy/>

## **Diet Habits Among High Schoolers in New York City Public High Schools Correlation With Academic Performance By Ayan Najam**

### **Abstract**

Numerous studies have claimed a connection exists between the diet habits of students and their academic success in school. However, little is known about this correlation between NYC high school students' diet habits and their academic performance. This research paper aims to fill this gap in knowledge by analyzing this correlation with NYC high school students where there proves to be a desperate need for more research because of unhealthy diet habit practices. The hypothesis for this study was there would be a positive correlation between the diet habits of high school students and their academic performance. This research paper will follow a mixed-methods procedure, utilizing quantitative and qualitative data. Quantitative data will be obtained through the frequency of meals consumed in four weeks by the participant through the 24-hour Dietary Recall and running a linear regression through the grades to find a correlation. Qualitative data will be collected by conducting a thematic analysis of the participant's responses to analyze a shift in the participant's attitudes about their eating habits to their academic performance. Through these methods, the results achieved in this research pertained to finding a weak correlation between the consumption of breakfast and lunch and a NYC high school student's academic performance, while the consumption of dinner received a moderate correlation. With limitations ranging from small sample sizes to not collecting participants from two of the five boroughs in NYC, the conclusion proved that there is a weak correlation between these two variables.

### **Introduction**

There's no question that food's fundamental role in life is to provide individuals with energy for survival. Indeed, food is the main source that gives individuals the necessary nutrients they need to survive. However, even though food is essential for one's health, the type of foods consumed is even more notable to ensure their well-being. Over time, individuals' consumption of these foods eventually turns into their diet habits, an individual's food preferences. These diet habits can vary from strict diets, i.e. Mediterranean diet, to individuals' everyday eating patterns. Henceforth, to optimize one's energy and health, one's diet habits must be in check.

Considering this linkage between diet and health, if one was considering a high school student, one would assume their diet habits to be balanced to provide them with the necessary nutrients for their growth. However, besides these nutrients that high school students need, the impact between their diet habits and their academic performance must also be assessed. Referring to how diet affects one's overall health, the idea of diet also being responsible for the learning ability of a child can be extrapolated. Sure enough, current research conducted between these two variables supports a potential connection. Although research done in larger areas gives an excellent overview of exemplifying this correlation in larger populations, further research is necessary in smaller areas, i.e. cities. It is vital to examine specific cities containing students with



detriments in their diet habits as the findings can give a more comprehensive understanding of this connection. Among these cities, New York City (NYC) comes to mind because of how high schoolers are currently being affected by unhealthy diet habits. As stated by the NYC Food Report, 40% of NYC high school students are undergoing some form of obesity, depicting a lack of nutrition in their diet habits<sup>81</sup>. This startling statistic expresses the urgency for more research in NYC to grasp whether or not high schoolers' nonnutritious diet habits are linked to their academic performance.

Thus, this research paper aims to find the correlation between the diet habits of NYC high school students and their academic performance. The methods utilized in this research will revolve around correlational analysis through administering questionnaires/forms for the participants to complete, as well as a thematic analysis. Upon completion of this research, more information about this topic will be revealed, uncovering whether or not academic performance is impacted by NYC high schoolers' diet habits. The leading research question to guide this paper is: To what extent do diet habits among high school students in NYC Public High Schools correlate with academic performance?

## **Literature Review**

### **K-8, High School, and College Students in Foreign Countries**

To better understand the context of this topic, a review of the current research in foreign countries is needed. Examining studies conducted in foreign countries and comparing the findings found in America helps draw similarities/differences between various populations. Even more so, acknowledging students from different age groups is vital to recognizing any common themes.

When examining elementary students, Florence et al., researchers with Ph. D.s in Epidemiology and Biostatistics, provide excellent insight by examining 5,200 Grade 5 students in specific areas in Nova Scotia, Canada, and finding a strong, positive correlation between the diet habits of these students and their academic performance<sup>82</sup>. The usage of a Food Frequency Questionnaire (24-hour Dietary Recall), a form that allows participants to log what they've eaten in the past day, further strengthens the results of this paper by utilizing a satisfactory tool to gauge the diet habits of Grade 5 students within a specific period. Despite this, this correlation is simply a glimpse of how diet habits can impact academic performance in elementary students. Thus, more research with older students must be examined to understand the complexity of this issue even further.

When considering middle school students, researchers Muhammed Shabir et al. found a significant positive correlation between the consumption of low-nutrition foods and decreased

---

<sup>81</sup> New York City Government. (2023, June 8). PRIORITIZING FOOD EDUCATION IN OUR PUBLIC SCHOOLS: A path to developing a healthy next generation. *NYC.gov*.

<sup>82</sup> Florence, M. D., Asbridge, M., & Veugelers, P. J. (2008). Diet Quality and Academic Performance. *Journal of School Health, 78*(4), 209–215. <https://doi.org/10.1111/j.1746-1561.2008.00288.x>

academic performance in Pakistani middle schoolers through a 24-hour Dietary Recall<sup>83</sup>. Results also included a linkage between the lack of physical activity to decreased academic performance, however, the connection between the middle schoolers' diet habits and academic performance remained pertinent. Much similar to the results discovered by Florence et al., Muhammed Shabir et al.'s results reinforce how diet habits are directly connected to one's academic performance. Therefore, the correlations found by Florence et al. and Muhammed Shabir et al. show strong similarities in how diet habits can impact elementary and middle school students' academic success.

When examining high schoolers, researchers Alqahtani et al. concluded that there's a positive correlation between high schoolers' breakfast habits in Aseer, Saudi Arabia, and their academic performance<sup>84</sup>. Although this finding focuses more on breakfast habits compared to the holistic diet of a student, it is worth noting how there is still a positive correlation between the two variables. This introduces the idea of specific meals correlating with one's academic prowess instead of one's holistic diet as found by Florence et al. and Muhammed Shabir et al. Despite this, the correlation of a high schooler's entire diet to their academic performance is overlooked and thus, reveals a key caveat to this study. A study exemplifying the correlation between their diet and academic performance must be conducted to provide a more thorough insight into high schoolers.

When considering college students, researchers Uwannah et al. deduced a positive correlation between the diet habits of college students in Ikenne, Ogun State, and their academic performance<sup>85</sup>. Although this study does consider the holistic diet of a college student, the study specifically hones in on breakfast by monitoring the frequency of breakfast consumption, similar to Alqahtani et al.'s study. Conversely, through the usage of a Food Frequency Questionnaire, the results corroborate the idea of a positive correlation between the diet habits of college students and their academic performance.

Upon analyzing these studies, the presence of a positive correlation between the diet habits of students and their academic performance is common. When examining the tool utilized to gauge a participant's diet habits, a 24-hour Dietary Recall seemed to be the most popular tool, gathering data related to the frequency of specific meals consumed. Furthermore, quantitative data proved to be commonly collected throughout these studies using logistic regressions, however, not much focus was on the qualitative data, illustrating a weakness in the intricacy of the findings. In the end, most studies concluded a positive correlation between a student's diet habits and their academic performance, despite the correlation between high schoolers remaining in a blur due to there being no research on the entirety of one's diet and their academic success.

---

<sup>83</sup> Muhammad Shabbir, Qamar-uz-Zaman, & Muhammad Atif. (2019). Effects of Malnutrition on the Academic Performance: A Case Study of Grade 6-8 Learners in Punjab, Pakistan. *Review of Economics and Development Studies*, 5(4). <https://doi.org/10.26710/reads.v5i4.882>

<sup>84</sup> Alqahtani, Y., Assiri, OhoodA. A., Al-Shahrani, NoufS. S., Alyazidi, NohaS. S., & Alshahrani, MalakS. H. (2020). Relationship between nutritional habits and school performance among primary school students in Asser Region. *Journal of Family Medicine and Primary Care*, 9(4), 1986. [https://doi.org/10.4103/jfmpc.jfmpc\\_885\\_19](https://doi.org/10.4103/jfmpc.jfmpc_885_19)

<sup>85</sup> Uwannah, N., Caroline, A., & Lotachi. (2018). *Eating Habit and Academic Performance of Secondary School Students in Ikenne, Ogun State*.

## **K-8, High School, and College Students in America**

Now, having explored studies conducted in foreign countries, discerning studies from America is just as crucial to understanding the overall issue. As previously mentioned, dissecting studies from America will allow for comparisons between the findings from foreign studies to find common themes and results.

When considering elementary students in America, researchers Molinelli et al. claim that a positive correlation between the nutrition of students and their academic performance<sup>86</sup> exists. It's worth noting how despite this study taking place in America, the results are highly similar to the results Florence et al. found in their paper, illustrating a positive correlation between the diet habits of elementary students and their academic performance through the usage of 24-hour Dietary Recalls. This positive correlation, and the tool employed, is a common theme in both research papers and it is crucial to understand this similarity to better understand this topic.

When considering middle school students, researchers Kleinman et al. found a positive correlation between the diet habits of middle schoolers and their academic performance<sup>87</sup>. The findings of this paper closely resemble those of Muhammed Shabir et al. and how both papers used 24-hour Dietary Recalls to analyze diet habits to show a linkage between the diet habits of a middle schooler and their academic performance. Moreover, Kleinman et al. also stress how a sufficient amount of time must be given to the participant to ensure an accurate depiction of a participant's diet habits of at least two weeks to a month. As a result, one can conclude that a correlation between a middle schooler's diet habit and their academic performance exists, despite the location of the study.

When considering high schoolers, Charles E. Basch, a Ph.D. in Health Education, explains that there's a positive correlation between high schoolers' diet habits and their academic performance and that skipping breakfast can result in negative academic performance<sup>88</sup>. Similar to Alqahtani et al.'s paper, Basch's paper puts forth an analogous conclusion, claiming that breakfast and a high school student's entire diet are vital to their academic performance. This finding provides the necessary clarity about whether or not the entirety of a high schooler's diet habit impacts their academic performance, a piece of information missing from Alqahtani et al.'s study. This is a recurring theme between these two papers and supports a correlation between high schoolers' diet habits and their academic performance.

When looking at college students, Burrows et al. claim that there's a positive correlation between the diet habits of college students and their academic achievement through the usage of a Food Frequency Questionnaire<sup>89</sup>. This paper's findings resemble the findings of Uwannah et al.

---

<sup>86</sup> Molinelli, C. (2022). *The Relationship Between Nutrition and the Success of Learning in American Elementary- Aged Students Nutrition's Impact on Students' Learning*. <https://digitalcommons.sacredheart.edu/cgi/viewcontent.cgi?article=2004&context=acadfest>

<sup>87</sup> Kleinman, R. E., Hall, S., Green, H., Korzec-Ramirez, D., Patton, K., Pagano, M. E., & Murphy, J. M. (2002). Diet, Breakfast, and Academic Performance in Children. *Annals of Nutrition and Metabolism*, 46(1), 24–30. <https://doi.org/10.1159/000066399>

<sup>88</sup> Basch, C. E. (2011). Breakfast and the Achievement Gap Among Urban Minority Youth. *Journal of School Health*, 81(10), 635–640. <https://doi.org/10.1111/j.1746-1561.2011.00638.x>

<sup>89</sup> Burrows, T. L., Whatnall, M. C., Patterson, A. J., & Hutchesson, M. J. (2017). Associations between Dietary Intake and Academic Achievement in College Students: A Systematic Review. *Healthcare*, 5(4), 60. <https://doi.org/10.3390/healthcare5040060>

and how college students' academic performance depends on their diet habits. This again, emphasizes the positive correlation between the diet of a college student and their academic performance.

Upon considering these studies, each study bolsters the conclusion that a strong, positive correlation between a student's diet habits and their academic performance exists. Although these papers were conducted in America, the findings of these papers are akin to the findings found in foreign countries. Moreover, a 24-hour Dietary Recall seemed to be the universal tool to collect a participant's diet habits, regardless of the location of the study symbolizing how successful the tool is in producing valid, reproducible results. Similar to studies done in foreign countries, quantitative data still proved to be the most commonly collected throughout these studies through the usage of logistic regressions, with little importance given to qualitative data. Thus, one can conclude that despite examining a correlation in a foreign country or America, one can expect to find a positive correlation between diet habits and academic performance through the usage of a 24-hour Dietary Recall.

### **Gap and Hypothesis**

When examining the plethora of research conducted on this topic, one specific theme repeatedly presents itself: a positive correlation between diet habits and academic performance of elementary, middle, high school, and college students despite the location of the study. However, when analyzing these studies, little to no studies explored the correlation in smaller regions besides Uwannah et al.'s study in Ikenne, Ogun State. Thus, studying cities where high school students are showing deleterious health effects from their diet habits is essential to capture the bigger picture. When considering these cities, NYC is a notable city that comes to mind. Referring back to how 40% of NYC high school students are currently undergoing some sort of obesity, the connection between whether or not their diet habits impact their academic performance remains unknown<sup>90</sup>. Finding a correlation between these two variables will spur more attention to this issue and lead to solutions for this dilemma. Thus, researching this gap is paramount in capturing the overall perspective and adding a more refined understanding of the topic. Studies focusing on smaller regions will give the field a more comprehensive understanding, further showing the potential correlation between diet habits and a high school student's academic performance. To conduct this research, correlational analysis will be conducted and questionnaires/24-hour Dietary Recalls will be administered. Additionally, academic grades will be collected to find a correlation between high schoolers' diet habits and their academic performance. For a more qualitative understanding, a thematic analysis will be conducted, utilizing open-ended responses relating to the participant's view of the impact of their diet habits on their academic performance before and after the research to uncover any shifts in the participants' attitudes. All of this considered, the hypothesis for this research is that a positive

---

<sup>90</sup> See Footnote 2

correlation between the diet habits of high school students and their academic performance will exist, corroborated by prior research conducted in the field.

## **Methodology**

When studying the correlation between NYC high school students' diet habits and their academic performance, a methodology that can effectively find the connection between these two variables is required. Upon examining prior studies on this subject, it can be deciphered that many of these papers mainly used quantitative methods to find a connection. Although quantitative methods prove to be an effective approach to finding this correlation, past studies neglect the full in-depth understanding by not utilizing qualitative methods. Therefore, qualitative along with quantitative methods must be applied to give the topic a more nuanced understanding. Thus, a mixed-methods procedure will be implemented to achieve a higher level of insight. In terms of sampling, convenience sampling will be the sampling choice for this research study as it will reach more NYC high school students in a greater amount of time. Due to the vast population size of NYC high school students approximately 400,000 students, convenience sampling ensures that students picked are readily available for the research study.

In terms of quantitative analysis, a longitudinal correlational study was conducted with participants logging what they ate in four weeks from the first week of February to the first week of March. Each participant was sent a 24-hour Dietary Recall form via Google Docs and each document was assigned a randomized number to ensure confidentiality about which document that participant owns. The frequency of meals participants consumed throughout the day, as well as their fall semester grades, were collected. From there, a linear regression between the data was calculated to find the correlation between these two variables. Through the usage of linear regression, the relationship between the frequency of meals consumed and academic performance was readily found and results were clearly illustrated through a scatter plot. Values such as a correlation coefficient and a P-value were also calculated to illustrate the strength of the correlation.

On the other hand, qualitative analysis will center around a thematic analysis of the participant's responses to the open-ended questions regarding their perspective on the impact of their diet on their academic performance. The thematic analysis will involve analyzing overarching themes that present themselves and differentiating them. Furthermore, the sets of questions will serve as perspectives before and after the four weeks to allow for comparisons between the participants' mindsets. Responses will be organized based on participants' perceptions of the impact of their diet habits on their academics and how they changed over the research period.

### **24-hour Dietary Recall**

When looking at the prior research studies conducted on the correlation between a student's diet habit and their academic performance, a 24-hour Dietary Recall was the most popular tool used to gauge a participant's diet habit. For instance, researchers such as Alqahtani

et al.<sup>91</sup> and Kleinman et al.<sup>92</sup> both utilized 24-hour Dietary Recalls and deemed it as the most effective tool to gauge a participant's diet by measuring the frequency of meals consumed. However, for the 24-hour Dietary Recall to be effective in gauging a participant's diet habits, it must be administered for a duration of time (around two weeks to a month) that allows for a deep analysis of the participant's diet as claimed by Kleinman et al.<sup>93</sup>. As a result, a timespan of at least a month was utilized for this research, aiming to maximize the possibility of acquiring one's diet habit. For calculating the relationship between a student's diet habit and academic performance, logistic and linear regression were found to be two of the most effective ways to calculate a relationship between these variables as claimed by researchers López-Gil et al.<sup>94</sup> and Florence et al.<sup>95</sup>. To better display the data as well as any patterns the data might reveal over a month, linear regression was chosen as the tool used to be able to find this relationship between the variables. Thus, linear regression and the usage of scatterplots will be used for this research to readily calculate the strength of the correlation between diet habits in students and their academic performance.

To acquire participants, a Google Form via multiple social media platforms, i.e. Instagram, Reddit, and Quora, and an educational portal, Jupiter Ed., were sent to collect participants interested in participating in this research and have the participants complete confidentiality statements (See Appendix A). From there, a pre-made 24-hour Dietary Recall, via Google Docs, was sent to the participants. The title of their 24-hour Dietary Recall would be "Participant #" with the number being randomized to maintain confidentiality between the researcher and participants. Participants were asked to log what they ate for two nonconsecutive days of the week, for four weeks, to have day-to-day variation within the participants' diets (See Appendix B). The reason for having participants log what they've eaten for two nonconsecutive days is to have a greater chance of variance in the diet habits of participants. Consecutive days would introduce the risk of participants eating what they ate the previous day (i.e. leftovers) and thus, no variation in their eating habits<sup>96</sup>. Variation would allow for a thorough analysis of the participant's diet with the expectation of the participant eating different foods each day.

Once the four-week period ended, the 24-hour Dietary Recalls were analyzed to spot frequencies of specific meals that participants had eaten throughout the week. To do this, the frequencies of the different meals consumed (breakfast, lunch, dinner) were counted each week to observe if the participant skipped or ate during those meals. Furthermore, academic grades were correlated with the frequency of meals eaten by participants. Once this data was collected, the data was inserted into Google Sheets and run through linear regression to find a correlation

---

<sup>91</sup> See Footnote 4

<sup>92</sup> See Footnote 8

<sup>93</sup> See Footnote 8

<sup>94</sup> López-Gil, J. F., Mesas, A. E., Álvarez-Bueno, C., Pascual-Morena, C., Saz-Lara, A., & Cavero-Redondo, I. (2022). Association Between Eating Habits and Perceived School Performance: A Cross-Sectional Study Among 46,455 Adolescents From 42 Countries. *Frontiers in Nutrition*, 9. <https://doi.org/10.3389/fnut.2022.797415>

<sup>95</sup> See Footnote 2

<sup>96</sup> National Cancer Institute. (2019). *24-hour Dietary Recall (24HR) At a Glance | Dietary Assessment Primer*. Cancer.gov. <https://dietassessmentprimer.cancer.gov/profiles/recall>

between the two data sets. A scatterplot was constructed to visually show the correlation between the two variables as well as the strength of the correlation. A correlation coefficient was also calculated to determine the strength of the correlation, and a P-value, to further show the influence between these two variables. With this linear regression, the correlation between diet habits in NYC high schoolers and their academic performance was displayed, presenting numerical data that supports a correlation between these two variables. Values such as a correlation coefficient and a P-value were vital values to further show the strength of the correlation, and help compliment the scatterplot in displaying this correlation.

### **Thematic Analysis**

Although past research papers utilized quantitative data to provide numerical data to support a correlation, qualitative data was an overlooked aspect of this correlation. Referring back to Alqahtani et al. and Kleinman et al.'s research, just a few of the many research papers that overlook this facet, these research papers solely focused on the numerical values of the strength of the correlation between high schooler's diet habits and their academic performance. Correlation coefficients and P-values were values that these research papers heavily relied on to strengthen the notion of a correlation between these two variables. Thus, as a way to get the most comprehensive understanding of this topic, qualitative data will be used to display the connection in addition to numerical values.

As a surefire way to measure qualitative data, participants' attitudes to whether or not they think their diet habits influence their academic performance before and after the four weeks were compared. The purpose of this thematic analysis would be to observe any underlying themes of how participants personally feel about their diet habits impacting their academic performance. To conduct this, participants were asked a series of questions in the Google Form about their current view of how much their diet habits impact their academic performance (See Appendix C). These questions asked the participants to reflect on their diet habits and to evaluate whether or not they considered their diet to influence their academic performance. At the end of the four-week research period, the participants were asked the same questions from before the research period to observe any changes in the responses (See Appendix D). These questions centered around whether participants think their diet habits played a role in their academic performance even after participating in this four-week-long research study. From there, a thematic analysis was conducted, analyzing themes that were present within the responses. Specific codes were created ranging from a sentence to a few sentences that encompassed any thoughts that participants had about their perspective toward their diet habits.

By analyzing these specific themes to illustrate the comparisons between the participants' responses, more insight was presented about whether participants thought their diet habits impacted their academic performance or if it was simply not a significant factor in their academic performance.

### **Findings**

## Linear Regression Models

Extracting quantitative data required the construction of linear regression models between the frequency of meals consumed by participants and participants' fall semester grades. Furthermore, values such as a correlation coefficient and P-values were calculated to demonstrate the accuracy and strength of the correlation, along with scatter plots to represent the relationship in a visual light. The horizontal axis (x-axis) of these scatter plots represents the frequency of meals that participants consumed, while the vertical axis (y-axis) represents the grades that all 46 participants received during the fall semester of the 2023-2024 School Year. The maximum y-value the graphs have is the highest average that one of the 46 participants received, while the maximum x-value is 8 because of how for each of the four weeks, participants were to log what they had eaten for only two nonconsecutive days of the week from the 24-hour Dietary Recall. Lastly, these scatter plots also generated a  $y = mx + b$  equation and a  $R^2$  value better to represent the strength of the correlation between these variables.

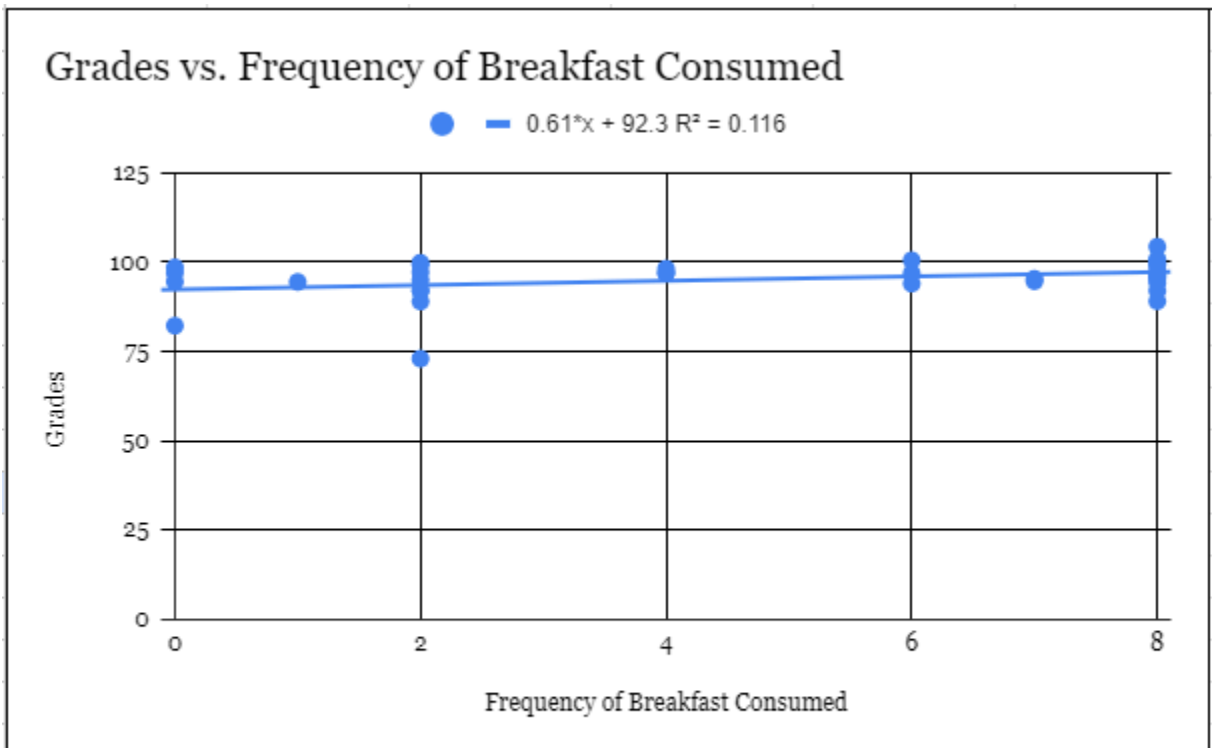

Figure 1.1



Regression Statistics (Breakfast)	
Multiple R	0.3406810409
R Square	0.1160635716
	<i>P-value</i>
Intercept	0
X Variable 1	0.04203006063

Figure 1.2

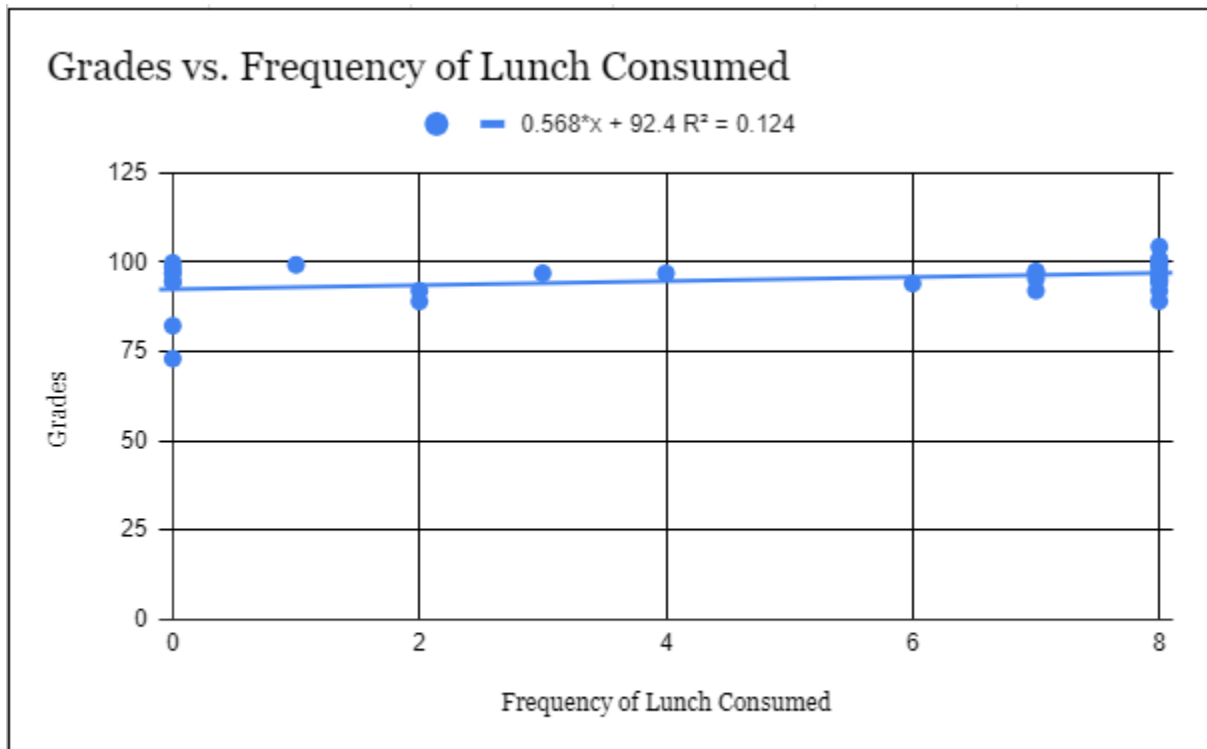

Figure 2.1

Regression Statistics (Lunch)	
Multiple R	0.3519762408
R Square	0.1238872741
	<i>P-value</i>
Intercept	0
X Variable 1	0.03527221297

Figure 2.2

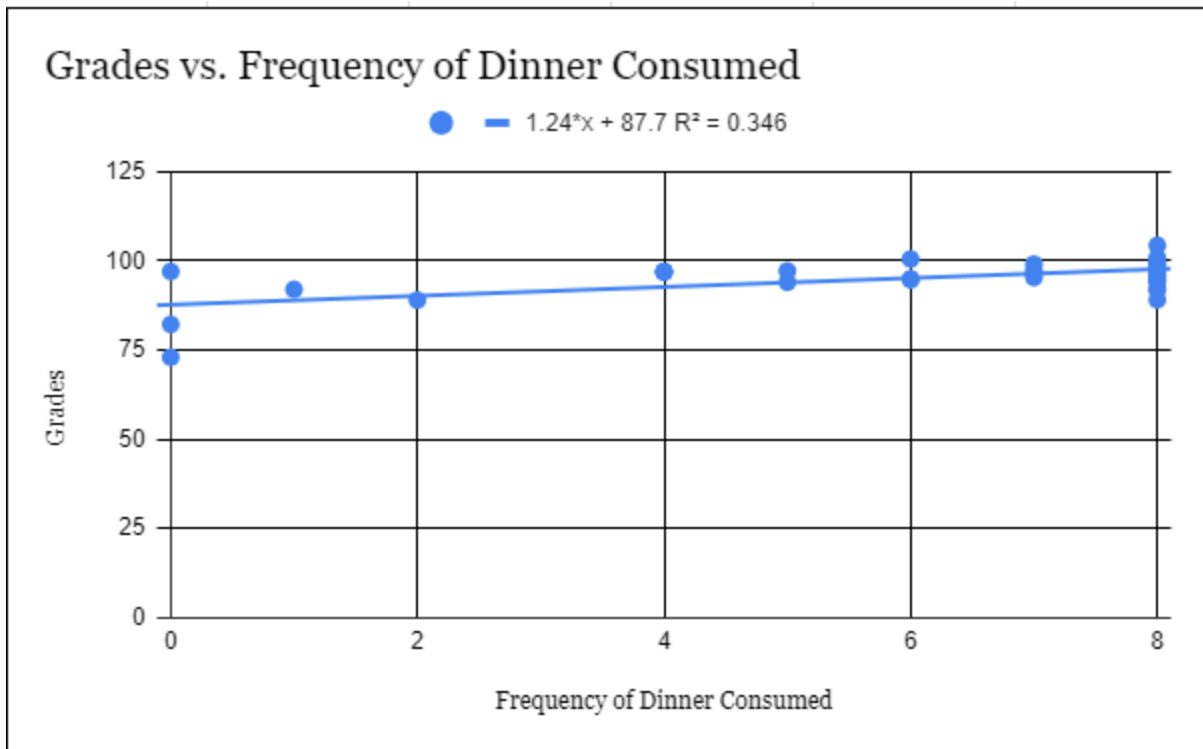

Figure 3.1

<i>Regression Statistics (Dinner)</i>	
Multiple R	0.5886307594
R Square	0.3464861709
<i>P-value</i>	
Intercept	0
X Variable 1	0.000159235907

Figure 3.2

When examining these correlations, it's clear that there's a weak correlation between the frequency of consuming breakfast and lunch to academic performance supported by the multiple R-value (correlation coefficient) being  $<0.5$  as shown in Figures 1.2 and 2.2. When considering the P-value (the probability of no correlation) being  $<0.5$  in Figures 1.2 and 2.2, this signifies the null hypothesis being rejected. Thus, the null hypothesis of the consumption of breakfast and lunch **not** correlating with a high schooler's academic performance is rejected and is statistically significant.

On the other hand, Figure 3.2 supports the fact that there is a moderate relationship between the frequency of consuming dinner and academic performance supported by the correlation coefficient being  $\sim 0.59$ . Moreover, the P-value being significantly  $< 0.5$  in Figure 3.2 reinforces the null hypothesis of the frequency of consuming dinner **not** correlating with a high schooler's academic performance being rejected.

Likewise, just as the correlation coefficient and P-value are crucial to examining the strength of this relationship, the  $R^2$  value is just as vital. The  $R^2$  value is a strong indicator of how well the frequency of meals consumed influences the grades that a high school student achieves. When examining the  $R^2$  value of all three scatter plots, Figures 1.1, 2.1, and 3.1 all show  $R^2$  values of  $< 0.5$  indicating that the fit of all three models is either weak influence or moderate influence. More specifically, the correlation between the frequency of consuming breakfast and lunch and one's academic performance exhibited a weak influence, whereas the frequency of consuming dinner and one's academic performance presented a moderate influence.

### **Thematic Analysis**

To extract qualitative data, participants' responses before and after the four-week research period were interpreted to dissect any shifts in the participants' thinking of how they think their diet habits impacted their academic performance. Participants' responses went through a process of coding to examine any common themes between the participants' responses.

The first theme deciphered from the participants' responses was the belief that diet habits had a significant impact on their academic performance both before and after the research period. Before the research period, participants expressed positive responses explaining how their diet habits were the reason they achieved their grades in school. When comparing these remarks to after the research period, participants maintained this same attitude, claiming that their diet habits impacting their academic performance was accurate because participants noticed having more energy for their classes and the urge to get their tasks completed.

Contrasting with the first theme, the second theme discerned from the participants' responses was participants believed their diet habits to be of low importance to their academic performance, to be of crucial importance. When examining the responses before the research period, participants described not even considering diet habits to be a factor in their academic performance. However, when comparing these responses to those after the research period, participants noticed improvements in their academic grades and had more energy to comprehend subject material. Thus, this shift entailed a negative attitude transitioning to a positive attitude towards this correlation.

The last underlying theme obtained was participants believing their diet habits were not connected to their academic performance before and after the research period. When compared to the previous two themes, this theme presents participants perpetuating their diet habits not having an impact on their academic performance whatsoever. Thus, this shift in the participants'

thinking was minimal as participants' attitudes about their diet habits not impacting their academic performance did not alter throughout the research period.

## **Discussion**

When analyzing the data gathered in this study, the data elucidates a crucial perspective on the correlation between a NYC high school student's diet habits and academic performance. When considering both quantitative and qualitative data, the data points to the notion of there being a weak correlation between the diet habits of an NYC high school student and their academic performance, despite the participants' responses.

Upon examining the quantitative data, it is evident that there is a weak correlation between NYC high school students' diet habits and their academic performance. Thus, the conclusion can be made that diet habits have very little influence on a NYC high schooler's grades. Despite this conclusion being made from a high schooler's holistic diet habit, verdicts can be reached based on specific meals of the day that correlate with their grades. When considering the weak correlation between the frequency of breakfast and lunch consumed and one's academic performance, one can deduce that the frequency of breakfast and lunch consumption has a weak influence on one's academic performance. However, when considering the moderate correlation between the frequency of dinner consumed and one's academic performance, one can conclude that dinner consumption has a slight influence on one's academic performance.

When comparing these results to other research papers, these results prove to be uncommon. For instance, papers such as Basch and Alqahtani et al. prove a positive correlation between the diet habits of high school students and their academic performance, the polar opposite of the findings of this study. However, when situating the uncommon findings of this research into the current body of knowledge, one can observe that despite this research providing a counterargument for the conclusion of there being a correlation between these two variables, it provides another perspective delving into the specific meals that can impact one's academic performance. Although Alqahtani et al.'s paper did focus on breakfast, this research considers all breakfast, lunch, and dinner for thorough analysis. Furthermore, these findings also urge deeper research, illustrating how researching specific meal consumption of NYC high school students and the impact on their academic performance can expose other unprecedented findings.

When examining the qualitative data, changes in participants' responses were present throughout the research period. Most commonly, participants considering their diet habits to be of minimal to significant importance to their academic performance emerged as a popular theme amongst the three themes mentioned previously. This can best be seen through the response given before the research period from Participant 20, claiming that "I haven't really considered my diet habit to be a factor in my academic performance because I feel as though I consistently would be a procrastinator and struggle in the same things whether I ate 'healthy' or not." Compared to the response that Participant 20 gave after the research period, the participant claimed "[I have considered my diet habits to be of] high importance because on the fourth

week, I decided to eat breakfast and it led me to do better during math, actually understanding the subject...” Although participants claim to see an improvement in their academic performance while maintaining healthy diet habits, the quantitative data says otherwise, claiming that there is a weak correlation between the two variables. Nonetheless, the qualitative data proves to be intriguing to the topic, showing how despite concrete numerical evidence that depicts a weak correlation between one’s diet habit and academic performance, high schoolers feel as if their diet habits do play a role in their academic performance. Despite there being only a few participants who maintained the same notion of diet habits playing a role or no role in their academic performance before and after the research, many participants were seen changing their stance arguing that their diet habits were a crucial factor in their academic performance, a conclusion that the quantitative results did not provide.

Regardless, these results still suggest a loose correlation between the diet habits of a NYC high schooler and their academic performance. Although these results don’t align with the positive correlation that Basch and Alqahtani et al. present with high school students, these results still provide an alternative perspective on this topic by exemplifying a correlation between specific meals and a high schooler’s academic performance. A possibility for these results not finding common ground with other studies could be due to the limitations that this research entails. A major limitation is the small sample size of 46 participants as it was not representative of NYC. Moreover, another limitation is that students from the boroughs of Brooklyn and Staten Island were not collected in this study, making this sample size not representative of the entire NYC high school population. Despite these two limitations, these results are useful as they capture a glimpse of the potential correlation between these two variables for high school students in some parts of NYC. Likewise, these results also display a significant implication, spreading more awareness for this connection and giving parents more cognizance of this correlation to be able to provide their children with high-nutrition foods to benefit their academics. Further research into this field would provide a greater comprehensive understanding of the topic, better equipping high school students with knowledge of what influences their academic performance.

## **Conclusion**

Through this research paper, the following research question, “To what extent do diet habits among high school students in NYC Public High Schools correlate with academic performance?” was answered through correlational analysis and analyzing participants’ attitudes toward their diet habits. The findings in this paper, although unique compared to other research papers, proved to be significant to the topic of a correlation between the diet habits of NYC high school students and their academic performance.

Even though the hypothesis of this study claiming there was a correlation between the diet habits of NYC high school students and their academic performance proved to be incorrect, it is clear that there is a weak correlation between the diet habits of NYC high school students and their academic performance reinforced by the findings found. Instead, it was found that

specific meals had a slight connection to the academic grades that NYC high school students received, thus illustrating a weak to moderate correlation between specific meals of the day and an NYC high school student's academic performance. Upon analyzing the quantitative data, there proved to be a weak correlation between the diet habits of NYC high school students and their academic performance. In comparison to the qualitative data, participants expressed seeing a substantial benefit to their academic grades when eating healthy foods, suggesting participants see a connection between their diet habits to their academic grades, regardless of what the quantitative data asserts.

As discussed previously, the presence of limitations greatly hindered the results found in this research. One of the drawbacks is the small sample size of the research of 46 participants. This study focused on the entirety of the NYC high school population and with the population being around 400,000 students, 46 participants was not sufficient to account for the thousands of students. Moreover, another important limitation to consider was NYC high school students not being collected from Brooklyn or Staten Island. With the absence of these two boroughs, this research doesn't encompass the entirety of NYC and thus, provides another fault in the research. With participants being collected from the remaining boroughs, Queens, Manhattan, and the Bronx, this research encompasses only a few parts of NYC.

Regardless of these limitations, these findings still prove that despite the holistic diet habit of a NYC high school student having a weak correlation to their academic performance, a correlation existing between the consumption of specific meals in a day to academic success demonstrates a facet of this complex topic. Using quantitative and qualitative data, the results pointed to a weak correlation between the diet habits of a NYC high school student and their academic performance. This finding urges further research on this topic, explaining why certain meals of the day correlate with a high school student's academic performance, as opposed to the holistic diet habit. More importantly, conducting studies on smaller cities is needed to give a more comprehensive perspective, honing in on different-sized populations. Overall, as time progresses and more research presents itself, high school students will become better suited with the knowledge they need to increase their academic success in school and beyond through healthy, nutritious diet habits.

## Works Cited

- 24-hour Dietary Recall (24HR) At a Glance | Dietary Assessment Primer*. (n.d.).  
Dietassessmentprimer.cancer.gov. <https://dietassessmentprimer.cancer.gov/profiles/recall>
- Alqahtani, Y., Assiri, Ohood A. A., Al-Shahrani, Nouf S. S., Alyazidi, Noha S. S., & Alshahrani, Malak S. H. (2020). Relationship between nutritional habits and school performance among primary school students in Asser Region. *Journal of Family Medicine and Primary Care*, 9(4), 1986. [https://doi.org/10.4103/jfmpe.jfmpe\\_885\\_19](https://doi.org/10.4103/jfmpe.jfmpe_885_19)
- Basch, C. E. (2011). Breakfast and the Achievement Gap Among Urban Minority Youth. *Journal of School Health*, 81(10), 635–640. <https://doi.org/10.1111/j.1746-1561.2011.00638.x>
- Burrows, T. L., Whatnall, M. C., Patterson, A. J., & Hutchesson, M. J. (2017). Associations between Dietary Intake and Academic Achievement in College Students: A Systematic Review. *Healthcare*, 5(4), 60. <https://doi.org/10.3390/healthcare5040060>
- Florence, M. D., Asbridge, M., & Veugelers, P. J. (2008). Diet Quality and Academic Performance. *Journal of School Health*, 78(4), 209–215. <https://doi.org/10.1111/j.1746-1561.2008.00288.x>
- Kleinman, R. E., Hall, S., Green, H., Korzec-Ramirez, D., Patton, K., Pagano, M. E., & Murphy, J. M. (2002). Diet, Breakfast, and Academic Performance in Children. *Annals of Nutrition and Metabolism*, 46(1), 24–30. <https://doi.org/10.1159/000066399>
- López-Gil, J. F., Mesas, A. E., Álvarez-Bueno, C., Pascual-Morena, C., Saz-Lara, A., & Caverro-Redondo, I. (2022). Association Between Eating Habits and Perceived School Performance: A Cross-Sectional Study Among 46,455 Adolescents From 42 Countries. *Frontiers in Nutrition*, 9(9). <https://doi.org/10.3389/fnut.2022.797415>
- Molinelli, C. (2022). *The Relationship Between Nutrition and the Success of Learning in American Elementary- Aged Students Nutrition's Impact on Students' Learning*. <https://digitalcommons.sacredheart.edu/cgi/viewcontent.cgi?article=2004&context=acadfest>
- Muhammad Shabbir, Qamar-uz-Zaman, & Muhammad Atif. (2019). Effects of Malnutrition on the Academic Performance: A Case Study of Grade 6-8 Learners in Punjab, Pakistan. *Review of Economics and Development Studies*, 5(4). <https://doi.org/10.26710/reads.v5i4.882>
- New York City Government. (2023, June 8). PRIORITIZING FOOD EDUCATION IN OUR PUBLIC SCHOOLS: A path to developing a healthy next generation. *NYC.gov*.
- Uwannah, N., Caroline, A., & Lotachi. (2018). *Eating Habit and Academic Performance of Secondary School Students in Ikenne, Ogun State*.

# **An Epigenetic Insight into Chronic Obstructive Pulmonary Disease: From DNA Methylation Mechanisms to Therapeutic Strategies by Trisha Karthi\***

## **Abstract**

Chronic Obstructive Pulmonary Disease (COPD) represents a complicated respiratory disorder caused by the combination of genetic and environmental factors. Among the epigenetic mechanisms, DNA methylation has been highlighted especially since it plays a pivotal role in expression of the genes relevant to the pathogenesis of COPD. This review seeks to understand the function of DNA methylation in the pathogenesis and progression of COPD, as well as its significance in the biomarker field, environmental factors, and treatment methods. DNA methylation, particularly hypermethylation, target genes that are involved in lung maturation, inflammation, and oxidative stress, contributing to the worsening of COPD. Certain genes, whose methylation status is related to hypermethylation, like the Interleukin-1 Beta (IL1B), among others are responsible for an inflammatory process in COPD lungs. The emerging therapeutic procedures, for example, epigenome editing through CRISPR technology and DNMT inhibitors, are being used for the personalized management of COPD disease. This review seeks to elucidate that employing such approaches together with conventional pharmacological interventions might present a complete treatment plan which could be adjusted to each patient according to their specific molecular characteristics.

Keywords: COPD, Epigenetic, CRISPR, Methylation

## **1. Introduction**

The relationship between genetic predisposition and environmental factors plays a significant role in shaping the intense landscape of human health. Within this, epigenetic mechanisms, particularly DNA methylation, has proved to have a pivotal role in influencing gene expression without altering the original underlying genetic code [1]. Further, environmental factors have been proven to have an effect on pathology to a great extent. For example, chemical pollutants, such as heavy metals and industrial toxins, can contribute to cellular damage and dysfunction, leading to conditions ranging from respiratory illness to neurological disorders [2]. Moreover, biological agents present in the environment, such as pathogens and allergens, can trigger immune responses and bring about infectious diseases or allergic reactions [3][4]. On the other hand, Socioeconomic and lifestyle factors, including access to healthcare, socioeconomic status, diet, and physical activity, also shape disease patterns and outcomes within populations [5]. In the context of respiratory health, unraveling the epigenetic organization of genes in organs such as the lungs and bronchi is necessary for understanding the complexities of physiological processes and the pathogenesis of respiratory diseases [6][7]. Among these, COPD stands out as a multifaceted condition characterized by airflow limitation and persistent respiratory symptoms [6]. Moreover, COPD holds an immense significance within healthcare and society. As the second leading cause of death in the world, the illness affects a wide range of people and accounts for a considerable portion of global disability-adjusted life years (DALYs)



lost [7]. Not only does COPD affect patient health, but it also puts a substantial burden on the healthcare system through healthcare utilization, lost productivity, and premature mortality [8][9]. Furthermore, COPD is often associated with other chronic conditions, which exacerbates the complexity of patient management and places an additional strain on the healthcare system. As a result, this paper delves into the effects of epigenetic modifications on the molecular landscape associated with COPD, with a specific focus on DNA hypermethylation. 2 Overall, this paper aims to investigate the role of DNA methylation and other epigenetic modifications on the development and progression of COPD. Firstly, I will investigate the current understanding of DNA methylation, in relation to its parentage of epigenetic modifications. Next, I will examine what exactly COPD is and its current state within the medical field. After looking at COPD, I will look at the overall effect of many different epigenetic modifications on COPD, before putting a wider lens on DNA hypermethylation. Due to the importance of DNA hypermethylation in the epigenetic mechanism that contributes to COPD, I have put a great focus on this specific modification. DNA hypermethylation is extremely significant because of its connection to regulating numerous cellular processes, including embryonic development, genomic imprinting, X-chromosome inactivation, and tissue-specific gene expression [10]. A disorder of DNA methylation has been implicated in a wide array of diseases, including cancer, neurological disorders, and autoimmune conditions, underscoring its seriousness in health and disease [12]. Furthermore, DNA methylation patterns can be influenced by environmental factors, lifestyle choices, and aging, highlighting its susceptibility to external stimuli which in turn can lead to a variety of illnesses, including COPD [13]. After this, I will investigate current therapeutic solutions given for this issue while also suggesting some new ways to relieve one from this disease. Moreover, this paper also seeks to explore the environmental and lifestyle factors that may influence DNA methylation in the context of COPD. By understanding how factors such as smoking, air pollution, and occupational exposures affect DNA methylation patterns, I aim to show the complex interplay between epigenetic modifications and environmental triggers in COPD development [11]. By understanding these concepts in this review, individuals, healthcare professionals, and society can understand the complexity of COPD. Since COPD represents a significant public health burden globally by contributing to morbidity, mortality, and healthcare costs, it is incredibly important to properly recognize the various causes of the disease [15]. Currently the healthcare system uses a more traditional approach to COPD management which often focuses on symptom relief and disease stabilization however these therapies may not address underlying molecular mechanisms [16][18]. By reviewing the epigenetic modifications associated with COPD, such as histone modifications, non-coding RNA, and especially DNA methylation, researchers can unwind novel insights into disease pathogenesis and identify new targets for intervention [19][20][18]. Moreover, understanding the role of epigenetics in COPD reveals the importance of preventative measures, such as smoking cessation and environmental regulations, in reducing disease risk and progression [20]. Additionally, the implementation of the proposed therapeutic solutions reviewed in this paper holds promise for personalized treatment strategies tailored to individual

patients' molecular profiles, potentially improving outcomes and quality of life for those affected by COPD.

## **2. What is COPD?**

According to the Centers for Disease Control and Prevention (CDC), COPD is the sixth largest cause of death in the United States, showing just how many people the disease affects [23][24]. COPD is marked by an ongoing, irreversible restriction in airflow. A collection of progressive respiratory illnesses defined by persistent airflow limitation are included in the clinical definition of this disease [25]. This restriction is typically linked to long-term lung parenchymal and airway inflammation. As the second leading cause of death worldwide, COPD has a major influence on public health [25][26][27]. The main cause of this illness is extended exposure to irritant gasses or particulate matter, which is most frequently inhaled through cigarette smoke. Besides smoking, COPD also develops because of other variables such as genetic predispositions, occupational exposures, and air pollution. COPD includes two primary forms: emphysema, which is defined by damage to the lung's air sacs that reduces their elasticity, and chronic bronchitis, which is characterized by inflammation and narrowing of the bronchial tubes [26].

The main signs of COPD are chronic cough, increased mucus production, wheezing, and shortness of breath [12]. People frequently have exacerbations as the condition worsens, which are characterized by an abrupt worsening of symptoms and a subsequent loss in lung function [12][13]. In addition to having a significant negative impact on respiratory health, COPD has systemic effects that lead to several comorbidities such as coronary artery disease, heart failure, and hypertension as well as an increased risk of pneumonia and bronchitis due to compromised lung function and impaired immune responses [26].

In the case of COPD, pulmonary function tests are used to identify airflow limitation in patients, and bronchodilator drugs, inhaled corticosteroids, smoking cessation, and pulmonary rehabilitation are commonly used in the treatment of the condition [26]. COPD persists despite continuous attempts to reduce risk factors and improve treatment approaches.

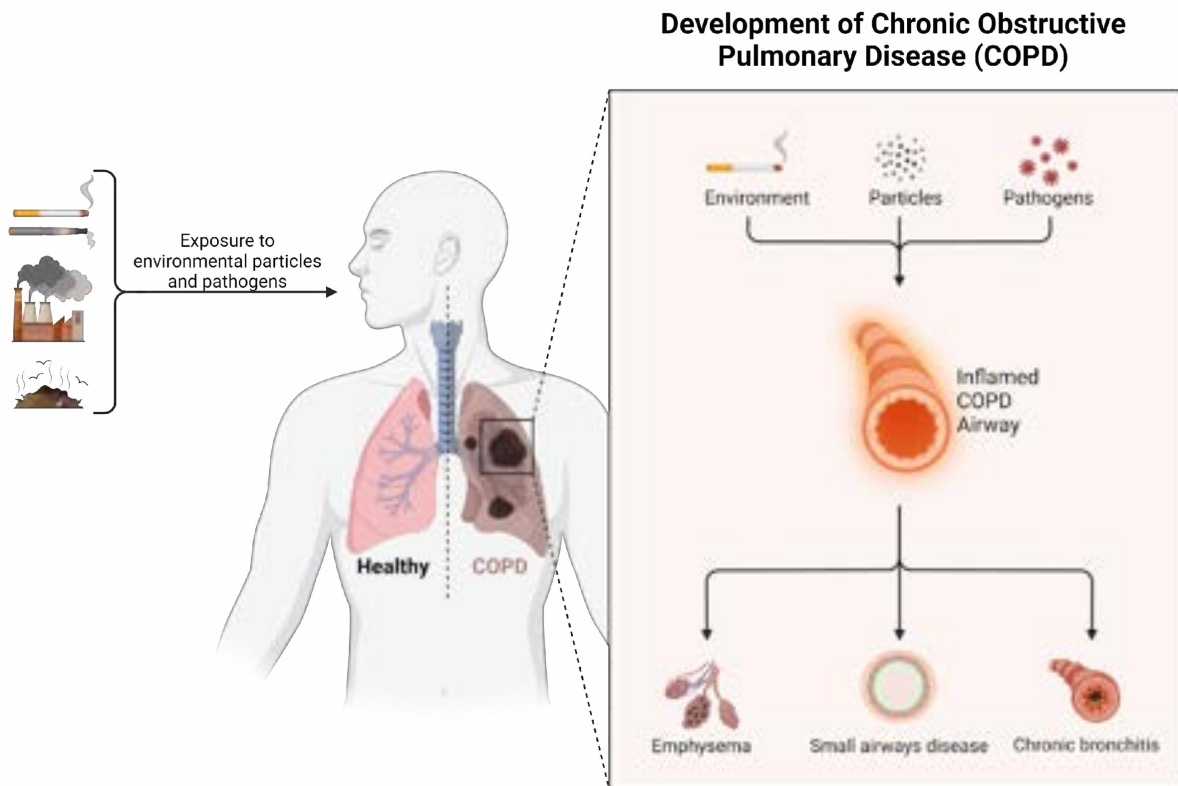

Figure 1: The Development of COPD

COPD is still a major global health concern that requires extensive research and treatments to enhance patient outcomes and quality of life. An extensive evaluation of the patient's clinical symptoms, medical history, and objective assessments of lung function are necessary for the diagnosis of COPD. The assessment of pulmonary function using spirometry, a popular and accurate test that assesses several parameters, including Forced Vital Capacity (FVC), is an essential part of the diagnosis process for COPD. One important diagnostic technique is spirometry, which measures the volume and velocity of air that can be breathed and expelled [28]. Forced Vital Capacity, a crucial metric derived from spirometry, denotes the most amount of air that an individual can compel themselves to expel following a profound breath [29]. Reduced Forced Vital Capacity is a characteristic of airflow limitation in COPD, mostly due to the obstructive component of the disease. The blockage causes the lungs to take longer to empty completely during exhale, which lowers the forced vital capacity [28][29][30]. The ability to differentiate between restrictive and obstructive lung disorders can be achieved with the use of the Forced Vital Capacity measurement. Another important spirometry parameter, forced expiratory volume in one second (FEV1), also decreases in COPD along with a fall in forced vital capacity [28]. It is common practice to utilize the FEV1/FVC ratio to determine whether airflow restriction is present. The defining characteristic of COPD<sup>24</sup> is persistent airflow limitation, which is indicated by a lower FEV1/FVC ratio ( $< 70\%$ ) [29].

In addition to spirometry, other diagnostic methods, including chest X-rays or CT scans, may be used to evaluate lung anatomy and rule out other possible causes of illness [28]. Blood gas analysis can also give information on blood oxygen and carbon dioxide levels, which can be helpful in determining how severe a patient's respiratory impairment is if they have COPD [29].

On the other hand, the immune system plays a critical role in COPD pathogenesis, as it contributes to chronic inflammation, tissue damage, and remodeling within the lungs [27]. In response to inhaled irritants such as cigarette smoke and environmental pollutants, immune cells in the lungs, including macrophages, neutrophils, and T lymphocytes, become activated, releasing pro-inflammatory mediators and creating a state of chronic inflammation [28].

Conversely, one emerging area of research in COPD pathophysiology is the role of cellular senescence. Senescent cells are cells that have entered a state of irreversible growth arrest in response to various stressors, including DNA damage, oxidative stress, and inflammation [29]. While senescent cells serve as a protective mechanism to prevent the proliferation of damaged cells, recent studies *suggest* that senescent cells play a detrimental role in COPD [30]. Senescent cells secrete a complex array of pro-inflammatory cytokines, chemokines, and extracellular matrix-degrading enzymes, collectively known as the senescence-associated secretory phenotype (SASP) [50]. This SASP can cause chronic inflammation, promote tissue fibrosis, and impair tissue repair mechanisms within the lungs, contributing to the pathogenesis of COPD [30][31].

Moving on, studies have shown that many epigenetic modifications have been observed as one of the causes of COPD, and DNA methylation has shown to deviate from normal methyl levels in COPD patients.

### **3. The Intricacies of DNA Methylation**

#### **3.1 Understanding DNA Methylation**

DNA methylation, an important epigenetic modification, involves the addition of methyl groups (-CH<sub>3</sub>) to cytosine residues, particularly in CpG dinucleotides [38]. This modification is done by a family of enzymes known as DNA methyltransferases (DNMTs), with DNMT1, DNMT3a, and DNMT3b being the primary ones and this process usually occurs in regions rich in CpG islands, often located in gene promoter regions [35][36][37]. Methylation at these sites acts as a regulatory switch, influencing gene expression patterns by either promoting transcriptional repression or regulating gene activation [36]. In the context of DNA hypermethylation, which is the excessive addition of methyl groups, the gene promoter regions become densely methylated, leading to a suppressed

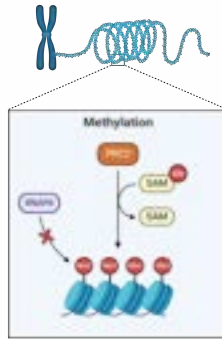

Figure 2: DNA Hypermethylation occurring within the chromosome and the inhibition of mRNA

transcriptional state [40]. This can result in the silencing of crucial genes associated with a multitude of cellular processes. On the other hand, hypomethylation, or the removal of methyl groups, is linked to gene activation, allowing for the expression of specific genes [40][41]. The figure above shows the formation of DNA hypermethylation with the use of PRC2 and SAM. Polycomb Repressive Complex 2 (PRC2) is a multi-protein complex that is found within eukaryotic cells and plays a central role with DNA methylation. The core components of PRC2 include EZH2 (Enhancer of Zest Homolog 2), which is the catalytic subunit responsible for methyltransferase activity, along with other proteins such as EED (Embryonic Ectoderm Development) and SUZ12 (Suppressor of Zeste 12). These proteins work together to recognize specific chromatin regions and regulate the addition of methyl groups to histones. On the other hand, Sadenosylmethionine (SAM) is a key molecule involved in methylation reactions, serving as the primary methyl group donor. In the case of this figure, the amount of methyl groups that SAM is adding to the chromosome is too many, causing RNAPII, which is used for mRNA transcribing, is blocked. Therefore, silencing that gene.

### 3.2 DNA Methylation's role in COPD

Within the respiratory system, the DNA methylation process plays a nuanced role in the regulation of genes crucial for lung development, immune response, and airway maintenance [46] Alterations in this epigenetic landscape, whether through hypermethylation or hypomethylation, can disrupt the delicate equilibrium of gene expression, potentially contributing to the onset and progression of respiratory diseases. Understanding these molecular complexities is essential for unwinding the connection between epigenetic modifications and respiratory health [41][42][43].

Specifically looking at DNA methylation, studies have shown that there are deviant DNA methylation patterns in COPD patients, particularly in genes involved in inflammation, oxidative stress, and tissue remodeling pathways [70]. For example, the DNA hypermethylation of genes associated with antioxidant defenses, such as glutathione Stransferase (GSTP1), can impair their expression, leading to increased oxidative stress and inflammation in the lungs [70][71]. Similarly, hypomethylation of pro-inflammatory genes, such as interleukin-8 (IL-8), may aggravate airway inflammation and mucus production that is characteristic for COPD [72].

Further, environmental variables, such as cigarette smoke and air pollution, can induce DNA methylation changes in susceptible individuals, further creating a risk of COPD [70].

#### 4 Epigenetics and COPD

Genetic alterations can have a substantial effect on the respiratory system and may be involved in the onset of COPD [50]. Genetic predispositions can increase susceptibility to COPD, even if environmental factors like air pollution and tobacco smoke are the main causes of the disease [52][30]. COPD-related genetic alterations frequently affect genes in charge of preserving lung integrity, controlling inflammation, and fending off oxidative stress [41]. Alpha-1 Antitrypsin deficiency, a genetic disorder brought on by mutations in the SERPINA1 gene, is one such example. By blocking the enzymes that degrade lung tissue, the protein Alpha-1 Antitrypsin is essential for preventing lung damage [50].

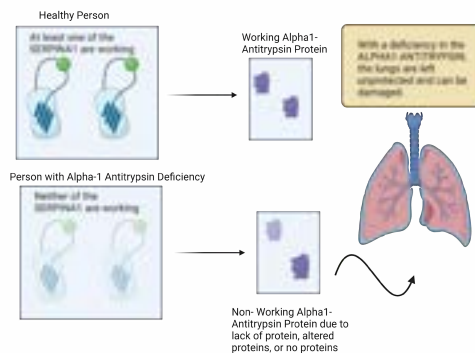

Figure 3: The Effects of Alpha-1 Antitrypsin Deficiency on the Lungs

Alpha-1 Antitrypsin deficiency brought on by mutations in the SERPINA1 gene can result in unchecked enzyme activity, which accelerates the deterioration of lung tissue and raises the risk of COPD, especially in younger individuals [73]. Susceptibility to COPD can also be influenced by genetic differences in other pathways, such as those pertaining to immunological regulation and inflammatory responses [73]. For example, variations in immune system-related genes, such as tumor necrosis factor alpha (TNF-alpha), have been connected to heightened airway inflammation, aggravating the symptoms of COPD [73][74]. Determining who is more at risk and creating individualized treatment plans require an understanding of the genetic foundations of COPD [74]. To manage this complex respiratory disorder, more targeted and effective interventions must be developed. Genetic testing and ongoing research efforts are crucial in revealing the complex relationships between genetic mutations, respiratory system function, and the pathogenesis of COPD.

In addition to Alpha-1 Antitrypsin deficiency, several additional genetic variables may increase the risk of developing COPD [75][76][75]. Variations in genes linked to lung development, like surfactant proteins, and mucin synthesis, which influences the viscosity and clearance of airway mucus, have been linked [53]. These differences may interfere with regular breathing patterns, making a person more susceptible to environmental stressors and accelerating

the onset of COPD. Furthermore, genetic changes that affect how the body reacts to oxidative stress are also important [62]. The lungs capacity to combat dangerous free radicals can be weakened by mutations in genes related to antioxidant defenses, such as glutathione S-transferase (GST) genes [47]. This can lead to tissue damage and persistent inflammation that are characteristic of COPD. New susceptibility genes and pathways are being discovered as part of ongoing research into the genetic basis of COPD [73]. A deeper comprehension of each person's unique illness risk and progression is made possible by the combination of genetic data and environmental risk factors. Understanding these genetic predispositions is promising for the development of targeted medicines focused at reducing the genetic contributions to COPD and hence improving lung health outcomes [28]. It also helps identify individuals who are at risk early. The need for tailored treatment in controlling and preventing this complicated respiratory condition is highlighted by the growing understanding of the complex genetic landscape of COPD. Conversely, recent studies indicate that histone modifications—alterations to the proteins that envelop DNA—may have a role in the etiology of COPD [73]. Histone modifications are essential in the control of gene expression [54]. Changes in acetylation, methylation, and phosphorylation patterns are the main histone modifications linked to COPD [55]. These modifications also contribute to the deregulation of important genes linked to inflammation, tissue remodeling, and oxidative stress. It has been said that abnormal histone acetylation in COPD affects the accessibility of genes related to the inflammatory response [56]. The pro-inflammatory mediators' genes may be more highly expressed because of increased histone acetylation, which would sustain the persistent inflammation that is a hallmark of COPD. On the other hand, anti-inflammatory genes have been linked to histone deacetylation, which leads to gene silence and exacerbates the inflammatory cascade in the lungs [58]. In addition, histone methylation patterns are essential to the pathophysiology of COPD [78]. It has been determined that there are modifications in the methylation status, especially in genes involved in tissue remodeling and repair [63]. The natural repair processes in the lungs may be compromised by altered histone methylation, which could be one of the reasons behind the progressive loss in respiratory function seen in COPD patients. Moreover, phosphorylation of histones, a dynamic alteration linked to several cellular functions, has been connected to oxidative stress in COPD [78]. The activation of genes involved in antioxidant defense mechanisms may be influenced by histone phosphorylation, and deregulation of this process may lead to an increased vulnerability to oxidative damage, which is a critical element in the progression of COPD [78]. On the other hand, long non-coding RNA has been shown to have epigenetically potential to create modifications within the genome [62]. RNA molecules classified as long non-coding RNAs (lncRNAs) do not function as templates for protein production, in contrast to their protein-coding counterparts [78]. Rather, they are essential for controlling several biological functions, such as the expression of genes, chromatin remodeling, and epigenetic changes. Due to their participation in several physiological and pathological diseases, such as COPD, long non-coding RNAs have attracted a lot of attention recently [46].

Several lncRNAs have been linked to the onset and progression of COPD. For instance, it has been discovered that COPD patients' lungs have elevated levels of the lncRNA H19, and that deregulation of this gene is linked to higher levels of inflammation and oxidative stress [48][54]. MALAT1 (Metastasis-Associated Lung Adenocarcinoma Transcript 1) is another lncRNA that has been connected to the severity and advancement of COPD [48]. MALAT1 contributes to the tissue remodeling observed in COPD by influencing the migration and proliferation of lung fibroblasts [41].

## 5 DNA Hypermethylation is Prominent in COPD

One important epigenetic process that has been linked to the development and increased risk of COPD is DNA methylation, specifically hypermethylation [73][74]. Gene expression patterns can be changed as a result of hypermethylation, which is the addition of methyl groups to particular cytosine residues inside the DNA molecule [72]. Hypermethylation has been linked to changes in important genes and pathways related to inflammation, tissue repair, and respiratory function in the context of COPD [73].

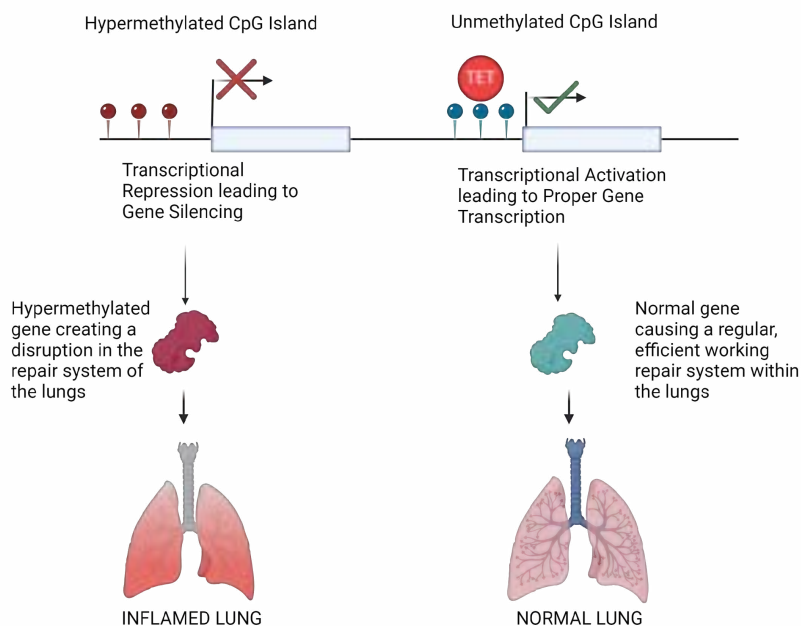

Figure 4: Hypermethylation's effect on the lungs

Hypermethylation has the potential to increase the risk of COPD by inhibiting genes linked to lung development and upkeep [68]. For example, the inability of the respiratory system to heal from harm brought on by things like cigarette smoke or environmental contaminants may be hampered by the hypermethylation of genes involved in lung tissue regeneration and repair [54]. This impaired repair mechanism may be a factor in the COPD-associated gradual reduction



in lung function. Moreover, genes linked to inflammatory processes have been found to be hypermethylated [78]. One of the main characteristics of COPD is chronic inflammation, which may be made worse by hypermethylation-induced inhibition of anti-inflammatory genes or activation of pro-inflammatory genes [80]. Prolonged inflammation has the potential to cause tissue damage, reshape airways, and cause the typical airflow restriction linked to COPD [80].

Moreover, oxidative stress is a major component in the pathophysiology of COPD and greater vulnerability to it may result from hypermethylation in genes linked to antioxidant defense mechanisms [81]. Hypermethylation-induced reduced antioxidant capacity can lead to an imbalance between the generation and neutralization of reactive oxygen species, which can cause oxidative damage and exacerbate lung inflammation [72].

Therefore, a major factor contributing to the increased risk of developing COPD is hypermethylation genes linked to lung growth, inflammation, and oxidative stress [76]. Comprehending the epigenetic alterations implicated in the etiology of COPD, such as hypermethylation, provides opportunities for focused therapeutic approaches that target DNA methylation patterns to slow down the disease's course and enhance patient outcomes [78].

However, research on the familial clustering of COPD has found potentially heritable DNA methylation patterns [76]. Understanding the genetic foundation of COPD risk can be gained by examining the epigenetic changes in certain genes linked to vulnerability to the disease [72][79]. A possible hereditary component of epigenetic regulation in COPD has been highlighted by familial studies that have revealed certain genomic areas where DNA methylation patterns may be altered in individuals with a family history of the disease [81]. Furthermore, genetic variations linked to COPD risk have been found using genome-wide association studies (GWAS), and some of these variants have been connected to alterations in DNA methylation [82]. GWAS is a tool that can be used to scan the genomes of thousands of individuals, to identify genetic variations associated with traits or diseases across the entire genome [79][82]. GWAS can pinpoint single nucleotide polymorphisms (SNPs) or other genetic markers that are statistically linked to the trait or condition of interest [82]. The results from the GWAS imply that hereditary variables may impact the epigenetic environment, resulting in modified DNA methylation patterns that may raise the chance of getting COPD [82][81]. DNA methylation is a crucial mediator in the dynamic process of gene expression regulation that underlies the interplay between genetic and epigenetic variables [79]. Comprehending the hereditary susceptibility to COPD by DNA methylation holds wider consequences for customized healthcare and prophylactic measures. The Interleukin-1 Beta IL1B gene is one that is impacted by DNA hypermethylation in the context of COPD [45]. The IL1B gene is related to a pro-inflammatory cytokine involved in the immune response. IL1B plays a critical role in mediating inflammation and immune reactions [54][21]. The pathophysiology of COPD has been linked to deregulation of IL1B expression, which is essential to the inflammatory response in the lungs [22]. People with COPD have been shown to have DNA hypermethylation of the IL1B gene promoter region, which lowers the levels of gene expression. This abnormal methylation pattern is a contributing factor to COPD's chronic inflammation and tissue destruction [21]. Prolonged exposure to

cigarette smoke and other environmental contaminants causes lung tissue and airways to remain inflamed in people with COPD [24]. The expression of the IL1B gene is silenced by hypermethylation of its promoter region, which lowers interleukin-1 beta levels [29]. In individuals with COPD, this dysregulation exacerbates the inflammatory response and accelerates the course of their disease by upsetting the equilibrium of inflammatory mediators in the lungs [22]. Additionally, tissue repair mechanisms may be compromised and the structural alterations in the alveoli and airways associated with COPD may be aggravated by the downregulation of IL1B brought on by DNA hypermethylation [75]. Matrix metalloproteinases (MMPs) and other proteases that aid in tissue remodeling and healing are regulated by IL1B. Decreased expression of IL1B hinders the lungs' capacity to heal from inflammation induced damage, which causes the condition of COPD patients to worsen in terms of airflow restriction and respiratory symptoms [76]. Finding people with DNA methylation profiles linked to an increased risk of COPD may make it possible to implement targeted interventions, such as early lifestyle changes, monitoring, and possibly even the creation of preventive treatments. [75]. It's crucial to remember that COPD is a multifaceted illness, and that the intricate interactions between genetic and environmental factors that contribute to its development are unlikely to be entirely explained by genetic predisposition alone [79].

## **6 Therapeutic Solution**

In the context of COPD, therapeutic interventions that target DNA methylation offer a promising frontier in the search for novel treatment approaches [15]. A major factor in the pathophysiology of COPD is the disruption of DNA methylation patterns, which impacts important genes related to oxidative stress, inflammation, and tissue repair. Using cutting-edge technology, such as CRISPR-Cas9 and other recently developed medical technologies, presents previously unheard-of possibilities for accuracy when treating the epigenetic changes linked to COPD [16].

### **6.1 The Current State of COPD Treatment**

Currently, the medical community treats COPD using a multimodal strategy that aims to manage symptoms, improve lung function, and improve the overall quality of life for those who are afflicted [17][18]. Bronchodilators are frequently recommended to treat airflow restriction and lessen symptoms like dyspnea. These include anticholinergics and both short- and long-acting beta-agonists [21]. For patients with more severe COPD or those who experience exacerbations often, inhaled corticosteroids may be added [20]. These pharmaceutical therapies address the main physiological issues related to COPD by aiding in bronchodilation and inflammation control [19]. Programs for pulmonary rehabilitation, which place a strong emphasis on exercise instruction, education, and nutritional support, are essential parts of managing COPD [21]. Enhancing exercise tolerance, lowering dyspnea, and equipping patients with self-management techniques are the goals of these programs. Quitting smoking is one of the most important lifestyles changes you can make to decrease the progression of your disease. The

most effective management for COPD patients is still quitting smoking, which dramatically lowers the rate of lung function decrease and improves overall health outcomes [18].

## **6.2 Current Treatment of COPD Has Unanswered Issues**

Even with advancements in COPD treatment, patients are still affected by unfavorable characteristics and enduring obstacles [21]. One major worry is that COPD is still an incurable, progressive illness, and most existing medications are aimed at managing symptoms rather than curing the illness. Due to this restriction, patients frequently must contend with the disease's cumulative effects on their respiratory system and general health for the rest of their lives [19][20]. The possibility of side effects from prolonged pharmaceutical use, especially with inhaled corticosteroids, is another drawback [26]. Adverse effects such as oral thrush, a higher risk of pneumonia, and systemic symptoms could add to the difficulties that patients already face when adjusting to the complicated nature of COPD [28]. Furthermore, certain individuals may not exhibit optimal response to conventional pharmaceutical interventions, underscoring the necessity for more individualized and efficacious therapeutic alternatives [27]. Furthermore, it is impossible to ignore the socioeconomic cost of treating COPD [27]. Patients may experience financial difficulties due to the expenses of prescription drugs, pulmonary rehabilitation programs, and hospital stays, which can put a burden on healthcare systems. The detrimental effects of existing COPD treatments are highlighted by their influence on everyday functioning and quality of life, as well as the psychological cost of having a chronic and progressive condition [28]. Addressing these issues and creating more focused and effective interventions will be essential as medical research develops to improve results and lessen the burdens that COPD patients bear.

## **6.3 A Novel Remedy: CRISPR**

Because of this, the treatment of COPD may be completely changed by cutting-edge medical technologies like CRISPR-Cas9 [47]. Clustered Regularly Interspaced Short Palindromic Repeats, or CRISPR, is a novel genome editing technique that has attracted a lot of interest due to its potential use in treating a variety of genetic diseases, including those linked to abnormal DNA methylation patterns like COPD [49]. The two primary parts of the CRISPR system—a Cas protein, also known as Cas9—and guide RNA (gRNA) are taken from a bacterial immune system [47]. The Cas protein functions as a molecular scissors and can cut DNA at the specified site, whereas the gRNA is intended to target a particular DNA sequence that is complementary to its sequence [48].

CRISPR-based epigenome editing techniques usually entail altering the DNA methylation patterns at genomic loci linked to the pathophysiology of the illness to address DNA hypermethylation in COPD [47]. The first step in this procedure is to create and synthesize a complementary gRNA to the target hypermethylated region of the genome. After that, the gRNA and Cas protein combine to form a ribonucleoprotein (RNP) complex, which is frequently transported into the target cells via lipid nanoparticles or viral vectors [42]. The CRISPR RNP

complex searches the genomic DNA for sequences that match the gRNA once it has entered the cell [52][47]. The Cas protein causes a double-stranded break in the DNA when it encounters the targeted hypermethylated area. The cell's DNA repair machinery is activated by this break, and through processes including base excision repair and homology directed repair, the hypermethylated cytosine residues may be replaced or removed [42]. CRISPR-based epigenome editing seeks to restore normal gene expression levels and reduce inflammation in COPD patients by altering the DNA methylation patterns at particular loci [57].

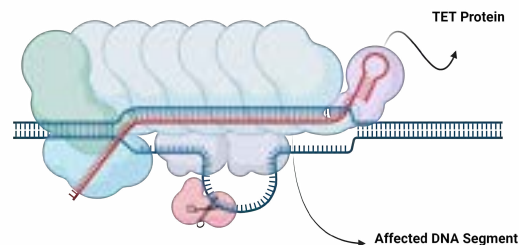

Figure 5: The use of a TET Protein from CRISPR Cas9 to remediate an epigenetically affected DNA Strand

Targeting genes associated with inflammation and tissue remodeling—two major causes of the persistent airway blockage observed in COPD—is one area of focus for CRISPR treatment of COPD [57]. Through targeted gene modification linked to these mechanisms, CRISPR may be able to reduce or even reverse the inflammatory response and the advancement of COPD [34]. Furthermore, CRISPR might provide a more individualized strategy by enabling the creation of personalized treatments based on each patient's own genetic makeup. Several medical approaches are being researched to modify DNA methylation in addition to CRISPR [31].

#### 6.4 Other Solutions for COPD Therapy

Zinc finger proteins and transcription activator-like effector nucleases, or TALENs, are examples of epigenome-editing technologies that offer substitute techniques for precise alterations of DNA methylation patterns [43][51]. With the help of these technologies, it is possible to precisely construct enzymes with the ability to add or remove methyl groups at genomic loci [55]. This level of specificity shows potential for use in COPD therapy. Additionally, research is being done on tiny compounds that target DNA methyltransferases (DNMTs), which are the enzymes that add methyl groups to DNA [56]. Preclinical research has demonstrated the potential of DNMT inhibitors, including decitabine and azacitidine, to correct abnormal DNA methylation patterns. There is optimism for the development of pharmaceutical

therapies that could normalize DNA methylation and change the course of the disease since clinical trials examining the safety and effectiveness of these inhibitors in COPD patients are now underway [56][57][58].

### **6.5 Potential Use of Precision Medicine for COPD**

Despite being in its early phases of research, these therapeutic methods highlight the potential of precision medicine in the therapy of COPD [61]. But before these technologies are extensively used in clinical settings, issues including off-target effects and long-term safety concerns need to be resolved [64]. The incorporation of these state-of-the-art technologies into the COPD treatment landscape signifies a paradigm shift toward more individualized and focused interventions, with the potential to improve quality of life and outcomes for those afflicted with this crippling respiratory disease. Apart from genome editing and epigenome modification technologies, current investigations are looking into the possibility of merging these methods with conventional pharmaceutical interventions [63][64]. Targeted DNA methylation changes and already prescribed COPD drugs, such as bronchodilators and anti-inflammatory medicines, may work in concert to offer a comprehensive and multimodal therapeutic approach [61]. With an eye toward a more comprehensive and successful treatment outcome, this integrated strategy aims to address both the underlying epigenetic changes and the clinical manifestations of COPD [64][61][63]. A further line of investigation for customized treatment in COPD is patient categorization based on epigenetic profiling [64][65]. Through the identification of distinct DNA methylation patterns linked to various COPD phenotypes, medical professionals can customize therapy approaches to the distinct biological attributes of individual patients [66]. This strategy improves therapeutic precision while also paving the way for a more sophisticated knowledge of the heterogeneity within COPD [67]. This will enable more precise prognostication and tailored therapies that correspond with the unique pathophysiological pathways in each case [68][69].

#### **6.6 A Senolytic Approach**

On the other hand, senolytics, is emerging as a promising therapeutic approach in the realm of COPD, by specifically targeting senescent cells [83]. By selectively eliminating senescent cells, senolytics aim to alleviate inflammation, promote tissue repair, and improve lung function in COPD patients [84]. Preclinical studies utilizing various senolytic agents have shown promising results in mitigating lung inflammation, reducing fibrosis, and restoring lung function in animal models of COPD [85]. Moreover, the potential benefits of senolytic therapy extend beyond the lungs, as senescent cell clearance has been associated with improvements in age-related comorbidities commonly observed in COPD patients, such as cardiovascular diseases and osteoporosis [76]. While further research is needed to understand the safety and efficacy of senolytic therapies in COPD, targeting senescent cells holds significant promise as a novel therapeutic strategy for combating the progressive decline in lung function and improving outcomes in COPD patients [78].

A deeper understanding of the epigenetic landscape and the rapid advancement of genome-editing technologies hold immense potential for revolutionary changes in COPD therapy, even though the therapeutic landscape for targeting DNA methylation in COPD is still changing. Molecular biologists, physicians, and pharmaceutical developers working together will be essential to bringing these discoveries from the bench to the bedside and, in the end, offering patients suffering from COPD new and efficient treatment options.

## References

- [1] RAPPAPORT, STEPHEN M. “Long-Term Modulation of Electrical Synapses in the Mammalian Thalamus.” *Environment and Disease Risks, Science*, [www.science.org/doi/10.1126/science.1192603](http://www.science.org/doi/10.1126/science.1192603). Accessed 10 Jan. 2024.
- [2] Scholthof, Karen-Beth G. “The Disease Triangle: Pathogens, the Environment and Society.” *Nature News*, Nature Publishing Group, 27 Dec. 2006, [www.nature.com/articles/nrmicro1596](http://www.nature.com/articles/nrmicro1596). Hill AB.
- [3] The environment and disease: association or causation? *Journal of the Royal Society of Medicine*. 2015;108(1):32-37. doi:10.1177/0141076814562718
- [4] J.Timothy Greenamyre, et al. “The Rotenone Model of Parkinson’s Disease: Genes, Environment and Mitochondria.” *Parkinsonism Related Disorders*, Elsevier, 14 June 2003, [www.sciencedirect.com/science/article/abs/pii/S1353802003000233](http://www.sciencedirect.com/science/article/abs/pii/S1353802003000233).
- [5] Petty, Thomas. “The History of COPD.” Taylor Francis Online, [www.tandfonline.com/doi/full/10.2147/copd.2006.1.1.3](http://www.tandfonline.com/doi/full/10.2147/copd.2006.1.1.3). Accessed 11 Jan. 2024.
- [6] Cavaill`es, Arnaud, et al. “Comorbidities of COPD.” *European Respiratory Society*, European Respiratory Society, 1 Dec. 2013, [err.ersjournals.com/content/22/130/454.short](http://err.ersjournals.com/content/22/130/454.short).
- [7] Emil F.M. Wouters MD, et al. “Systemic Effects in COPD.” *Chest*, Elsevier, 16 Dec. 2015, [www.sciencedirect.com/science/article/abs/pii/S0012369215353770](http://www.sciencedirect.com/science/article/abs/pii/S0012369215353770).
- [8] Barnes, P. J., and B. R. Celli. “Systemic Manifestations and Comorbidities of COPD.” *European Respiratory Society*, European Respiratory Society, 1 May 2009, [erj.ersjournals.com/content/33/5/1165.short](http://erj.ersjournals.com/content/33/5/1165.short).
- [9] Sin, D. D., et al. “Mortality in COPD: Role of Comorbidities.” *European Respiratory Society*, European Respiratory Society, 1 Dec. 2006, [erj.ersjournals.com/content/28/6/1245.short](http://erj.ersjournals.com/content/28/6/1245.short).
- [10] *The Lancet*, 08 April 2023, Volume 401, Issue 10383, Pages 1131-1240, [www.thelancet.com/journals/lancet/article/PIIS0140-6736\(04\)17175-4/abstract](http://www.thelancet.com/journals/lancet/article/PIIS0140-6736(04)17175-4/abstract). Accessed 11 Jan. 2024.
- [11] Eeden, Stephan&nbsp;F., and James&nbsp;C. Hogg. “Immune-Modulation in Chronic Obstructive Pulmonary Disease: Current Concepts and Future Strategies.” Karger Publishers, S. Karger AG, 3 Sept. 2019, [karger.com/res/article/99/7/550/290904/Immune-Modulation-in-Chroni-Obstructive-Pulmonary](http://karger.com/res/article/99/7/550/290904/Immune-Modulation-in-Chroni-Obstructive-Pulmonary).
- [12] “COPD.” Mayo Clinic, Mayo Foundation for Medical Education and Research, 15 Apr. 2020, [www.mayoclinic.org/diseases-conditions/copd/symptoms-causes/syc-20353679](http://www.mayoclinic.org/diseases-conditions/copd/symptoms-causes/syc-20353679).
- [13] “Chronic Obstructive Pulmonary Disease (COPD).” Centers for Disease Control and Prevention, Centers for Disease Control and Prevention, 30 June 2023, [www.cdc.gov/copd/index.html](http://www.cdc.gov/copd/index.html).
- [14] JB;, LÁLopez-Campos JL;Tan W;Soriano. “Global Burden of COPD.” *Respirology* (Carlton, Vic.), U.S. National Library of Medicine, [pubmed.ncbi.nlm.nih.gov/26494423/](http://pubmed.ncbi.nlm.nih.gov/26494423/). Accessed 12 Jan. 2024.

- [15] David M. Mannino MD, et al. “COPD: Epidemiology, Prevalence, Morbidity and Mortality, and Disease Heterogeneity.” *Chest*, Elsevier, 16 Dec. 2015, [www.sciencedirect.com/science/article/abs/pii/S0012369215353769](http://www.sciencedirect.com/science/article/abs/pii/S0012369215353769).
- [16] Turato, Graziella, et al. “Pathogenesis and Pathology of COPD.” Karger Publishers, S. Karger AG, 29 Mar. 2001, [karger.com/res/articleabstract/68/2/117/288341/Pathogenesis-and-Pathology-of-COPD](http://karger.com/res/articleabstract/68/2/117/288341/Pathogenesis-and-Pathology-of-COPD).
- [17] Sean D. Sullivan PhD a c, et al. “The Economic Burden of COPD.” *Chest*, Elsevier, 30 Dec. 2015, [www.sciencedirect.com/science/article/abs/pii/S0012369215527487](http://www.sciencedirect.com/science/article/abs/pii/S0012369215527487).
- [18] *The Lancet*, 08 April 2023, Volume 401, Issue 10383, Pages 1131-1240, [www.thelancet.com/journals/lancet/article/PIIS0140-6736\(07\)61377-4/abstract](http://www.thelancet.com/journals/lancet/article/PIIS0140-6736(07)61377-4/abstract). Accessed 13 Jan. 2024.
- [19] Ana S.M. Afonso a d, et al. “COPD in the General Population: Prevalence, Incidence and Survival.” *Respiratory Medicine*, W.B. Saunders, 17 Aug. 2011, [www.sciencedirect.com/science/article/pii/S0954611111002125](http://www.sciencedirect.com/science/article/pii/S0954611111002125).
- [20] Echevarria, Carlos, et al. “Oxygen Therapy and Inpatient Mortality in COPD Exacerbation.” *Emergency Medicine Journal*, BMJ Publishing Group Ltd and the British Association for Accident Emergency Medicine, 1 Mar. 2021, [emj.bmj.com/content/38/3/170.abstract](http://emj.bmj.com/content/38/3/170.abstract). Wiley Online Library — Scientific Research Articles, Journals, ..., [onlinelibrary.wiley.com/](http://onlinelibrary.wiley.com/). Accessed 15 Jan. 2024.
- [21] T.nnesen, Philip. “Smoking Cessation and COPD.” *European Respiratory Society*, European Respiratory Society, 1 Mar. 2013, [err.ersjournals.com/content/22/127/37.short](http://err.ersjournals.com/content/22/127/37.short).
- [22] Donald P. Tashkin a, et al. “Smoking Cessation in Chronic Obstructive Pulmonary Disease.” *Respiratory Medicine*, W.B. Saunders, 14 Mar. 2009, [www.sciencedirect.com/science/article/pii/S0954611109000651](http://www.sciencedirect.com/science/article/pii/S0954611109000651).
- [23] Lapperre, T S, et al. “Relation between Duration of Smoking Cessation and Bronchial Inflammation in COPD.” *Thorax*, BMJ Publishing Group Ltd, 1 Feb. 2006, [thorax.bmj.com/content/61/2/115.short](http://thorax.bmj.com/content/61/2/115.short).
- [24] Strassmann, R., et al. “Smoking Cessation Interventions in COPD: A Network Meta-Analysis of Randomized Trials.” *European Respiratory Society*, European Respiratory Society, 1 Sept. 2009, [erj.ersjournals.com/content/34/3/634.short](http://erj.ersjournals.com/content/34/3/634.short).
- [25] Miravittles, Marc, and Anna Ribera. “Understanding the Impact of Symptoms on the Burden of COPD - Respiratory Research.” *BioMed Central*, BioMed Central, 21 Apr. 2017, [respiratory-research.biomedcentral.com/articles/10.1186/s12931-017-0548-3](http://respiratory-research.biomedcentral.com/articles/10.1186/s12931-017-0548-3).
- [26] Claus F. Vogelmeier a, et al. “Goals of COPD Treatment: Focus on Symptoms and Exacerbations.” *Respiratory Medicine*, W.B. Saunders, 21 Mar. 2020, [www.sciencedirect.com/science/article/pii/S0954611120300780](http://www.sciencedirect.com/science/article/pii/S0954611120300780).



- [27] Marianne Voll-Aanerud a, et al. “Respiratory Symptoms, COPD Severity, and Health Related Quality of Life in a General Population Sample.” *Respiratory Medicine*, W.B. Saunders, 3 Dec. 2007, [www.sciencedirect.com/science/article/pii/S0954611107004349](http://www.sciencedirect.com/science/article/pii/S0954611107004349).
- [28] Jill A. Ohar MD, et al. “Do Symptoms Predict COPD in Smokers?” *Chest*, Elsevier, 16 Dec. 2015, [www.sciencedirect.com/science/article/abs/pii/S0012369210602875](http://www.sciencedirect.com/science/article/abs/pii/S0012369210602875).
- [29] Ranu, Harpreet, et al. “Pulmonary Function Tests.” *The Ulster Medical Journal*, U.S. National Library of Medicine, May 2011, [www.ncbi.nlm.nih.gov/pmc/articles/PMC3229853/](http://www.ncbi.nlm.nih.gov/pmc/articles/PMC3229853/).
- [30] Kristina L. Bailey MD, et al. “The Importance of the Assessment of Pulmonary Function in COPD.” *Medical Clinics of North America*, Elsevier, 31 May 2012, [www.sciencedirect.com/science/article/abs/pii/S0025712512000764](http://www.sciencedirect.com/science/article/abs/pii/S0025712512000764).
- [31] Scharm, Sarah C, et al. “Increased Regional Ventilation as Early Imaging Marker for Future Disease Progression of Interstitial Lung Disease: A Feasibility Study.” *European Radiology*, U.S. National Library of Medicine, Sept. 2022, [www.ncbi.nlm.nih.gov/pmc/articles/PMC9381456/](http://www.ncbi.nlm.nih.gov/pmc/articles/PMC9381456/).
- [32] Combined Forced Expiratory Volume in 1 Second and Forced Vital ..., [www.atsjournals.org/doi/full/10.1513/AnnalsATS.201809-601OC](http://www.atsjournals.org/doi/full/10.1513/AnnalsATS.201809-601OC). Accessed 24 Jan.2024.
- [33] Moon, Seong Mi, et al. “Clinical Impact of Forced Vital Capacity on Exercise Performance in Patients with Chronic Obstructive Pulmonary Disease.” *Journal of Thoracic Disease*, U.S. National Library of Medicine, Feb. 2021, [www.ncbi.nlm.nih.gov/pmc/articles/PMC7947547/](http://www.ncbi.nlm.nih.gov/pmc/articles/PMC7947547/).
- Http://Journals.Sagepub.Com/Doi/Abs/10.1177/0887302x07303626 —
- [35] “Aging Changes in Immunity: Medlineplus Medical Encyclopedia.” *MedlinePlus*, U.S. National Library of Medicine, [medlineplus.gov/ency/article/004008.htm](http://medlineplus.gov/ency/article/004008.htm). Accessed 23 Feb. 2024.
- [36] Kotlyarov, Stanislav. “Involvement of the Innate Immune System in the Pathogenesis of Chronic Obstructive Pulmonary Disease.” *MDPI, Multidisciplinary Digital Publishing Institute*, 17 Jan. 2022, [www.mdpi.com/1422-0067/23/2/985](http://www.mdpi.com/1422-0067/23/2/985).
- [37] Caramori, Gaetano, et al. “COPD Immunopathology - Seminars in Immunopathology.” *SpringerLink*, Springer Berlin Heidelberg, 13 May 2016, [link.springer.com/article/10.1007/s00281-016-0561-5](http://link.springer.com/article/10.1007/s00281-016-0561-5). *Ashpublications.Org*, [ashpublications.org/blood/article/93/12/4059/260904/DNA-Methylation](http://ashpublications.org/blood/article/93/12/4059/260904/DNA-Methylation). Accessed 23 Jan. 2024.
- [38] Marta Kulis, et al. “DNA Methylation and Cancer.” *Advances in Genetics*, Academic Press, 2 Oct. 2010, [www.sciencedirect.com/science/article/abs/pii/B9780123808660600022](http://www.sciencedirect.com/science/article/abs/pii/B9780123808660600022).
- [39] Robertson, Keith D., and Peter A.Jones. “DNA Methylation: Past, Present and Future Directions.” *OUP*

- Academic, Oxford University Press, 1 Mar. 2000,  
[academic.oup.com/carcin/article/21/3/461/2365668](http://academic.oup.com/carcin/article/21/3/461/2365668).
- [40] Variable DNA Methylation Is Associated with Chronic Obstructive ...,  
[www.atsjournals.org/doi/full/10.1164/rccm.201108-1382OC](http://www.atsjournals.org/doi/full/10.1164/rccm.201108-1382OC). Accessed 24 Jan. 2024.
- [41] He, Lin-Xi, et al. "DNA Methylation: A Potential Biomarker of Chronic Obstructive  
 Pulmonary Disease." *Frontiers*, Frontiers, 16 June 2020,  
[www.frontiersin.org/articles/10.3389/fcell.2020.00585/full](http://www.frontiersin.org/articles/10.3389/fcell.2020.00585/full).
- [42] Michael Kabesch a b, et al. "Epigenetics in Asthma and COPD." *Biochimie*, Elsevier, 30  
 July 2012,  
[www.sciencedirect.com/science/article/abs/pii/S0300908412002994](http://www.sciencedirect.com/science/article/abs/pii/S0300908412002994).
- [43] Golpon, H A, et al. "Hox Genes in Human Lung: Altered Expression in Primary Pulmonary  
 Hypertension and Emphysema." *The American Journal of Pathology*, U.S. National  
 Library of Medicine, Mar. 2001,  
[www.ncbi.nlm.nih.gov/pmc/articles/PMC1850338/](http://www.ncbi.nlm.nih.gov/pmc/articles/PMC1850338/).
- [44] Linling Cheng MD, et al. "Cigarette Smoke-Induced Hypermethylation of the GCLC Gene  
 Is Associated with COPD." *Chest*, Elsevier, 12 Jan. 2016,  
[www.sciencedirect.com/science/article/abs/pii/S0012369215001087](http://www.sciencedirect.com/science/article/abs/pii/S0012369215001087).
- [45] Linling Cheng MD, et al. "Cigarette Smoke-Induced Hypermethylation of the GCLC Gene  
 Is Associated with COPD." *Chest*, Elsevier, 12 Jan. 2016,  
[www.sciencedirect.com/science/article/abs/pii/S0012369215001087](http://www.sciencedirect.com/science/article/abs/pii/S0012369215001087).
- [46] Du, Xizi, et al. "Variable DNA Methylation of Aging-Related Genes Is Associated with  
 Male COPD - Respiratory Research." *BioMed Central*, BioMed Central, 4 Nov. 2019,  
[respiratory-research.biomedcentral.com/articles/10.1186/s12931-019-1215-7](http://respiratory-research.biomedcentral.com/articles/10.1186/s12931-019-1215-7).—*Science  
 Advances*, [www.science.org/doi/10.1126/sciadv](http://www.science.org/doi/10.1126/sciadv). Accessed 24 Jan. 2024.
- [47] Shaikh, Sadiya B., and Yashodhar Prabhakar Bhandary. "CRISPR/Cas9 Genome Editing  
 Tool: A Promising Tool for Therapeutic Applications on Respiratory Diseases." *Latest  
 TOC RSS*, Bentham Science Publishers, 1 Jan. 1970,  
[www.ingentaconnect.com/content/ben/cgt/2020/00000020/00000005/art00003](http://www.ingentaconnect.com/content/ben/cgt/2020/00000020/00000005/art00003).
- [48] Dan-Dan Wu a b c, et al. "The Potential for Targeted Rewriting of Epigenetic Marks in  
 COPD as a New Therapeutic Approach." *Pharmacology & Therapeutics*, Pergamon, 19  
 Aug. 2017,  
[www.sciencedirect.com/science/article/pii/S0163725817302176](http://www.sciencedirect.com/science/article/pii/S0163725817302176).
- [49] Wang, Cuixue, et al. "Progress in the Mechanism and Targeted Drug Therapy for COPD."  
*Nature News*, Nature Publishing Group, 27 Oct. 2020,  
[www.nature.com/articles/s41392-020-00345-x](http://www.nature.com/articles/s41392-020-00345-x).
- [50] Jonathan R. Baker PhD, et al. "Senotherapy: A New Horizon for COPD Therapy." *Chest*,  
 Elsevier, 10 Feb. 2020,  
[www.sciencedirect.com/science/article/abs/pii/S001236922030252X](http://www.sciencedirect.com/science/article/abs/pii/S001236922030252X).

- [51] Barnes, Peter J. "Emerging Targets for COPD Therapy." Latest TOC RSS, Bentham Science Publishers, 1 Jan. 1970, [www.ingentaconnect.com/content/ben/cdtia/2005/00000004/00000006/art00008](http://www.ingentaconnect.com/content/ben/cdtia/2005/00000004/00000006/art00008).
- [52] Easter, Molly, et al. "Targeting Aging Pathways in Chronic Obstructive Pulmonary Disease." MDPI, Multidisciplinary Digital Publishing Institute, 21 Sept. 2020, [www.mdpi.com/1422-0067/21/18/6924](http://www.mdpi.com/1422-0067/21/18/6924).
- [53] Sidhaye, Venkataramana K., et al. "Precision Medicine in COPD: Where Are We and Where Do We Need to Go?" European Respiratory Society, European Respiratory Society, 30 Sept. 2018, [err.ersjournals.com/content/27/149/180022](http://err.ersjournals.com/content/27/149/180022).
- [54] Dan-Dan Wu a b c, et al. "The Potential for Targeted Rewriting of Epigenetic Marks in COPD as a New Therapeutic Approach." Pharmacology Therapeutics, Pergamon, 19 Aug. 2017, [www.sciencedirect.com/science/article/pii/S0163725817302176](http://www.sciencedirect.com/science/article/pii/S0163725817302176).
- [55] Zeng, Huihui, et al. "Oxidative Stress Mediates the Apoptosis and Epigenetic Modification of the Bcl-2 promoter via DNMT1 in a Cigarette Smoke-Induced Emphysema Model - Respiratory Research." BioMed Central, BioMed Central, 3 Sept. 2020, [respiratory-research.biomedcentral.com/articles/10.1186/s12931-020-01495-w](http://respiratory-research.biomedcentral.com/articles/10.1186/s12931-020-01495-w).
- [56] Jen, Jayu, and Yi-Ching Wang. "Zinc Finger Proteins in Cancer Progression-Journal of Biomedical Science." BioMed Central, BioMed Central, 13 July 2016, [jbiomedsci.biomedcentral.com/articles/10.1186/s12929-016-0269-9](http://jbiomedsci.biomedcentral.com/articles/10.1186/s12929-016-0269-9).
- [57] Cassandri, Matteo, et al. "Zinc-Finger Proteins in Health and Disease." Nature News, Nature Publishing Group, 13 Nov. 2017, [www.nature.com/articles/cddiscovery201771](http://www.nature.com/articles/cddiscovery201771).
- [58] Singh, Dave. "Pharmacological Treatment for COPD; Gold 2017 Changes Direction." British Journal of Clinical Pharmacology, U.S. National Library of Medicine, May 2017, [www.ncbi.nlm.nih.gov/pmc/articles/PMC5401983/](http://www.ncbi.nlm.nih.gov/pmc/articles/PMC5401983/).
- [59] Decramer, Marc, and Christopher B Cooper. "Treatment of COPD: The Sooner the Better?" Thorax, BMJ Publishing Group Ltd, 1 Sept. 2010, [thorax.bmj.com/content/65/9/837.short](http://thorax.bmj.com/content/65/9/837.short).
- [60] Barnes, P. J., and R. A. Stockley. "COPD: Current Therapeutic Interventions and Future Approaches." European Respiratory Society, European Respiratory Society, 1 June 2005, [erj.ersjournals.com/content/25/6/1084.short](http://erj.ersjournals.com/content/25/6/1084.short).
- [61] Charlene E McEvoy MD, et al. "Adverse Effects of Corticosteroid Therapy for COPD: A Critical Review." Chest, Elsevier, 24 Mar. 2016, [www.sciencedirect.com/science/article/abs/pii/S0012369215468308](http://www.sciencedirect.com/science/article/abs/pii/S0012369215468308).
- [62] Branson, Richard D. "Oxygen Therapy in COPD." American Association for Respiratory Care, Respiratory Care, 1 June 2018, [rc.rcjournal.com/content/63/6/734.short](http://rc.rcjournal.com/content/63/6/734.short).
- [63] Rau, Joseph L. "Practical Problems with Aerosol Therapy in COPD." American Association for Respiratory Care, Respiratory Care, 1 Feb. 2006, [rc.rcjournal.com/content/51/2/158.short](http://rc.rcjournal.com/content/51/2/158.short).

- [64] A Challenge to the Seven Widely Believed Concepts of COPD, [www.tandfonline.com/doi/full/10.2147/copd.s38714](http://www.tandfonline.com/doi/full/10.2147/copd.s38714). Accessed 24 Jan. 2024.
- [65] Laia Llin`as a, et al. "Similar Gene Expression Profiles in Smokers and Patients with Moderate COPD." *Pulmonary Pharmacology Therapeutics*, Academic Press. 21 Oct. 2010, [www.sciencedirect.com/science/article/abs/pii/S1094553910001240](http://www.sciencedirect.com/science/article/abs/pii/S1094553910001240). [66] Castaldi, Peter J., et al. "The COPD Genetic Association Compendium: A Comprehensive Online Database of COPD Genetic Associations." OUP Academic, Oxford University Press, 20 Nov. 2009, academic.oup.com/hmg/article/19/3/526/600434.
- [67] Ali Masjedy a, et al. "Association between Single-Nucleotide Polymorphism of Cytokines Genes and Chronic Obstructive Pulmonary Disease: A Systematic Review and Meta-Analysis." *Cytokine*, Academic Press, 11 Sept. 2023, [www.sciencedirect.com/science/article/abs/pii/S1043466623002302](http://www.sciencedirect.com/science/article/abs/pii/S1043466623002302).
- [68] Shukla, Rajni Kant, et al. "Association of Cytokine Gene Polymorphisms in Patients with Chronic Obstructive Pulmonary Disease." *Oman Medical Journal*, U.S. National Library of Medicine, July 2012, [www.ncbi.nlm.nih.gov/pmc/articles/PMC3464746/](http://www.ncbi.nlm.nih.gov/pmc/articles/PMC3464746/).
- [69] Yi, Gao, et al. "A Large Lung Gene Expression Study Identifying IL1B as a Novel Player in Airway Inflammation in COPD Airway Epithelial Cells – Inflammation Research." SpringerLink, Springer International Publishing, 3 Apr. 2018, [link.springer.com/article/10.1007/s00011-018-1145-8](http://link.springer.com/article/10.1007/s00011-018-1145-8).
- [70] "DNA Methylation." *DNA Methylation - an Overview* — ScienceDirect Topics, [www.sciencedirect.com/topics/medicine-and-dentistry/dna-methylation](http://www.sciencedirect.com/topics/medicine-and-dentistry/dna-methylation). Accessed 24 Jan. 2024.
- [71] Jin, Bilian, et al. "DNA Methylation: Superior or Subordinate in the Epigenetic Hierarchy?" *Genes Cancer*, U.S. National Library of Medicine, June 2011, [www.ncbi.nlm.nih.gov/pmc/articles/PMC3174260/](http://www.ncbi.nlm.nih.gov/pmc/articles/PMC3174260/).
- [72] Kiselev, I S, et al. "DNA Methylation as an Epigenetic Mechanism in the Development of Multiple Sclerosis." *Acta Naturae*, U.S. National Library of Medicine, 2021, [www.ncbi.nlm.nih.gov/pmc/articles/PMC8327151/](http://www.ncbi.nlm.nih.gov/pmc/articles/PMC8327151/).
- [73] Moore, Lisa D, et al. "DNA Methylation and Its Basic Function." *Nature News*, Nature Publishing Group, 11 July 2012, [www.nature.com/articles/npp2012112](http://www.nature.com/articles/npp2012112).
- [74] Yang, Yiqi, and Gang Li. "Post-Translational Modifications of PRC2: Signals Directing Its Activity - Epigenetics Chromatin." *BioMed Central*, BioMed Central, 31 Oct. 2020, [epigeneticsandchromatin.biomedcentral.com/articles/10.1186/s13072-020-00369-1](http://epigeneticsandchromatin.biomedcentral.com/articles/10.1186/s13072-020-00369-1).
- [75] "Alpha-1 Antitrypsin Deficiency." *National Heart Lung and Blood Institute*, U.S. Department of Health and Human Services, [www.nhlbi.nih.gov/health/alpha-1-antitrypsin-deficiency](http://www.nhlbi.nih.gov/health/alpha-1-antitrypsin-deficiency). Accessed 24 Feb. 2024.

- [76] “Alpha-1 Antitrypsin Deficiency: Medlineplus Genetics.” MedlinePlus, U.S. National Library of Medicine, [medlineplus.gov/genetics/condition/alpha-1-antitrypsin-deficiency/](https://medlineplus.gov/genetics/condition/alpha-1-antitrypsin-deficiency/). Accessed 24 Feb. 2024.
- [77] UpToDate, [www.uptodate.com/contents/clinical-manifestations-diagnosis-and-natural-history-of-alpha-1-antitrypsin-deficiency](https://www.uptodate.com/contents/clinical-manifestations-diagnosis-and-natural-history-of-alpha-1-antitrypsin-deficiency). Accessed 24 Feb. 2024.
- [78] I, Sundar IK;Nevid MZ;Friedman AE;Rahman. “Cigarette Smoke Induces Distinct Histone Modifications in Lung Cells: Implications for the Pathogenesis of COPD and Lung Cancer.” Journal of Proteome Research, U.S. National Library of Medicine, [pubmed.ncbi.nlm.nih.gov/24283195/](https://pubmed.ncbi.nlm.nih.gov/24283195/). Accessed 24 Jan. 2024.
- [79] Clifford, Rachel L., et al. “Altered DNA Methylation Is Associated with Aberrant Gene Expression in Parenchymal but Not Airway Fibroblasts Isolated from Individuals with COPD - Clinical Epigenetics.” BioMed Central, BioMed Central, 5 Mar. 2018, [clinicalepigeneticsjournal.biomedcentral.com/articles/10.1186/s13148-018-0464-5](https://clinicalepigeneticsjournal.biomedcentral.com/articles/10.1186/s13148-018-0464-5).
- [80] Promoter DNA Hypermethylation and Paradoxical Gene Activation: ..., [www.cell.com/trends/cancer/fulltext/S2405-8033\(20\)30067-4](https://www.cell.com/trends/cancer/fulltext/S2405-8033(20)30067-4). Accessed 24 Feb.2024.
- [81] Rauluseviciute, Ieva, et al. “DNA Hypermethylation Associated with Upregulated Gene Expression in Prostate Cancer Demonstrates the Diversity of Epigenetic Regulation - BMC Medical Genomics.” BioMed Central, BioMed Central, 8 Jan. 2020, [bmcmmedgenomics.biomedcentral.com/articles/10.1186/s12920-020-0657-6](https://bmcmmedgenomics.biomedcentral.com/articles/10.1186/s12920-020-0657-6).
- [82] “*Genome-Wide Association Studies (GWAS)*.” *Genome.Gov*, [www.genome.gov/genetics-glossary/Genome-Wide-Association-Studies](https://www.genome.gov/genetics-glossary/Genome-Wide-Association-Studies). Accessed 24 Jan. 2024.
- [83] Justice, Jamie N, et al. “Senolytics in Idiopathic Pulmonary Fibrosis: Results from a First-in-Human, Open-Label, Pilot Study.” EBioMedicine, U.S. National Library of Medicine, Feb. 2019, [www.ncbi.nlm.nih.gov/pmc/articles/PMC6412088/](https://www.ncbi.nlm.nih.gov/pmc/articles/PMC6412088/).
- [84] “Home.” Longevity, [www.longevity.co.uk/site/informationmatrix/senolyticstrialsandjudgements.html](https://www.longevity.co.uk/site/informationmatrix/senolyticstrialsandjudgements.html).
- [85] Jonathan R. Baker PhD, et al. “Senotherapy: A New Horizon for COPD Therapy.” Chest, Elsevier, 10 Feb. 2020, [www.sciencedirect.com/science/article/abs/pii/S001236922030252X](https://www.sciencedirect.com/science/article/abs/pii/S001236922030252X).

# **Aeronautics and Astronomy: An indirect application, in the measurement of physical parameters of Moon - Mass, Density, and Surface Gravity using the Apollo and Chandrayaan Mission's flyby/orbits data by Ivanya Kabir and Madhva Fakare**

## **Authors Biography**

Ivanya Kabir is a 12th grade science student from New Delhi, India. Her academic pursuits are driven by a desire to pursue a career in aerospace engineering. Beyond academics, Ivanya is a trained Odissi dancer and enjoys surfing and skiing.

Madhva Fakare was born and brought up in India, Mumbai. He studied physics and astrophysics at Mumbai University as an undergrad. He developed an interest in theoretical and particle physics, currently, pursuing MSc in physics from Universität Münster, Institut für Kernphysik. Beyond academics, Madhva has keen interest in reading science based novels, and listening to Indian classical music.

## **Abstract**

The Moon is an important astronomical object for Earth, and thus, studying the physical properties of the Moon, such as its mass, size, temperature, atmosphere composition, core composition, etc, is crucial. In this paper, average mass, average density, and average surface gravity are estimated using the data of the spacecrafts that visited the moon. Some of the most important moon explorations were LUNA, Apollo missions, and Chandrayaan missions. During the space race, Apollo had 14 missions, starting from 1961 to 1972, out of these 14 missions, 5 missions landed successfully on the moon. Chandrayaan has 3 missions so far, starting from 22nd October 2008. This paper will use the data of their flyby and orbital data. Kepler's third law is used to measure the moon's mass, for this, the orbital height and period are used. Using the mass of the Moon, density, and surface gravity are calculated. Standard deviations in these parameters are calculated to estimate the errors. The mass, density, and surface gravity (will be referred to as parameters in this paper), are calculated by using 5 Apollo missions data and 2 Chandrayaan missions data. The average of these parameters using the two mission data are as follows,  $M_{moon} = (7.82 \pm 2.82) \times 10^{22} kg$ ,  $\rho_{moon} = 3543.87 \pm 1362 kg/m^3$  and  $g_{moon} = 1.72 \pm 0.66 m/s^2$ .

**Keywords:** Spacecraft, Space Race, Apollo Mission, Chandrayaan Mission, Kepler Law, Mass-Density-Surface gravity of Moon.

## **Introduction**

Aeronautics is the application of science, mathematics, and engineering in flying aircraft. The science of flight has four main important components which are aerodynamics, propulsion, materials and structures, and stability and controls. (i) Aerodynamics is the study of the nature of air around the airplane, the flowing air not only provides the required lift, but it also provides a

resistive force, finding a balance between the two is crucial. The way air flows around different parts of the plane such as wings, the tail, and the main body of the aircraft, affects the motion of the plane [1]. The lift of the aircraft can be mathematically written as [2],

$$L = \frac{1}{2} * C_L * \rho * V^2 * S \dots (1)$$

L - Lift

$\rho$  - Density of the Air

V - Relative Velocity of the Air and Aircraft

S - Surface area of the wings

$C_L$  - Coefficient of the Lift

(ii) Propulsion is the study of designing the engine of the aircraft. The engine provides the required thrust to the rocket/aircraft, which is essential to generate lift. Some of the types of propulsions fuels used in rockets are liquid, solid, gas etc [3]. Thrust is the action-reaction force generated due to the burning of propulsion fuel. It can qualitatively be calculated using Newton's Third Law of Motion [4]. (iii) Materials and structures: advanced materials are required in the manufacturing of aircraft and aircraft fly in extreme situations at times, such as near space, at a speed faster than the speed of sound. The choice of material and designing the structures does not only provide strength to the aircraft but it also provides stability and safety [5]. (iv) Stability and Control: Involves handling the speed and the controls of the aircraft/rockets [6].

Aeronautics has played a crucial role in space explorations. The interplanetary journey and the moon's explorations of different planets have only been possible due to advanced aerodynamics. The Distances between planets are in millions of kilometers, for the least, the refracts requires a very high speed (for example Parker Solar Probe - 600 km/hr [7]), only possible with advanced propulsion, material-structure, aerodynamics, and aerodynamics, or advanced-aeronautics, in simple. The first successful landing mission for exploration of the moon was LUNA 2 [8], launched on the year 12th September 1959. With this, the Soviet Union became the first country to reach the moon. Before this, there were ten failed/partially successful missions executed by the U.S. and Soviet Union, in what we call today as "Space Race" [9].

The Space Race has provided a valuable source of information for the field of Astronomy. The Moon was the interest of all the countries during the space race. Missions involved were, flyby's, landing of spacecrafts on the moon, and man-landing on the moon. Information that was collected during space was planetary and lunar images, a visit to the gravitational influence of planets, the rotation rate of planets, visit to natural satellites of planets. This information was crucial, to understand the atmospheric composition, surface geography as well as the sizes of planets and their natural satellite. Interestingly, the required science that made the moon's exploration possible, and led man to land on the surface of the moon are simply (i) Newton's Laws of Motion and (ii) Aeronautics. We have already discussed aeronautics, let us discuss Newton's laws of Motion for Rockets.

## Newton's Laws of Motion

First Law of Motion: An object in motion or rest with respect to an initial frame of reference will stay in motion or rest until and unless an external unbalanced force acts on it.

Second Law of Motion: The rate of change of momentum of an object, is directly proportional to the force that is acting on the object.

Third Law: When a force acts on an object - the action, the object applies a force of the same magnitude as that of the action force, but opposite in direction - the reaction. Or in short, every action (force) has a reaction (force) equal in magnitude but opposite in direction.

### Newton's Second Law for Aircrafts

$$F = \frac{dP}{dt} \dots (2)$$

$$F = \frac{d(mv)}{dt} \dots (3)$$

$$F = m \frac{dv}{dt} = ma \dots (4)$$

The required acceleration is produced by the applied force on the aircraft, and the applied force on the aircraft is a reaction of the wind turbine's rotation and emission of fast moving air in the opposite direction of its motion. The lift on the other hand is produced due to air pressure differences on the upper and lower part of the wings, a result of Bernoulli's Theorem [10].

$$P_1 + \rho gh_1 + \frac{1}{2}\rho v_1^2 = P_2 + \rho gh_2 + \frac{1}{2}\rho v_2^2 \dots (5)$$

$P_1$  - Pressure in the lower side of the wings

$P_2$  - Pressure in the upper side of the wings

$v_1$  - velocity of air in the lower side of the wings

$v_2$  - velocity of the air in the upper side of the wings

$h_1$  - Height of the lower wings from the ground

$h_2$  - Height of the upper wings from the ground

$\rho$  - Density of Air

$g$  - acceleration due to gravity

For aircraft,  $h_1 = h_2$ , thus, the simplified form is,

$$P_1 + \frac{1}{2}\rho v_1^2 = P_2 + \frac{1}{2}\rho v_2^2 \dots (6)$$

Rearranging equation no. 6, we get,

$$P_1 = P_2 + \frac{1}{2}\rho(v_2^2 - v_1^2) \dots (7)$$

The air on the lower part of the wings has lower velocity compared to the upper part of the wings, due to its geometrical shape, this creates a pressure difference between the lower and upper arm. The air in the lower part of the wings has high pressure thus creating a force in the upward direction, and generating lift. As  $v_2$  is greater than  $v_1$ , this makes  $P_1$  greater than  $P_2$ .



Thus, the magnitude of lift on the aircraft is equal to  $f_{lift} = (P_1 - P_2) * S \dots (8)$ , where S is the surface area of the wings.

### For Rockets

Rockets are different from aircraft in many ways.

- (i) they do not have a wind turbine for producing thrust
- (ii) rockets are shot vertically upward, that is perpendicular to the earth's surface, whereas, aircraft are launched parallel to the ground
- (iii) rockets need to move tremendously faster, about 10 to 15 km per second, to break earth's gravitational field. The third reason is the most significant one. Newton's second law of motion for rockets:

$$F = \frac{d(mv)}{dt} \dots (\text{from equation 3})$$

$$F = m \frac{dv}{dt} + v \frac{dm}{dt} \dots (9)$$

$$F = ma + v \frac{dm}{dt} \dots (10)$$

Using,  $\frac{dv}{dt} = a$ . Equation 10. is Newton's second law of motion for rockets. The second term of equation 10, is used to produce thrust in rockets. Rocket works by burning fuels and emitting the gasses in the direction towards ground, thus producing the thrust in the vertically upward direction.

$$\Delta v = u \ln\left(\frac{m_i}{m}\right) - g \Delta t \dots (11)$$

$\Delta v$  - velocity after time  $\Delta t$

u - initial velocity of the rocket

m - mass of the rocket

$m_i$  - initial mass of the rocket

The velocity of the rocket keeps on increasing as a function of the emission of burned glass from the rocket's exhaust. The velocity of the rocket as a function of time is given by the equation 11[11]. This is all the required scientific theoretical tools required to put man on the moon. In this paper, we will be using the data from the Apollo and Chandrayaan missions to calculate the physical parameters of the Moon. We will be calculating the mass, density, and acceleration due to gravity of the Moon in this paper. We will use Kepler's third law of motion. Kepler's third law of motion can be derived as Consider this model, let the spacecraft enter the Moon, rotate in the moon's orbit at an altitude of 'H', and take a period 'T' to complete a single revolution about the Moon at an altitude of h. Also, let the radius of the Moon be R. The gravitational force on the spacecraft due to the Moon is [12]:

$$F_{gravitation} = \frac{GM_{moon} M_{spacecraft}}{(R + H)^2} \dots (12)$$

where,

$F_{gravitation}$  - Force of Gravity on Spacecraft

$M_{moon}$  - Mass of Moon

$M_{spacecraft}$  - Mass of Spacecraft

G - Universal constant of Gravitation

R - Radius of Moon

H - Altitude of the Spacecraft

The centripetal force on the spacecraft at an altitude of 'H' is given by:

$$F_{centripetal} = M_{spacecraft}(R + H)\omega^2 \dots (13)$$

where  $\omega$  is the angular velocity of the spacecraft at an altitude H.

$$F_{centripetal} = 2\pi M_{spacecraft}(R + H)/T \dots (14)$$

using,  $\omega = \frac{2\pi}{T}$ , in equation (14). The provided centripetal force is by the gravitational attraction of the moon. Equating, equation (12) with (14).

$$GM_{moon} M_{spacecraft}/(R + H)^2 = 4\pi^2 M_{spacecraft}(R + H)/T^2 \dots (15)$$

Canceling, the mass of the moon  $M_{moon}$  from both sides of the above equation, we get,

$$(R + H)^3/T^2 = GM_{moon}/4\pi^2 \dots (16)$$

Rearranging the equation no 16, we get,

$$M_{moon} = 4\pi^2(R + H)^3/GT^2 \dots (17)$$

We can calculate the mass of the Moon ' $M_{moon}$ ' by knowing the orbital period and altitude of the spacecraft. Once we have the mass of the moon, we can calculate the average density of the moon, by using:

$$\rho_{moon} = M_{moon}/(\frac{4}{3}\pi R^3) \dots (18)$$

and, acceleration on the surface of moon by using:

$$g_{moon} = GM_{moon}/R^2 \dots (19)$$

In this paper, we will calculate the mass, density, and acceleration due to gravity on the surface (collectively will be called "parameters") using equations 17, 18, and 19.

## Methodology

This section discusses the methodology used to conduct the research.

## Aim of the study

To determine the physical parameters of the Moon such as its mass, density, and surface gravity

## Research design

In this study, the orbital period and distance of spacecraft such as Apollo Lunar Module and Chandrayaan Lunar Module in the lunar orbit is recorded. With the application of Kepler's third law of motion (17), we will calculate the mass of the Moon. The density and surface gravity can be calculated once the mass of the Moon is known, using equations 18 and 19.

### Tools Used

Classical Mechanics, Kepler's Laws of Planetary Motion, Python

### Data Collection Procedure

The data is collected for Apollo Missions 11,12, 14, 15, and 16 and Chandrayaan Mission 1, and 3.

### Result

#### *Apollo Mission*

The Apollo mission started with a commitment of President John F. Kennedy to the United States to send men to the Moon by 1970. It was the first attempt of mankind to send humans to the moon. There were a total of 12 Apollo missions. Apollo 1, 7, 8, 9, 10, 11, 12, 13, 14, 15, 16, 17. The missions took place from 1st January 1967 to 19th December 1972. Out of these missions, Apollo 1 and 13 were not successful and unfortunately, turned out to be disastrous accidents. Apollo 7 and 9 were missions to test the command and lunar modules by revolving around Earth and never actually made it to the Moon. The useful data is from Apollo 8, 11, 14, 15, and 16, which we will use in this paper. Apollo 10 and 17 have highly eccentric orbits [13].

The orbital period of the spacecraft is a function of the altitude of the spacecraft from the surface of the Moon. The lower the altitude, higher would be their orbital velocity, thus lower would be their orbital period. The orbital time period is the time required for the spacecraft to complete one complete revolution about the Moon. The Altitude of the spacecraft is the height of the spacecraft from the surface of the Moon. The Orbital time period and height of the spacecraft for different Apollo and Chandrayaan Missions are given in the table number 1 and 3.

Sr. No.	Apollo Mission	Orbital Time Period (Minutes )	Height from the surface of Moon - major axis(Km)
1	08	120.00 [14]	265.00 [14]
2	11	120.00 [15]	223.30 [15]

3	14	88.18[16]	317.49[16]
4	15	120.00 [17]	241.00 [17]
5	16	120.00 [18]	220.00 [18]

Table 1: Orbital period and altitudes of the Apollo mission's lunar module.

The parameters are calculated by following the below steps, mainly four steps.

**Step 1: Determination of Mass**

To calculate the mass of the moon, Kepler's third law is used (equation 17). The mass is calculated using the orbital time period and distance of the spacecraft from the center of the moon. In Table no 1, the major-axis distances of the spacecraft for different missions are provided, the altitude of the spacecraft is half of the major distance, that is, equal to the semi-major distance.

*Step 2: Determination of Density*

Using the mass calculated in step 1, the density is calculated using the equation 18. The density is calculated for each mission.

*Step 3: Determination of Surface Gravity*

Using the mass calculated in Step 1, the gravity on the moon near the surface is calculated using Equation 19.

*Step 4: Estimation of Error*

Due to the unavailability of the error details in the measurement of the orbital time and distance parameters, errors cannot be calculated using the error formula. Instead, the standard deviation is been calculated, which is defined as [19]:

$$\sigma = \sqrt{\frac{\sum(x_i - \mu)^2}{N}} \dots (20)$$

where,  $x_i$  - data points

$\mu$  - average of the data points

$N$  - total number of data points

$\sigma$  - standard deviation

A simple Python code, provided below, is used to carry all the above four steps for Apollo data.

*Python Code 1:*

```
# importing modules
import matplotlib.pyplot as plt
import numpy as np
```

```

# defining constant
# radius of moon, in meters.
r = 1.740*10**6
# universal constant of gravity, in Nm**2/kg**2
g = 6.67*10**-11

# defining the data of apollo 8, 11, 14, 15, 16
# orbital time period
time = [120, 119, 88.18, 120, 120]
# apogee + perigee distance
height = [2.65*10**5, 2.233*10**5, 3.211*10**5, 2.4100*10**5, 2.2000*10**5]
# distance of the moon from the center of the earth will be equal to
# the height plus the radius of the moon
# this is also the semi-major distance of the spacecraft.
# dummy list
distance = [0, 0, 0, 0, 0]
# dummy mass list
mass = [0, 0, 0, 0, 0]
# defining dummy density
density = [0, 0, 0, 0, 0]
# gravity on the surface of moon
gravity = [0, 0, 0, 0, 0]

# finding the distance from the center of the moon
for i in range(0, 5):
    # height is the average distance of apogee and perigee
    distance[i] = height[i]/2 + r

# defining the mass function
def mass_function(x, y):
    # x is the orbital time period in min
    # y is the semi-major axis in m
    m = (4*np.pi**2*y**3)/(g*(x*60)**2)
    return m

# calling the mass function
for i in range(0, 5):
    mass[i] = mass_function(time[i], distance[i])

```

```

# calculating the density of moon
# density of moon, in kg/m**3
def den(z):
    return z/((4/3)*np.pi*r**3)

# calculating the surface gravity of moon
# surface gravity in m/s**2
def grav(k):
    return (g*k)/r**2

for i in range(0, 5):
    density[i] = den(mass[i])
    gravity[i] = grav(mass[i])

mass_avg = np.average(mass)
density_avg = np.average(density)
gravity_avg = np.average(gravity)

# Error Formula
mass_error = np.std(mass)
density_error = np.std(density)
gravity_error = np.std(gravity)

```

The output is tabulated in table no 2.

Sr. No.	Apollo Mission	Mass of Moon (e22)	Density of Moon (Kg/m <sup>3</sup> )	Surface Gravity (m/s <sup>2</sup> )
1	08	7.4960	3397.01	1.6514
2	11	7.3707	3340.24	1.6238
3	14	14.515	6577.98	3.1978
4	15	7.3528	3332.12	1.6198
5	16	7.2290	3276.02	1.592

Table 2: Mass of Moon calculations from Apollo Missions data - Output of Python Code 1

From the above table, we can see that the parameters of the moon are in the range of  $[7, 15] \times 10^{22} kg$ ,  $[3200, 6600] kg/m^3$ , and  $[1.5, 3.2] m/s^2$ . The errors in these parameters are the standard deviations of these parameters calculated using Equation 20. The errors in the parameters are  $2.68 \times 10^{22} kg$ ,  $1297 kg/m^3$ , and  $0.63 m/s^2$ . The average and errors of these parameters are calculated using Python Code 1, the output of which could be generated in a structured order by adding a few additional lines of code to code no 1.

*Python Code 2:*

# Adding a few extra lines of code in code 1, to print the calculations in the most standard form

```
print("The Mass of the Moon: " + str(mass_avg) + " [ /- ] " + str(mass_error))
print("The Density of the Moon: " + str(density_avg) + " [ /- ] " + str(density_error))
print("The Gravity of the Moon: " + str(gravity_avg) + " [ /- ] " + str(gravity_error))
```

The output is shown below

The Mass, Density, and Gravity of the Moon are  $[ 8.79 \pm 2.68 ] * 10^{22} kg$ ,  $3984.68 \pm 1297 kg/m^3$ , and  $1.93 \pm 0.63 m/s^2$ , respectively.

### ***Chandrayaan Missions***

Chandrayaan is India's first lunar mission for scientific exploration. Under the Chandrayaan mission, three distinct missions, namely Chandrayaan 1, Chandrayaan 2, and Chandrayaan 3 were planned. Chandrayaan -1 was launched from the southern part of India, Sriharikota on October 22, 2008, whereas Chandrayaan 3 was launched on 14th July 2023, specifically designed to land on the south pole of the moon [20]. The lunar orbital data of Chandrayaan 1 and 3 are provided in Table no 3.

Sr. No.	Chandrayaan Mission	Orbital Time Period (minutes)	Height from the surface of the Moon - major axis(Km)
1	01	136	442
2	03	126	300

Table 3: Orbital period and altitudes of Chandrayaan mission's lunar module.

The four steps that were carried out on the data of Apollo missions, which are, Step 1 - Determination of Mass, Step 2 - Determination of Density, Step 3 - Determination of Surface Gravity, and Step 4 - Estimation of Error, are carried out for Chandrayaan's data. The Python code provided in code 1, can be used to perform the steps. The output is provided below, in table no 4.

Sr. No.	Chandrayaan Mission	Mass of Moon (e22)	Density of Moon (Kg/m <sup>3</sup> )	Surface Gravity (m/s <sup>2</sup> )
1	1	6.7032	3037.73	1.4767
2	3	6.9915	3168.39	1.5402

Table 4: Mass of Moon calculations from Apollo Missions data - Output of Python Code 1

The error profile can be calculated using Python Code 2, the output is mentioned below. The Mass, Density, and Gravity of the Moon are  $[6.84 \pm 0.144] * 10^{22} \text{ kg}$ ,  $3103.06 \pm 65 \text{ kg/m}^3$ , and  $1.51 \pm 0.031 \text{ m/s}^2$ , respectively. The calculations of the parameters of the moon from both the Apollo and Chandrayaan missions are summarized in Table 5.

Missions	Mass (e22 Kg)	Density (Kg/m <sup>3</sup> )	Surface Gravity (m/s <sup>2</sup> )
Apollo	$8.79 \pm 2.68$	$3984.68 \pm 1297$	$1.93 \pm 0.63$
Chandrayaan	$6.84 \pm 0.144$	$3103.06 \pm 65$	$1.51 \pm 0.03$
Average Moon	$7.82 \pm 2.82$	$3543.87 \pm 1362$	$1.72 \pm 0.66$
Average Earth	597 [21]	5514 [22]	9.81 [23]
Ratio(Earth/Moon)	76.34	1.55	5.7

Table 5: - Parameter calculations for Apollo and Chandrayaan Missions

Moon is the natural satellite of Earth, present at a distance of 384,400 km. The Moon is smaller in mass than Earth by about 76 times, hence, Moon and Earth are not comparable in mass, and their order of magnitude of mass differs by a factor of about 100. This is also why the Moon is the natural satellite of Earth and not otherwise. Even Though the moon is about 76 times



less massive than Earth, its density is only about 1.5 times less than Earth, hence, the Earth and the Moon have comparable densities, this is also true because both Moon and Earth are terrestrial astronomical objects. The surface gravity on the moon is about 6 times weaker than that on Earth, this is a major reason why there is no atmosphere on the Moon.

## **Conclusion**

Advancement in aeronautics has led man to the moon, exploration of the moon is done in many missions, including Apollo, Chandrayaan, LUNA missions, etc. The purpose of these missions was to study the Moon and to understand its scientific properties and similarities. The Moon controls many phenomena on Earth, such as tides, balances the spin of Earth on its axis etc. Which results in geographical and climatic changes on Earth. In this paper, we have calculated three physical parameters of the Moon which are, mass, density, and surface gravity. We used Kepler's third law of motion to estimate the mass of the moon and using the mass we calculated the density and surface gravity. It is important to note, that while calculating the parameters of the moon, the physical parameters of the spaceship that was in the orbit of the moon had no significance in the calculation, such as its mass, volume, density, etc.

In this paper, data from two missions was used, the Apollo mission and the Chandrayaan mission. In the Apollo mission, data from five sub-missions was used, the mission that successfully entered the moon's orbit. The second mission is the Chandrayaan mission, it has a total of three sub-missions namely, Chandrayaan-1, Chandrayaan-2, and Chandrayaan 3. Out of which, in this paper, only the data of Chandrayaan-1 and Chandrayaan-3 was used due to their availability. The calculations can be summed up into four steps, namely,

Step 1 - Determination of Mass

Step 2 - Determination of Density

Step 3 - Determination of Surface Gravity

Step 4 - Estimation of Error.

The measurement of these parameters is summarized in Table no 5. We can see that the calculations have fewer errors for Chandrayaan than for Apollo missions, this may be because (i) due to fewer data points in the Chandrayaan missions(a mere coincidence, and not correlated), (ii) both missions, Chandrayaan 1 and 3 inclines their orbit at 18 and 27 degree, respectively, which are lower than Apollo missions about 32 degree. Thus, the moon exploration missions provide us with valuable data to measure the parameters of the moon.

## Works Cited

- [1] *Aeronautics*. [www.grc.nasa.gov/www/k-12/UEET/StudentSite/aeronautics.html](http://www.grc.nasa.gov/www/k-12/UEET/StudentSite/aeronautics.html).
- [2] *Aerodynamics of flight*. [www.faa.gov/sites/faa.gov/files/07\\_phak\\_ch5\\_0.pdf](http://www.faa.gov/sites/faa.gov/files/07_phak_ch5_0.pdf).
- [3] Baperry, Author. *Rocket Fuel – Rocketology: NASA’s Space Launch System*. 21 Apr. 2016, [blogs.nasa.gov/Rocketology/tag/rocket-fuel](http://blogs.nasa.gov/Rocketology/tag/rocket-fuel).
- [4] NASA Glenn Research Center. “What Is Thrust? | Glenn Research Center | NASA.” *Glenn Research Center | NASA*, 21 July 2022, [www1.grc.nasa.gov/beginners-guide-to-aeronautics/what-is-thrust/#:~:text=Thrust%20is%20generated%20by%20the,accelerating%20a%20mass%20of%20gas](http://www1.grc.nasa.gov/beginners-guide-to-aeronautics/what-is-thrust/#:~:text=Thrust%20is%20generated%20by%20the,accelerating%20a%20mass%20of%20gas).
- [5] NASA Glenn Research Center. “Rocket Parts | Glenn Research Center | NASA.” *Glenn Research Center | NASA*, 20 Nov. 2023, [www1.grc.nasa.gov/beginners-guide-to-aeronautics/rocket-parts](http://www1.grc.nasa.gov/beginners-guide-to-aeronautics/rocket-parts).
- [6] “Rocket Stability | Glenn Research Center | NASA.” *Glenn Research Center | NASA*, 20 Nov. 2023, [www1.grc.nasa.gov/beginners-guide-to-aeronautics/rocket-stability/#:~:text=If%20the%20rocket%20wobbles%2C%20or,adding%20weight%20to%20the%20nose](http://www1.grc.nasa.gov/beginners-guide-to-aeronautics/rocket-stability/#:~:text=If%20the%20rocket%20wobbles%2C%20or,adding%20weight%20to%20the%20nose).
- [7] Ward, Cassidy. “The Parker Solar Probe Sets New Record for Fastest Spacecraft.” *SYFY Official Site*, 10 Oct. 2023, [www.syfy.com/syfy-wire/the-parker-solar-probe-sets-new-record-for-fastest-spacecraft#:~:text=On%20its%20last%20three%20orbits,\(430%2C000%20miles%20per%20hour\)](http://www.syfy.com/syfy-wire/the-parker-solar-probe-sets-new-record-for-fastest-spacecraft#:~:text=On%20its%20last%20three%20orbits,(430%2C000%20miles%20per%20hour)).
- [8] Mars, Kelli. “60 Years Ago: Luna 2 Makes Impact in Moon Race - NASA.” *NASA*, 23 Aug. 2023, [www.nasa.gov/history/60-years-ago-luna-2-makes-impact-in-moon-race](http://www.nasa.gov/history/60-years-ago-luna-2-makes-impact-in-moon-race).
- [9] “What Was the Space Race?” *National Air and Space Museum*, 23 Aug. 2023, [airandspace.si.edu/stories/editorial/what-was-space-race](http://airandspace.si.edu/stories/editorial/what-was-space-race).
- [10] Dasgupta, P. “Reconstructions of Paleohydraulic Conditions From Primary Sedimentary Structures.” *Elsevier eBooks*, 2017, pp. 63–84. <https://doi.org/10.1016/b978-0-12-803386-9.00005-8>.
- [11] OpenStax. *9.7 Rocket Propulsion | University Physics Volume 1*. [courses.lumenlearning.com/suny-osuniversityphysics/chapter/9-7-rocket-propulsion/#:~:text=mim](http://courses.lumenlearning.com/suny-osuniversityphysics/chapter/9-7-rocket-propulsion/#:~:text=mim).
- [12] *Orbits and Kepler’s Laws - NASA Science Kepler’s Laws*. [science.nasa.gov/solar-system/orbits-and-keplers-laws](http://science.nasa.gov/solar-system/orbits-and-keplers-laws).
- [13] “<https://www.nasa.gov/wp-content/uploads/static/apollo50th/NASA: Apollo 50th Anniversary>.” <https://www.nasa.gov/wp-content/uploads/static/apollo50th/NASA, www.nasa.gov/specials/apollo50th/missions.html#:~:text=Apollo%20program%20%E2%80%A2%20The%20Apollo,Moon%20from%201968%20to%201972>.
- [14] *Apollo 8*. [nssdc.gsfc.nasa.gov/nmc/spacecraft/display.action?id=1968-118A#:~:text=The%20spacecraft%20was%20launched%20on.an%20inclination%20of%2032.51%20degrees](http://nssdc.gsfc.nasa.gov/nmc/spacecraft/display.action?id=1968-118A#:~:text=The%20spacecraft%20was%20launched%20on.an%20inclination%20of%2032.51%20degrees).

- [15] *Apollo Program* | *National Air and Space Museum*.  
[airandspace.si.edu/explore/topics/spaceflight/apollo-program](http://airandspace.si.edu/explore/topics/spaceflight/apollo-program).
- [16] Contributors to National Aeronautics and Space Administration Wiki. “Apollo 14.”  
*National Aeronautics and Space Administration Wiki*,  
[nasa.fandom.com/wiki/Apollo\\_14#:~:text=Mission%20parameters,-Geocentric%3A&text=Perigee%3A%20183.2%20km,Orbital%20period%3A%2088.18%20min](http://nasa.fandom.com/wiki/Apollo_14#:~:text=Mission%20parameters,-Geocentric%3A&text=Perigee%3A%20183.2%20km,Orbital%20period%3A%2088.18%20min).
- [17] *Apollo 15*.  
[nssdc.gsfc.nasa.gov/nmc/spacecraft/display.action?id=1971-063D#:~:text=The%20orbital%20period%20was%20approximately,rapidly%20altered%20by%20gravitational%20perturbations](http://nssdc.gsfc.nasa.gov/nmc/spacecraft/display.action?id=1971-063D#:~:text=The%20orbital%20period%20was%20approximately,rapidly%20altered%20by%20gravitational%20perturbations).
- [18] *Apollo 16*.  
[nssdc.gsfc.nasa.gov/nmc/spacecraft/display.action?id=1972-031D#:~:text=The%20initial%20periselene%20was%2090,clockwise%20as%20viewed%20from%20north](http://nssdc.gsfc.nasa.gov/nmc/spacecraft/display.action?id=1972-031D#:~:text=The%20initial%20periselene%20was%2090,clockwise%20as%20viewed%20from%20north).
- [19] “2. Mean and Standard Deviation | the BMJ.” *The BMJ* | *the BMJ: Leading General Medical Journal. Research. Education. Comment*, 28 Oct. 2020,  
[www.bmj.com/about-bmj/resources-readers/publications/statistics-square-one/2-mean-and-standard-deviation](http://www.bmj.com/about-bmj/resources-readers/publications/statistics-square-one/2-mean-and-standard-deviation).
- [20] *Indian Space Research Organisation*. [www.isro.gov.in](http://www.isro.gov.in).
- [21] *Earth Fact Sheet*. [nssdc.gsfc.nasa.gov/planetary/factsheet/earthfact.html](http://nssdc.gsfc.nasa.gov/planetary/factsheet/earthfact.html).
- [22] Earthhow. “Density of Earth: What Is the Earth Made Of?” *Earth How*, 24 Sept. 2023,  
[earthhow.com/density-of-earth](http://earthhow.com/density-of-earth).
- [23] *The Value of G*. [www.physicsclassroom.com/class/circles/Lesson-3/The-Value-of-g](http://www.physicsclassroom.com/class/circles/Lesson-3/The-Value-of-g).

# **The Evolution of Stigma as it Relates to OCD and Suggestions for Stigma Reduction in the Future By Noah Kang**

## **Abstract**

This review expands on the stigmatic behavior towards Obsessive Compulsive Disorder, a chronic disorder with serious impairments in relation to compulsions and intrusive thoughts. It covers various attributes such as the historical context of the disorder, the historical context of its stigma, the general overview of its stigma, its evolution of stigma, its stigma in various contexts such as in differing ethnic groups, and modern day stigma. Additionally, the review delves deep into the future implications of stigmatic behavior towards OCD, and how to decrease it using different mediums such as technological apps and curated programs. When analyzing the disorder's stigmatic behavior in multiple facets, numerous findings arose. "Taboo" symptoms of OCD were seemingly much more stigmatized within communities, mainly consisting of violent or sexual content. Currently in modern day, OCD has overtaken social media, as an analysis on TikTok revealed that social media often trivializes OCD, diminishing its seriousness and increasing its stigma. Lastly, the review explores possible alleviations for OCD's stigma. For instance, the OCD literacy app esTOCma has been showing promising effects on its benefits for increasing OCD comprehension in educational settings. With possible solutions to OCD's stigmatization being developed, there is still much data and analysis that remains to be conducted within its field. Thus, OCD needs to be further studied in a longitudinal and regional setting to reach more conclusive methods of its destigmatization.

## **Introduction**

Obsessive-compulsive disorder (OCD) is a chronic disorder with serious impairment, such as interpersonal dysfunction or interference with obtaining medical treatment due to fears of contamination (Stein et al.; Veale and Roberts). OCD entails obsessive thoughts, inducing compulsions that often restrict the lives of sufferers and cause relational impairment. These obsessive thoughts can range widely, and can include violent or sexual content that would often be considered taboo by the general public. As a result of obsessions, sufferers may perform compulsions in order to decrease associated anxiety, such as a series of checking behaviors to reassure themselves that their obsessive thought had not actually occurred (Fennel and Liberato, 306).

OCD is ranked by the World Health Organization as one of the top ten most life-impeding conditions, as it is also the fourth most common mental disorder after depression, alcohol/substance misuse, and social phobia (Veale and Roberts). Despite it being so common, OCD is heavily stigmatized within society, due to its aforementioned "taboo" nature of obsessions and associated odd behaviors (McCarty et al.). Whether it be in work spaces or even clinical settings, OCD sufferers frequently face rejection (Wenzke; Steinberg and Wetterneck). Considering the magnitude of how impairing OCD stigma can be in an individual's life, as well as how common it is, this paper synthesizes research on the development of OCD stigma,

suggests recommendations for future research, and proposes possible solutions to alleviate OCD stigma. Doing so is crucial, since reducing stigma helps more OCD sufferers get treatment (Glazier et al., 1).

It is important to note that OCD is a spectrum with varying intensities, differing presentations and distinct alternatives (Guazzini). For example, traditional presentations of OCD involve checking, repetitive action, counting, collecting and washing (Guazzini). However, OCD obsessions have developed over the past years to include novel content, such as obsessions regarding social media (Guazzini). The heterogeneity of OCD can result in unique and varied stigmatizations. Thus, obsessive-compulsive disorder's varied presentation, impairment, stigmatization, and frequency within populations frame it as a field of study requiring abundant research. Therefore, this paper will address the following: The history of OCD, stigma and its evolution as it relates to OCD in the United States and cross-culturally, and final implications regarding future research for reducing or understanding OCD stigma.

### **Historical Context of OCD**

Numerous historians and psychologists believed that certain theologians back in the 15th century, such as Martin Luther, John Bunyan and Ignatius Loyola, showcased symptoms of "religious scrupulosity," a unique variation of Obsessive Compulsive Disorder (Cefalu). This trend of OCD manifesting in religiosity is further supported by Professor Lennard J. Davis, who argues that OCD actually originated from paranoia caused by religious notions such as demons, before evolving into a medical condition (Davis). Unfortunately, there is not enough data about these niche fields of study in OCD. However, the historical background of OCD became more accessible starting from the 19th century. The first official medical reports published about OCD occurred in the late 1800s, as they were initially viewed as a form of psychosis that stemmed from paranoia. In 1877, the German psychiatrist Carl Wetsphal was the first to suggest that OCD is a mental illness. This conceptualization would remain until modern day. Despite this, several questions remained about the mental illness. What specific classifications should it possess? Did it fall under the category of neurasthenia, a vague medical condition that was associated with mental fatigue? Or did it adhere more to the degeneration theory, a concept that suggested the decline of mental steadiness among generations? With debates surrounding the illness, significant psychological figures such as Sigmund Freud weighed in. Freud considered OCD to be a state of neurosis based on paranoia; his nosological considerations would be generally rejected. Additionally, many arguments appeared regarding OCD and the extent of its compulsiveness, which is an ongoing argument to this day. As a result of all these diverse ideas, many incorrect assumptions and theories were associated with OCD (Oberbeck).

### **History of Stigma in OCD**

The historical significance of OCD also includes the history of its stigma. Although there has not been extensive research done on this niche topic, the perception of sufferers of mental disorders as weird or unwelcome in society has a long history, and this has evolved with the

changing perceptions of mental health. The term “stigma” originated from the Ancient Greeks, who used it to represent those that were “peculiar” or “inferior.” Throughout history, this term would be adapted into many cultural and religious domains, such as Christianity, and would eventually be formally defined in scientific literature by scientist Erving Goffman. Thus, stigma would be defined as the negative perception of people with “abnormal” characteristics. In the past, stigma was considered to be influenced by a variety of historically-defined attributes: the distinction of “mental personalities” (including mental disorders, homosexuality, addictions), “physical disabilities” (unemployment, suicide attempts), and the ethnological differences of populations (e.g. race, nationality, etc) (Akyurek, et al.). Additionally, stigma would prove to be highly significant during times of disease and plague. For instance, during the 15th century in Europe when syphilis was spreading, people who contracted the disease were cursed for centuries. Similarly, AIDS was considered by many a “divine punishment” from God towards those that have sinned (Akyurek, et al.).

Levels of stigma in mental health fluctuated through history rather than improving linearly. During the Enlightenment Era in the late 17th and 18th centuries, mental health was acknowledged and attempts were made to treat it. However, during other epochs of history such as the Middle Ages, mentally ill people were killed and enslaved. During World War II, the Nazis executed thousands of mentally ill people, as stigma during that time in Germany was extremely severe for those who were diagnosed with mental disorders (Rössler, 2016).

Once again, the research regarding OCD stigma and its historical context is a field of study that has not been extensively researched. As a result, information gained from this body of research is ambiguous and incomplete. It can be surmised that the history of stigma in OCD followed a similarly fluctuating pattern as that of general mental illness.

### **OCD Stigma**

Stigma regarding mental health is generally divided into four components: public stigma, self-stigma, label avoidance, and structural stigma (Corrigan and Blink). Public stigma is the general population's negative perception of people with mental illnesses and their stigmatized behavior, which can lead to discrimination (Corrigan and Blink). In OCD, people who have more taboo content in their obsessive thoughts (e.g., violent or sexual content) generally face more public stigmatization (McCarty et al.). Self-stigma is the internalized stigmatization of people who have mental health issues. People often form self-stigma because of three factors: their acknowledgment of mental illness stereotypes, their personal agreement with these stereotypes, and their acceptance of these stereotypes. Self-stigma makes mental health patients prone to further internal degradation and shame, which can lead to numerous consequences, including avoidance in seeking treatment, which worsens their conditions overtime (McCarty et al.). Label avoidance is a stigmatic behavior that is similar to the consequences of self-stigma, where patients will try to minimize contact with any medical help regarding their disorder to avoid acquiring labels for their condition (McCarty et al.). For example, a patient with OCD may not seek help because they simply do not want to be seen leaving a psychiatric hospital. Although

this may seem similar to the consequences of self-stigma, there is a key difference between the two. Label avoidance happens in order to avoid labels relating to mental illness, while self-stigmatic behaviors stem from the shame patients internalize from public stigmatization (Corrigan and Blink). Structural stigma occurs when stigmatic policies are adopted that can discriminate and marginalize those with mental disorders. For instance, the policy of restricting parental rights for people who have a past history of mental illness could marginalize mentally ill people based on assumptions the government makes of their medical history (Corrigan and Blink).

Overall, the stigmatization of mental illness curates a negative perception of sufferers that can potentially worsen their symptoms by shaming them away from seeking treatment and help. This is especially relevant for OCD patients that show stigmatized symptoms—such as violent obsessions—and is an important consideration for the treatment of this common disorder.

### **How Stigma Has Evolved in OCD**

Mental health stigma has evolved rapidly in the past years. A study that analyzed the evolution of mental health stigma over the course of 25 years starting in the 1990s revealed mixed conclusions (Schomerus and Angermeyer). Although the data indicates that psychiatric treatments that occur in hospital or office settings have become more accepted as of 2016 than 25 years prior, enthusiasm seemed to be decreasing. Additionally, the data also suggested that certain mental illnesses such as schizophrenia were shown to be even more stigmatized in the early 2000s compared to earlier years (Schomerus and Angermeyer).

In 2003, a study was conducted among 113 students that asked them to judge three OCD compulsions: harming, washing, and checking (Simonds and Thorpe). They were asked to evaluate the constructs of fear, shame and social acceptance in context with the described compulsions. As expected, harming compulsory actions were deemed the most unacceptable, followed by washing and then checking habits. However, despite a clear trend emerging, possible confounds may have influenced the results and more research is required to determine whether this pattern holds.

The trend of the most “taboo” components of OCD being faced with the most stigma remained prevalent in 2016, when a study among 738 adults across America were randomly assigned a vignette with one of the following obsessions: contamination, symmetry, taboo content, and harm (McCarty et al.). Similarly to the 2003 data, the participants that were assigned the vignettes of taboo content and harm exhibited the most stigmatic attitude (McCarty et al.). This shows that the evolution of stigma in OCD based on these respective categories for the most part has remained stable over the past 20 years. However, this raises a question on how these negative perceptions of the public affect the self-stigma of OCD sufferers, especially those that suffer with taboo obsessions.

OCD sufferers who battle with taboo thoughts such as harming a child often face self-stigma and shame, making them reluctant to tell medical professionals due to their fear of public stigma or judgment (Glazier et al., 1). A survey conducted among 3,109 students in 2015

asked questions regarding barriers to treatment, including the influences of self-stigma, worry regarding the opinions of others, different approaches used to handle OCD among individuals, and logistical factors that could potentially affect whether or not OCD sufferers could get treatment. The results were unfortunate: the majority of responders diagnosed with OCD faced a large medical barrier due to shame and stigma, while an even greater majority expressed their fear of being put in a psychiatric hospital against their own will (Glazier et al., 3). This is replicated in a cross-sectional study of 112 OCD patients in 2020 (Ansari et al.). In this study, each patient's habits in medical adherence were evaluated in comparison with their self-stigma levels using the Yale-Brown scale, which measures the severity of OCD symptoms (Ansari et al.). This study revealed that self-stigma reduced medical adherence among patients, while the severity of OCD symptoms also had the potential to increase self-stigma, further reducing medical adherence (Ansari et al.).

The effects of self-stigma among OCD sufferers are further elaborated in a study from 2017 which revealed self-stigma's negative effects on interpersonal relationships and daily well being (Picco). Hence, the negative effects of self-stigma among OCD patients and its consequences in medical and social settings have remained relatively similar in studies across the last 20 years.

The role of mental health literacy and recognition also influences self-stigma. According to research conducted in 2009, the lack of recognition for anxiety conditions could potentially lead to lower levels of seeking help (Cole and Coleman). This was implied in a study from 2016 as well, where a cross-sectional survey showed a decrease in internal stigma for OCD sufferers when they could properly understand their mental illness. Theoretically, a decrease in internal stigma could prompt greater adherence to medical services and medication (Picco).

Altogether, the available data suggests that OCD stigma has remained stable over the last 20 years. The stigmatization regarding OCD is still very prominent within many communities as well as being common within households. For instance, many families with stigmatized attitudes often "conceal" the OCD from their family as a coping mechanism to counteract their shame (Stengler-Wenzke).

The evolution of OCD stigma is something that remains under-researched and clear patterns have not yet emerged. However, we can conclude from changes of OCD stigma over time that numerous influences affect certain aspects of OCD stigma. For example, increased understanding of OCD tends to decrease stigma, as shown by research regarding the self-comprehension of individuals and their self-stigma, which revealed internal stigma to be lowered when an OCD sufferer understands their condition (Abdin).

### **Stigma in Various Ethnic Groups**

According to a study consisting of 428 participants from 13 different countries in North America, Western Europe and South Asia, there are numerous cross-cultural differences regarding the perception of OCD and its treatments. For instance, East Asian participants were more likely than North Americans and Western Europeans to stigmatize OCD by claiming it to



be the sufferer's fault, as well as discouraging sufferers from seeking treatment. Additionally, East Asian participants were also more likely to suggest pseudoscientific solutions such as acupuncture and herbal medicine compared to the evidence-based methods of treatment, which stems from their beliefs about the relationship between the supernatural and mental health. On the other hand, Western countries favored traditional clinical psychological treatments (Yang et al.).

A similar finding is emphasized in a study analyzing the Asian perception of mental illnesses (Lauber and Rössler). Analyses revealed that East Asian societal and cultural beliefs tend to lead to stigmatization. For instance, being mentally ill is considered "socially disadvantageous" in Eastern cultures, as it is also associated with danger and aggression. Additionally, the family hierarchy within Eastern cultures often leads to family members who are mentally ill being shunned (Lauber and Rössler). Another study that observed the behavior of different ethnic groups when it came to OCD revealed that ethnic minorities were more likely to take superstitious approaches when treating OCD compared to non-minorities (Whites). Furthermore, they were less likely to take proper medication for OCD as well as getting proper treatment for it in a psychological setting than white people. This was illustrated by data such as one that stated how non-minorities were more likely to take medication for OCD than ethnic minorities (Katz, 1).

Why is it that certain demographics of people view and stigmatize OCD differently from others? This can be elucidated when analyzing the poor financial funding for mental health in continents like Asia, which often leads to a lack of professionals and resources, adding additional barriers in seeking help (Lauber and Rössler; Shinfuku). For instance, the number of psychiatric beds in Asian countries like China, The Republic of Korea, the Philippines and Indonesia remain relatively small (Shinfuku). Aside from that, the underrepresentation of ethnic minorities in second and tertiary care for OCD (which can be due to the more self-stigmatic nature of ethnic groups such as East Asians), can also lead to further barriers in seeking help or reducing stigma (Cruz et. al)

### **Modern-Day Stigma in OCD**

Despite significant advancements in OCD treatments and understanding, data shows it is relatively similar over the past years. In a recent survey from 2023 updating the status of stigmatic behaviors toward OCD, it was revealed that stigma towards mental health is still highly prevalent (Feuer). Around 30.3% - 40.4% of the 275 participants who self-reported to have a mental disorder recorded that they have experienced significant stigmatic behavior from healthcare providers. Results also conveyed how over 40% of participants avoided their healthcare providers due to their stigmatic behavior. Since people with OCD face a higher probability of getting sick than the general population, according to data, stigmatic behavior among healthcare providers could be life-threatening. This means that the stigmatic behavior of healthcare providers could potentially affect both the physical and mental health of OCD sufferers (Feuer). In another study, mental health care professionals were seen often

misunderstanding OCD. Data showed that mental health counselors and graduate students exhibited stigmatic behavior towards certain intrusive thoughts: violence, sexual and contamination thoughts. Additional data revealed that APA members often misidentified OCD symptoms. When given 5 vignettes that all exhibited OCD symptoms, results showed a 38.9% misidentification rate. These misidentifications can often increase stigmatic behavior since they promote symptoms that are not truly representative of OCD and can often trivialize the disorder. They also can prevent OCD sufferers from receiving proper intervention (Woods, 28). It is evident that the stigma behind OCD is still prevalent and important to further combat (Feuer).

With the advancement of technology, the complexity of OCD extends beyond in-person communication and is a frequent topic that arises regularly on social media. According to an analysis in 2018, it was revealed that mental illness portrayed in the media often promotes harmful stereotypes and misconceptions. Specifically, OCD sufferers are deemed highly intelligent, meticulous and tidy, which often provides comical relief for television viewers (Marie). For instance, a recent study conducted in 2019 revealed that OCD was the disorder among ten (five physical and five mental) that had the highest amount of trivialization on Twitter (Woods, 28). Further examination on Twitter revealed that the #OCD hashtag was used to convey non-disordered actions such as organizing pencils; these trivialized depictions were perceived negatively by non-OCD viewers (Woods, 28). They often expressed irritation and decreased sympathy for the disorder. In comparison, another study that exhibited these depictions to OCD sufferers revealed that they were frustrated by the casual usage of OCD when illustrating non-OCD behavior (Woods, 28). However, they still reported appreciation for OCD depictions in the media because they helped them initially identify their disorder.

Another study on TikTok also revealed interesting reports about OCD stigma. TikTok, a multi-billion dollar company that has amassed over 689 million monthly users, is known for opinionated content. Oftentimes, numerous users express their struggles and arguments on the platform, which are frequently met with extensive debate. Due to TikTok's user experience, calls for social change and action often become viral. When analyzing 50 of the most popular TikTok videos under the hashtag #OCD from women content-creators, results revealed a dichotomous pattern. Women content-creators were specifically recruited for this study since reports revealed that they often receive more negative feedback on social media, as well as having higher rates of OCD (Woods, 30). In one group, women were trivializing OCD and using the disorder as a replacement term for organization and cleanliness. However, in the second group, content creators accurately portrayed OCD and corrected common misconceptions. The group that minimized OCD made up around 56% of the videos. The content of these videos varied but they generally conflated unrelated symptoms with OCD symptoms. For instance, one video depicted a mother's annoyance at her daughter's messy painting as OCD. The group that accurately portrayed OCD primarily had content about clinically significant information regarding OCD. This can be exemplified through one of the mentioned content creators who debunked the common misconception that OCD is simply an organized desk, and describes a compulsion she has with spraying perfume in reaction to the thought that her mom would die (Woods, 33).

Although the example seems irrational to most viewers, it shows an accurate representation of how OCD can manifest, in comparison to the harmful assumptions made about the disorder in the context of solely cleanliness and organization. This sort of content is potentially helpful for OCD sufferers to view since it provides a space where they can cope and struggle together rather than in isolation. Despite some positive results from the TikTok study, it is indisputable that OCD is mainly misrepresented in the media (Woods, 35). Given the severity and distress associated with OCD, its light-hearted depiction in the media is detrimental to its sufferers (Woods, 28). Thus, it would be reasonable to speculate that the stigmatization of OCD would most likely grow in upcoming years, due to the mass expansion of media (Woods, 34).

### **The Future of Stigma in OCD**

Luckily, there have been numerous solutions suggested to reduce stigmatic behavior towards OCD. A recent technological approach has been developed to decrease stigmatizing attitudes towards OCD and improve mental health literacy. The app, called esTOCma, is a gamified application that teaches users about OCD. In the app, users need to defeat OCD stigma monsters in a series of 10 missions in order to save certain characters (Sorianno). With its psychoeducation and cognitive restructuring components, it can be effective not only for those who aren't educated about OCD, but also OCD sufferers who are seeking proper treatment and information about legitimate symptoms. Although a full analysis of its effectiveness has not yet been conducted, it is expected to be effective in the following categories: OCD individuals seeking help, providing information on OCD treatments, and reducing stigmatizing attitudes against people with OCD. This app has also been suggested to be used in educational settings so that children suffering from symptoms could get treatment as early as possible.

Due to the vulnerability of children who have OCD, interventions have been made to improve OCD literacy in school settings. 82.1% of teachers in a study correlated OCD with contamination symptoms, while only 36.8% knew about compulsions (Chaves). Additionally, only around 50% of educators could correctly identify classroom interferences from OCD. An intervention was developed that provided educators with educational sheets and questionnaires (Chaves). After this intervention, teachers reported highly increased knowledge of OCD symptoms, as well as improving their "willingness to help." Interventions like these are becoming more prevalent, as they are shown to be effective in reducing OCD stigma in educational settings (Chaves).

As both technological and educational advancements have decreased stigmatic behaviors toward OCD, it is important to note that solutions are still being developed. Due to the uniqueness of OCD stigma, more studies are needed to gain a clear understanding of how to reduce stigma in the future. Understanding how technology and education can be used to reduce stigma is especially important because these components are one of the two most prevalent attributes to modern day society. Thus, the development of OCD literacy and awareness among these platforms could serve useful in the future.

## Conclusion

Through this analysis, the following have been addressed: the background information regarding the history, stigma and symptoms of OCD, the evolution of OCD, the modern-day stigma of OCD, the stigma of OCD in various countries, and the future of stigma in OCD. With that in mind, many possible conclusions can be drawn. First, there have been numerous advancements in means of alleviating OCD stigma, but interventions in educational settings as well as the software development of OCD literacy apps such as esTOCma have proven successful and effective. This suggests that education and technology can be leveraged to improve solutions for stigmatic behavior toward OCD, and therefore more research is needed. Longitudinal data regarding the evolution of stigma would be helpful to determine whether advancements are being made or what factors may be stalling progress. It is clear that the stigma towards OCD has not been sufficiently eradicated to warrant the lack of current research. The stigmatic behavior of OCD is something that can potentially be life-threatening for sufferers, and act as obstacles for seeking medical treatment. Unfortunately, the research for this field is minimal and limited in methodology, even though it is such a consequential topic of study. Lack of longitudinal studies and data among ethnic minorities halts growth in the study of OCD stigma. In existing longitudinal studies, there is scarce information regarding how OCD stigma has changed over a certain span of time, which makes it difficult to identify clear trends of its evolution. For studies among ethnic minorities, there is limited distinction between ethnicities (e.g., “Easterners vs. Westerners” rather than country or regionally-specific populations), resulting in data that is too nonspecific to be truly representative. This limits the amount of progress that could be made in determining why OCD stigma is more prevalent in certain ethnicities than others. Additionally, certain presentations of information lead to bias. For instance, self-reports and surveys can induce biases from surveying conditions and social desirability, which can affect the responses from participants, altering some data to be unreliable (Latkin et. al).

Given the limitations in this body of literature, future research suggestions are presented. First, ecological momentary assessments could be employed to create an app that presents participants with surveys relating to OCD stigma throughout periods of time, to create longitudinal data that is more ecologically valid. This would make trends in OCD easier to identify, which would help elucidate further solutions. Second, the funding for OCD in countries with different ethnic groups could be improved. As previously mentioned, in East Asian countries such as Korea and China, there are relatively low numbers of psychiatric beds, which are statistical indicators for the lack of funding that goes into their psychiatric hospitals and mental healthcare. If more awareness is spread through media, the funding for OCD among minority groups could potentially improve. One way to do this is to intervene on social media. If social media apps bolster content creators with expertise, such as psychologists or counselors, compared to nonspecific creators such as “mental health advocates,” by creating exclusive hashtags, the spread of accurate OCD information can increase. Third, the implementation of social and emotional programs within schools can show benefits for reducing stigma. As

reported previously, the OCD stigma among educators decreased after participating in informative mental health programs. Currently, around 80% of schools provide some sort of mental health assistance; however, mental health still remains prevalent among their students, suggesting that some sort of reform should be made to their curriculum (Teich). One suggestion would be to provide varying and realistic depictions of OCD in these programs, as OCD is more commonly correlated with contamination compared to violent and sexual obsessions (Chaves). Fourth, providing mental health education for religious leaders could prove to be beneficial, since many minority groups often connect mental health to the supernatural or experience mental health care primarily through religious institutions and leaders. Lastly, support groups for OCD can prove to be beneficial, as they can create an outlet for OCD sufferers to “vent out emotions,” one of the five most common coping mechanisms for OCD (Thapa et al., 22). This could be effectively done on digital platforms which may increase accessibility for sufferers. Thus, the analysis of the evolution of OCD in different settings, suggests that although further research should be conducted, there are many solutions that could possibly reduce stigmatic behavior towards OCD.

## Works Cited

- A, Oberbeck., et al. “[On the History of Obsessive Compulsive Disorders: Their Place in the Nosological Classifications up to the Beginning of the 20th Century].” Europe PMC, 2013, [europepmc.org/article/med/24307089](https://europepmc.org/article/med/24307089).
- Akyurek, Gokcen, et al. “Stigma in Obsessive Compulsive Disorder.” *IntechOpen*, IntechOpen, 23 Jan. 2019, [www.intechopen.com/chapters/65312](https://www.intechopen.com/chapters/65312).
- Angermeyer, Matthias C., et al. “Changes in the Perception of Mental Illness Stigma in Germany over the Last Two Decades: European Psychiatry.” Cambridge Core, Cambridge University Press, 15 Apr. 2020, [www.cambridge.org/core/journals/european-psychiatry/article/abs/changes-in-the-perception-of-mental-illness-stigma-in-germany-over-the-last-two-decades/12745B211F93286933F8EE9027ECC27A](https://www.cambridge.org/core/journals/european-psychiatry/article/abs/changes-in-the-perception-of-mental-illness-stigma-in-germany-over-the-last-two-decades/12745B211F93286933F8EE9027ECC27A).
- Ansari, Eram, et al. “Cross-Sectional Study of Internalised Stigma and Medication Adherence in Patients with Obsessive Compulsive Disorder.” *General Psychiatry*, U.S. National Library of Medicine, 11 Mar. 2020, [www.ncbi.nlm.nih.gov/pmc/articles/PMC7066600/](https://www.ncbi.nlm.nih.gov/pmc/articles/PMC7066600/).
- Cefalu, Paul. “The Doubting Disease: Religious Scrupulosity and Obsessive-Compulsive Disorder in Historical Context - Journal of Medical Humanities.” SpringerLink, Springer US, 2 Feb. 2010, [link.springer.com/article/10.1007/s10912-010-9107-3](https://link.springer.com/article/10.1007/s10912-010-9107-3).
- Chaves, Antonio, et al. “Teachers’ Knowledge and Stigmatizing Attitudes Associated with Obsessive-Compulsive Disorder: Effectiveness of a Brief Educational Intervention.” *Frontiers*, Frontiers, 10 May 2021, [www.frontiersin.org/articles/10.3389/fpsy.2021.677567/full](https://www.frontiersin.org/articles/10.3389/fpsy.2021.677567/full).
- Chaves, Antonio. “Enhancing Mental Health Literacy in Obsessive-Compulsive Disorder and Reducing Stigma via Smartphone: A Randomized Controlled Trial Protocol.” *Internet Interventions*, Elsevier, 13 July 2022, [www.sciencedirect.com/science/article/pii/S2214782922000677](https://www.sciencedirect.com/science/article/pii/S2214782922000677).
- Ching, Terence. “Clinicalkey.” The Role of Ethnic Identity in OC Symptom Dimensions among Asian Americans, 2109, [www.clinicalkey.com/#!/content/playContent/1-s2.0-S2211364918301982?returnurl=null&referrer=null](https://www.clinicalkey.com/#!/content/playContent/1-s2.0-S2211364918301982?returnurl=null&referrer=null).
- Cole, Meredith, and Shannon L. Coleman. “Barriers to Treatment Seeking for Anxiety ... - Wiley Online Library.” *Barriers to Treatment Seeking for Anxiety Disorders: Initial Data on the Role of Mental Health Literacy*, 2009, [onlinelibrary.wiley.com/doi/abs/10.1002/da.20620](https://onlinelibrary.wiley.com/doi/abs/10.1002/da.20620).
- Corrigan, Patrick, and Andrea B. Bink. “Chapter 00170 - the Stigma of Mental Illness .” *The Stigma of Mental Illness*, 2016, [scitechconnect.elsevier.com/wp-content/uploads/2015/09/The-Stigma-of-Mental-Illness.pdf](https://scitechconnect.elsevier.com/wp-content/uploads/2015/09/The-Stigma-of-Mental-Illness.pdf).
- Cruz, Lorena Fernández de la, et al. “Ethnic Inequalities in the Use of Secondary and Tertiary Mental Health Services among Patients with Obsessive–Compulsive Disorder: The

- British Journal of Psychiatry.” Cambridge Core, Cambridge University Press, 2 Jan. 2018,  
[www.cambridge.org/core/journals/the-british-journal-of-psychiatry/article/ethnic-inequalities-in-the-use-of-secondary-and-tertiary-mental-health-services-among-patients-with-obsessive-compulsive-disorder/7B1B07877106BCF9B7F7A1AD40FA0FE1](http://www.cambridge.org/core/journals/the-british-journal-of-psychiatry/article/ethnic-inequalities-in-the-use-of-secondary-and-tertiary-mental-health-services-among-patients-with-obsessive-compulsive-disorder/7B1B07877106BCF9B7F7A1AD40FA0FE1).
- Cruz, Lorena Fernández de la, et al. “Illness Perception, Help-Seeking Attitudes, and Knowledge Related to Obsessive–Compulsive Disorder across Different Ethnic Groups: A Community Survey - Social Psychiatry and Psychiatric Epidemiology.” SpringerLink, Springer Berlin Heidelberg, 24 Oct. 2015,  
[link.springer.com/article/10.1007/s00127-015-1144-9](http://link.springer.com/article/10.1007/s00127-015-1144-9).
- David, Riggs, and Edna B. Foa. “Apa PsycNet.” American Psychological Association, American Psychological Association, 2019, [psycnet.apa.org/record/1993-98942-005](http://psycnet.apa.org/record/1993-98942-005).
- Davis, Lennard J. “Obsession: A History 9780226137797.” *Dokumen.Pub*, 2008,  
[dokumen.pub/obsession-a-history-9780226137797.html](http://dokumen.pub/obsession-a-history-9780226137797.html).
- Fennel, Dana, and Ana S. Q. Liberato. “Learning to Live with OCD: Labeling, the Self, and Stigma.” *Learning to Live with OCD: Labeling, the Self, and Stigma*, 2006,  
[www.tandfonline.com/doi/full/10.1080/01639620701233274](http://www.tandfonline.com/doi/full/10.1080/01639620701233274).
- Fennel, Dana, and Michael Boyd. “Obsessive-Compulsive Disorder in the Media - Taylor & Francis Online.” *Obsessive-Compulsive Disorder in the Media*, 2013,  
[www.tandfonline.com/doi/full/10.1080/01639625.2013.872526](http://www.tandfonline.com/doi/full/10.1080/01639625.2013.872526).
- Feuer, Shaindel. “Experienced and Anticipated Stigma among People with Mental Illness When Interacting with Healthcare Workers.” CUNY Academic Works, 2023,  
[academicworks.cuny.edu/jj\\_etds/284/](http://academicworks.cuny.edu/jj_etds/284/).
- G, Ponzini, and Shari A. Steinman. “Apa PsycNet.” A Systematic Review of Public Stigma Attributes and Obsessive–Compulsive Disorder Symptom Subtypes., American Psychological Association, 2022, [psycnet.apa.org/record/2021-45652-001](http://psycnet.apa.org/record/2021-45652-001).
- García-Soriano, Gemma. “ESTOCMA: Mental Health Application for Enhancing Mental Health Literacy About Obsessive-Compulsive Disorder (ESTOCMA).” CTG Labs - NCBI, 2022, [clinicaltrials.gov/study/NCT04777292](https://clinicaltrials.gov/study/NCT04777292).
- Glazier, Kimberly, et al. “Stigma and Shame as Barriers to Treatment for Obsessive-Compulsive And ...” *Stigma and Shame as Barriers to Treatment for Obsessive-Compulsive and Related Disorders*, 2015,  
[www.researchgate.net/profile/Monica-Williams/publication/280951508\\_Stigma\\_and\\_Shame\\_as\\_Barriers\\_to\\_Treatment\\_in\\_Obsessive-Compulsive\\_and\\_Related\\_Disorders/links/5c57bf74a6fdccd6b5e0ff53/Stigma-and-Shame-as-Barriers-to-Treatment-in-Obsessive-Compulsive-and-Related-Disorders.pdf?\\_sg%5B0%5D=started\\_experiment\\_milestone&origin=journalDetail](http://www.researchgate.net/profile/Monica-Williams/publication/280951508_Stigma_and_Shame_as_Barriers_to_Treatment_in_Obsessive-Compulsive_and_Related_Disorders/links/5c57bf74a6fdccd6b5e0ff53/Stigma-and-Shame-as-Barriers-to-Treatment-in-Obsessive-Compulsive-and-Related-Disorders.pdf?_sg%5B0%5D=started_experiment_milestone&origin=journalDetail).
- Guazzini, Andrea, et al. “Obsessive-Compulsive Disorder (OCD) Types and Social Media: Are Social Media Important and Impactful for OCD People?” MDPI, Multidisciplinary Digital Publishing Institute, 15 Aug. 2022, [www.mdpi.com/2254-9625/12/8/78](http://www.mdpi.com/2254-9625/12/8/78).

- Stengler-Wenzke, K., et al. “[Stigma Experiences of Patients with Obsessive Compulsive Disorders].” *Fortschritte Der Neurologie-Psychiatrie*, U.S. National Library of Medicine, 2004, [pubmed.ncbi.nlm.nih.gov/14745684/](https://pubmed.ncbi.nlm.nih.gov/14745684/).
- Katz, Jordan A., et al. *OCD in Ethnic Minorities*, [growththroughchange.com](https://growththroughchange.com/wp-content/uploads/2021/05/ocd-in-ethnic-minorities.pdf), 2020, [growththroughchange.com/wp-content/uploads/2021/05/ocd-in-ethnic-minorities.pdf](https://growththroughchange.com/wp-content/uploads/2021/05/ocd-in-ethnic-minorities.pdf).
- Latkin, Carl A., et al. “The Relationship between Social Desirability Bias and Self-Reports of Health, Substance Use, and Social Network Factors among Urban Substance Users in Baltimore, Maryland.” *Addictive Behaviors*, U.S. National Library of Medicine, Oct. 2017, [www.ncbi.nlm.nih.gov/pmc/articles/PMC5519338/](https://www.ncbi.nlm.nih.gov/pmc/articles/PMC5519338/).
- Lauber, Christoph, and Wulf Rössler. “Stigma towards People with Mental Illness in Developing Countries In ...” *Stigma towards People with Mental Illness in Developing Countries in Asia*, 2009, [www.tandfonline.com/doi/full/10.1080/09540260701278903](https://www.tandfonline.com/doi/full/10.1080/09540260701278903).
- Manderscheid, Ronald W., et al. “Evolving Definitions of Mental Illness and Wellness.” *Preventing Chronic Disease*, U.S. National Library of Medicine, Jan. 2010, [www.ncbi.nlm.nih.gov/pmc/articles/PMC2811514/](https://www.ncbi.nlm.nih.gov/pmc/articles/PMC2811514/).
- Marie, Camille Mirabelle. “Obsessive-Compulsive Disorder Stigma: Accurate and Inaccurate Portrayals in Electronic Media.” *UNI ScholarWorks*, 2018, [scholarworks.uni.edu/etd/402/](https://scholarworks.uni.edu/etd/402/).
- Marie, Camille. “Portrayals of Obsessive-Compulsive Disorder in the Media: Stigma and Perceived Humor.” *UNI ScholarWorks*, 2016, [scholarworks.uni.edu/agss/2016/all/11/](https://scholarworks.uni.edu/agss/2016/all/11/).
- Marques, Luana, et al. “Barriers to Treatment and Service Utilization in ... - Wiley Online Library.” *Barriers to Treatment and Service Utilization in an Internet Sample of Individuals with Obsessive–Compulsive Symptoms*, 2010, [onlinelibrary.wiley.com/doi/abs/10.1002/da.20694](https://onlinelibrary.wiley.com/doi/abs/10.1002/da.20694).
- McCarty, Ryan J., et al. “Stigma and Recognition of Different Types of Symptoms in OCD.” *Journal of Obsessive–Compulsive and Related Disorders*, Elsevier, 21 Dec. 2016, [www.sciencedirect.com/science/article/abs/pii/S2211364916301579](https://www.sciencedirect.com/science/article/abs/pii/S2211364916301579).
- Newth, S, et al. “Experience of Stigmatization by Relatives of Patients with Obsessive Compulsive Disorder.” *Archives of Psychiatric Nursing*, W.B. Saunders, 5 June 2004, [www.sciencedirect.com/science/article/abs/pii/S0883941704000524](https://www.sciencedirect.com/science/article/abs/pii/S0883941704000524).
- Ockiskova, Marie, et al. Full Article: Self-Stigma and Treatment Effectiveness in Patients With ..., 2021, [www.tandfonline.com/doi/full/10.2147/PRBM.S287419](https://www.tandfonline.com/doi/full/10.2147/PRBM.S287419).
- Pescosolido, Bernice, et al. “Evolving Public Views on the Likelihood of Violence ... - Health Affairs.” *Evolving Public Views On The Likelihood Of Violence From People With Mental Illness: Stigma And Its Consequences*, 2019, [www.healthaffairs.org/doi/10.1377/hlthaff.2019.00702](https://www.healthaffairs.org/doi/10.1377/hlthaff.2019.00702).
- Picco, Loren, et al. “Association between Recognition and Help-Seeking Preferences and Stigma towards People with Mental Illness: *Epidemiology and Psychiatric Sciences*.” Cambridge Core, Cambridge University Press, 8 Dec. 2016, [www.cambridge.org/core/journals/epidemiology-and-psychiatric-sciences/article/associat](https://www.cambridge.org/core/journals/epidemiology-and-psychiatric-sciences/article/associat)



- ion-between-recognition-and-helpseeking-preferences-and-stigma-towards-people-with-mental-illness/05B573BC7AB81666F4A6F7D627D31DB3.
- Picco, Louisa, et al. "Mediating Effects of Self-Stigma on the Relationship between Perceived Stigma and Psychosocial Outcomes among Psychiatric Outpatients: Findings from a Cross-Sectional Survey in Singapore." *BMJ Open*, British Medical Journal Publishing Group, 1 Aug. 2017, [bmjopen.bmj.com/content/7/8/e018228.abstract](http://bmjopen.bmj.com/content/7/8/e018228.abstract).
- Robinson, Patrick, et al. "Measuring Attitudes towards Mental Health Using Social Media: Investigating Stigma and Trivialisation - Social Psychiatry and Psychiatric Epidemiology." SpringerLink, Springer Berlin Heidelberg, 1 Aug. 2018, [link.springer.com/article/10.1007/s00127-018-1571-5](http://link.springer.com/article/10.1007/s00127-018-1571-5).
- Rössler, Wulf. "The Stigma of Mental Disorders - EMBO Press." *The Stigma of Mental Disorders: A Millennia-long History of Social Exclusion and Prejudices*, 2016, [www.embopress.org/doi/full/10.15252/embr.201643041](http://www.embopress.org/doi/full/10.15252/embr.201643041).
- Schomerus, Georg, and Matthias C. Angermeyer. "Changes of Stigma over Time." SpringerLink, Springer International Publishing, 1 Jan. 1970, [link.springer.com/chapter/10.1007/978-3-319-27839-1\\_9](http://link.springer.com/chapter/10.1007/978-3-319-27839-1_9).
- Schomerus, Georg, et al. "Evolution of Public Attitudes about Mental ... - Wiley Online Library." *Evolution of Public Attitudes about Mental Illness: A Systematic Review and Meta-Analysis*, 2012, [onlinelibrary.wiley.com/doi/abs/10.1111/j.1600-0447.2012.01826.x](http://onlinelibrary.wiley.com/doi/abs/10.1111/j.1600-0447.2012.01826.x).
- Shinfuku, Naotaka. "Mental Health Services in Asia: International Perspective and Challenge for the Coming Years." *Onlinelibrary.Wiley.Com*, 2002, [onlinelibrary.wiley.com/doi/full/10.1046/j.1440-1819.1998.00400.x](http://onlinelibrary.wiley.com/doi/full/10.1046/j.1440-1819.1998.00400.x).
- Simonds, Laura M., and Susan J. Thorpe. "Attitudes toward Obsessive-Compulsive Disorders - Social Psychiatry and Psychiatric Epidemiology." SpringerLink, Steinkopff Verlag, 2003, <https://link.springer.com/article/10.1007/s00127-003-0637-0>.
- Smestad, Laura. "How Is Obsessive-Compulsive Disorder Taught in Graduate Counseling Programs?" *aura.antioch.edu*, 2023, <https://aura.antioch.edu/cgi/viewcontent.cgi?article=1947&context=etds>.
- Stein, Dan J., et al. "Obsessive-Compulsive Disorder." *Nature News*, Nature Publishing Group, 1 Aug. 2019, [www.nature.com/articles/s41572-019-0102-3](http://www.nature.com/articles/s41572-019-0102-3).
- Steinberg, Daniel S., and Chad T. Wetterneck. "OCD Taboo Thoughts and Stigmatizing Attitudes in Clinicians - Community Mental Health Journal." SpringerLink, Springer US, 2 Nov. 2016, [link.springer.com/article/10.1007/s10597-016-0055-x](http://link.springer.com/article/10.1007/s10597-016-0055-x).
- Stengler-Wenzke, K. "[Stigma Experiences of Patients with Obsessive Compulsive Disorders]." *Fortschritte Der Neurologie-Psychiatrie*, U.S. National Library of Medicine, 2004, [pubmed.ncbi.nlm.nih.gov/14745684/](http://pubmed.ncbi.nlm.nih.gov/14745684/).
- Storch, Eric A., et al. "Handbook of Child and Adolescent Obsessive-Compulsive Disorder." Google Books, Google, 2007, [books.google.com/books?hl=en&lr=&id=Nq4ZYe1SnaEC&oi=fnd&pg=PA1&dq=19th%](http://books.google.com/books?hl=en&lr=&id=Nq4ZYe1SnaEC&oi=fnd&pg=PA1&dq=19th%)

- 2Bcentury%2BOCD%2B&ots=IzHOJ64udJ&sig=JIGhXk7erIGfzee3gHjxqFTQ4us#v=onepage&q=19th%20century%20OCD&f=false.
- Teich, Judith, et al. "What Kinds of Mental Health Services Do Public Schools in the United States Provide?" *ResearchGate*, 2007, [www.researchgate.net/publication/230875791\\_What\\_Kinds\\_of\\_Mental\\_Health\\_Services\\_do\\_Public\\_Schools\\_in\\_the\\_United\\_States\\_Provide](http://www.researchgate.net/publication/230875791_What_Kinds_of_Mental_Health_Services_do_Public_Schools_in_the_United_States_Provide).
- Thapa, Dev Kumar, et al. "The Application of Cope Inventory in Obsessive- Compulsive Disorder." THE APPLICATION OF COPE INVENTORY IN OBSESSIVECOMPULSIVE DISORDER, 2013, [www.researchgate.net/profile/Rabi-Shakya/publication/272871048\\_The\\_Application\\_of\\_Cope\\_Inventory\\_in\\_Obsessive-Compulsive\\_Disorder/links/598bd881aca272e57acb02c0/The-Application-of-Cope-Inventory-in-Obsessive-Compulsive-Disorder.pdf](http://www.researchgate.net/profile/Rabi-Shakya/publication/272871048_The_Application_of_Cope_Inventory_in_Obsessive-Compulsive_Disorder/links/598bd881aca272e57acb02c0/The-Application-of-Cope-Inventory-in-Obsessive-Compulsive-Disorder.pdf).
- Veale, David, and Alison Roberts. "Obsessive-Compulsive Disorder." *The BMJ, British Medical Journal Publishing Group*, 7 Apr. 2014, [www.bmj.com/content/348/bmj.g2183](http://www.bmj.com/content/348/bmj.g2183).
- Williams, Monnica, et al. "Obsessive-compulsive and Related Disorders in ... - Wiley Online Library." *Obsessive-Compulsive and Related Disorders in Ethnoracial Minorities*, 2017, [onlinelibrary.wiley.com/doi/abs/10.1002/9781118890233.ch48](http://onlinelibrary.wiley.com/doi/abs/10.1002/9781118890233.ch48).
- Woods, Erin, et al. "I'm so #OCD : A Content Analysis of How Women Portray OCD on Tiktok." "I'm So #OCD": A Content Analysis of How Women Portray OCD on TikTok, 2023, [tpcjournal.nbcc.org/wp-content/uploads/2023/06/Pages-27-38-Woods-OCD-on-TikTok.pdf](http://tpcjournal.nbcc.org/wp-content/uploads/2023/06/Pages-27-38-Woods-OCD-on-TikTok.pdf).
- Yang, Caroline, et al. "Cross-Cultural Differences in the Perception and Understanding Of ..." *Cross-Cultural Differences in the Perception and Understanding of Obsessive-Compulsive Disorder in East Asian and Western Cultures*, 2018, [www.tandfonline.com/doi/full/10.1080/17542863.2018.1468786](http://www.tandfonline.com/doi/full/10.1080/17542863.2018.1468786).

# Road Detection in Autonomous Vehicles through Deep Learning By Soeun Lee

## Abstract

In a rapidly advancing technological landscape, integrating deep learning in autonomous vehicles presents a pivotal challenge and opportunity. Our study briefly introduces some concepts in machine learning and its network structures. We aim to perform road segmentation using a U-Net image segmentation model trained on the Lyft Udacity dataset. We trained the model under different settings by adjusting parameters such as the initial channel, pooling method, activation function, and batch size. The performance of models is evaluated using the IoU metric. By comparing the performance of the models, we identify which settings yield higher performance for road segmentation task. Additionally, we observe the validation loss per epoch to determine which configuration provided the best training stability. This comprehensive evaluation allows us to identify optimal model setup for robust and reliable road segmentation models.

Keywords: Convolutional Neural Networks (CNN), U-Net, image segmentation, self-driving camera.

## 1. Introduction

Autonomous technology is currently a trending development in science, and much research is being done to combine this technology with deep learning. Road segmentation, essential for autonomous vehicles, distinguishes road areas from other elements like vehicles and pedestrians. Despite various approaches to developing image segmentation, it remains one of the most challenging tasks in computer vision. Challenges include image variability in size, resolution, and contrast, which affects segmentation quality and accuracy. This task remains challenging due to image variability in size, resolution, and contrast, which affects segmentation accuracy.

In order to improve road segmentation accuracy and while reduce computation load, we proposed an improved technique that adjusts the parameters of existing network models with different neural networks. As the era of self-driving cars emerges, our research focuses primarily on the application of deep learning in autonomous vehicles. Autonomous vehicles must accurately identify other vehicles using road images, which is why advanced road segmentation techniques are critical. We replaced the old network models with two alternative neural networks: Convolutional Neural Networks (CNNs) and U-Net. CNNs allow the direct processing of pixel data and handle image complexity without manual feature extraction, greatly improving image segmentation tasks' accuracy and efficiency. U-Net is a U-shaped architecture with contracting and expanding paths designed for precise localization. Experiments prove that our strategy improves road segmentation accuracy while minimizing computation load. As a result, our model is suitable for real-time processing in autonomous vehicle applications. Our model

shows potential for enhancing self-driving car technology by providing reliable and efficient road detection capabilities.

## **2. Image Segmentation**

### **2.1 CNN Architecture**

Deep learning employs multi-layered neural networks that process information similarly to human brains, recognizing patterns and evaluating scenarios. A neural network consists of an input layer, several hidden layers, and an output layer, with nodes interlinked, each possessing individual weights and thresholds. When a node's output exceeds its threshold, it activates and transmits information to the next layer. Networks with more than three layers, including inputs and outputs, qualify as deep learning algorithms [1].

Convolutional neural networks (CNN), a class of neural networks, have become dominant in various computer vision tasks, including radiology. CNNs automatically learn spatial hierarchies of features through backpropagation using convolution, pooling, and fully connected layers [2]. The convolution layer applies a convolution operation to the input, passing the result to the next layer, while pooling layers reduce dimensionality by aggregating input values. Fully connected layers perform classification based on extracted features, often using a softmax activation function.

### **2.2 Segmentation Model**

Image segmentation involves dividing an image into segments mapped to an object to produce a dense pixel-wise segmentation map. Each identified object is assigned a distinct color, facilitating individual analysis and interpretation.

Image segmentation is categorized into semantic, instance, and panoptic segmentation. Semantic segmentation classifies each pixel into categories such as road, vehicle, pedestrian, or traffic sign, aiding autonomous vehicles in understanding their environment. Instance segmentation differentiates between objects of the same category, which is crucial for navigating complex environments. Panoptic segmentation combines semantic and instance segmentation, providing a comprehensive view by simultaneously performing both classifications at the pixel level, which is essential for decision-making in autonomous driving.

Our study mainly focuses on semantic segmentation. Semantic segmentation assigns each pixel of an image to a specific category, which is crucial for distinguishing objects and defining their boundaries in various fields, such as self-driving, medical image analysis, and landscape classification [5]. AutoEncoders, networks consisting of an encoder and decoder, are applied to semantic segmentation tasks, with U-Net architecture enhancing their efficiency [6]. Atrous convolution expands the receptive field by introducing gaps within the convolution filter, allowing a larger context without reducing image resolution [7].

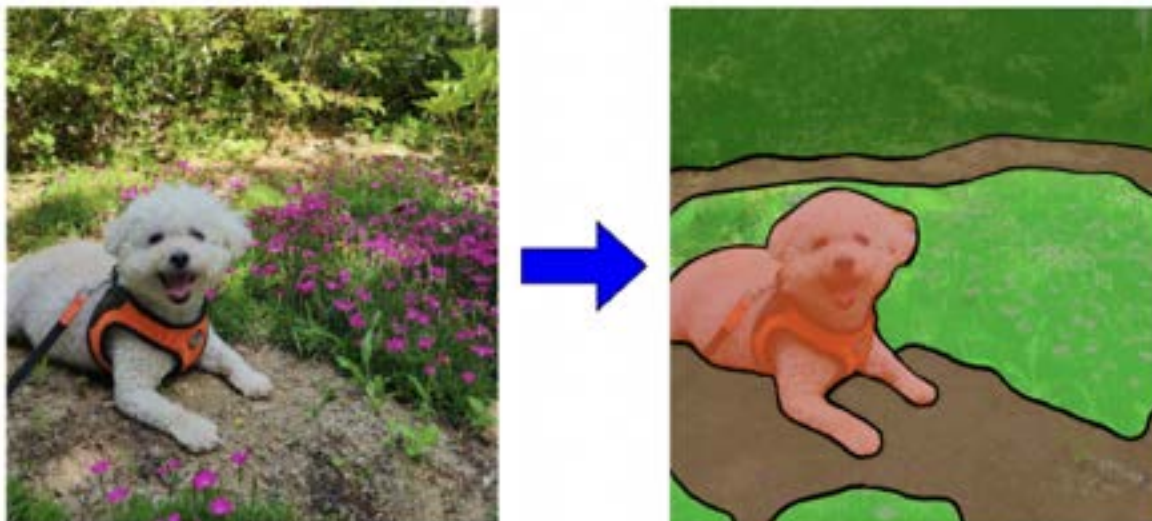

Figure 1. The input (left) and the result of the semantic segmentation task (right).

Fully Convolutional Networks (FCN) [4] is the first model that enables image segmentation using end-to-end, and SegNet [9] is an Encoder-decoder architecture that proposed the image segmentation model. It is a groundbreaking model that enables the segmentation task to be performed end-to-end. UNet [8] was first proposed for brain-related medical imaging, such as MRI (Magnetic Resonance Imaging), CT (Computed Tomography), and PET (Positron Emission Tomography) scans. It performs end-to-end segmentation tasks by downsampling with groups of convolutions and upsampling with transposed convolutions. Through Deeplab [10] atrous convolution, we could freely adjust the receptive field on an image, so we proposed a model that can capture the context with more variety and depth. Mask R-CNN [11] extended object detection models to include pixel-level masks. PSPNet [12] proposed a pyramid pooling module for global context information.

### 3. Road detection with segmentation model

#### 3.1 Road Detection via Semantic Segmentations

##### 3.1.1 Road dataset

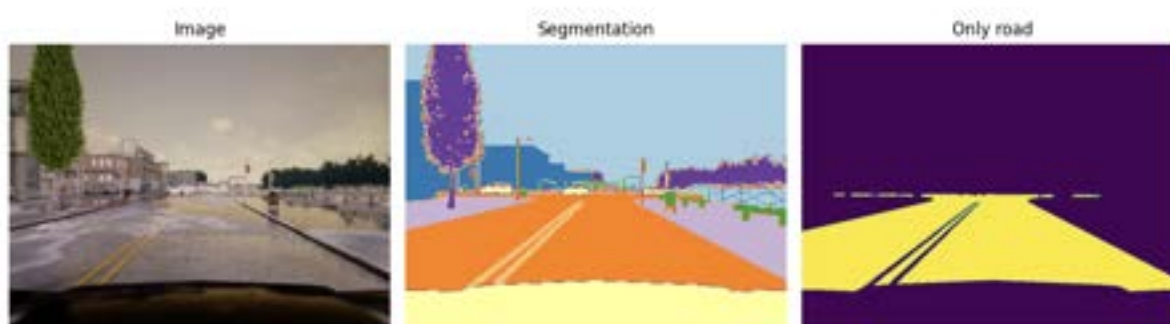

Figure 2. View from the car as seen by the camera (left), A segmentation map showing all 17 classes (middle) and ground truth showing only the road class (right).

The dataset used for this research is the Lyft Udacity road images dataset, featuring data images and labeled semantic segmentations from CARLA's self-driving car simulator. This dataset, part of the Lyft Udacity Challenge, is ideal for training machine learning algorithms to identify semantic segmentation of cars, roads, and other objects.

The dataset includes 5,000 images, each with categories for 12 objects, such as roads, lane-marking, traffic signs, sidewalks, fences, poles, walls, buildings, vegetation, vehicles, pedestrians, and others. From the image depicted Figure 2 (left), The semantic segmentation dataset is labeled with colors corresponding to each of the 12 objects. For our study, which aims to identify roads, only class number 7 corresponding to roads was used to construct the ground truth data cf. Figure 2 (right). Therefore, our road detection model learns and performs binary class semantic segmentation.

### 3.1.2 Model Selection and Architecture

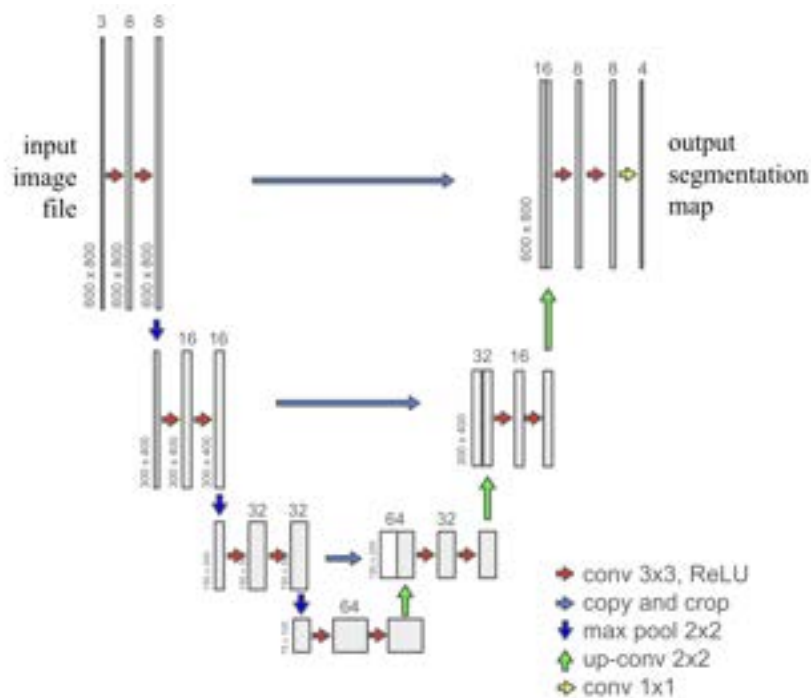

Figure 3. The architecture of the newly designed U-Net tailored for road detection.

Image classification is critical for pixel-level classification in object detection. Despite numerous algorithms for image segmentation using deep learning, we chose the U-Net model for this research. U-Net's architecture, consisting of contracting and expansion paths, enables effective learning even with small datasets [8].

The original U-Net model has a 1-channel input image. However, for road detection, the camera image viewed from the vehicle is RGB with 3 channels, so we modified the model accordingly to cover these 3 channel images. Additionally, Our road segmentation U-Net model has three layers to encoding and decoding.

Although Figure 3 only shows the initial channel set to 8 as the default model, we also trained models with the initial channel set to 16. The pooling method between layers was altered from max pooling to average pooling. Similarly, the model's activation function was changed from ReLU to Tanh.

## 3.2 Experiments

### 3.2.1 Implementation detail

Our road detection model was implemented with M1 pro macOS 14.3.1, and pytorch. Essential libraries included imageio, matplotlib, numpy, and pandas. Adam was used to optimize the model, and the learning rate was set to 0.001. The input camera image data were normalized to a range between 0 and 1. Within the U-Net architecture, batch normalization was applied after each convolution to enhance the model's stability.

For performance comparison experiments, we replaced the max pooling between the two convolutions and the transition to the next layer with average pooling. We alters the activation function after each convolution from ReLU to Tanh. The initial input channel to the U-Net was set to 8 for some experiments and changed to 16 to observe the performance and training progress. Finally, we varied the batch size of the input to the model, setting it to 32, 16, and 8, to observe the changes.

### 3.2.2 Performance Evaluation

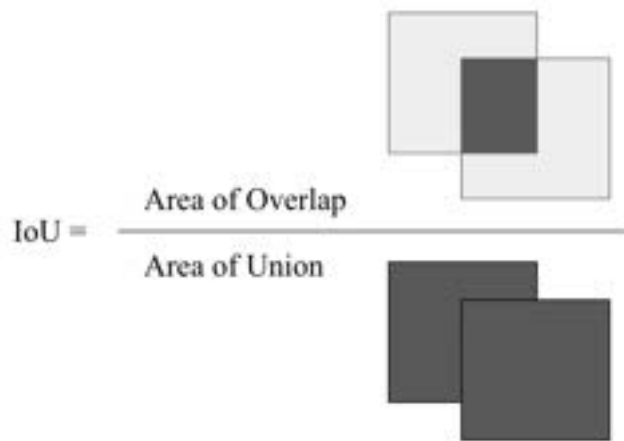

Figure 4. Diagram of the Intersection over Union (IoU) evaluation metric.

To determine whether our model made a good prediction, we used the Intersection over Union (IoU) formula, which compares numbers. The IoU formula is the width of the overlapped

area between the ground-truth bounding box and the predicted bounding box divided by the width occupied by the two bounding boxes.

### 3.2.3 Training Process

The training involved 100 epochs, processing 800 training samples and 100 validation samples. The model's performance, indicated by loss and validation loss metrics, improved over epochs. The model with the lowest validation loss is designated as the best model. The best model is then evaluated on the 100 test samples using the IoU metric which is described in Figure 4. Fine-tuning parameters such as pooling methods and activation functions optimized the model's efficiency and generalization capabilities.

### 3.2.4 Experimental Results

	initial channel	pooling	activation function	batch size	IoU	val_loss
1	8	max	ReLU	32	0.9512	0.0177
2		v			0.9590	0.0141
3	v			v 8	0.9848	0.0098
4	v	v	v	v 16	0.9525	0.0158
5			v	v 16	0.9413	0.0257
6	v	v		v 8	0.9887	0.0057
7		v	v	v 16	0.9474	0.0231
8		v		v 16	0.9677	0.0152
9	v		v	v 8	0.9756	0.0121
10	v	v		v 16	0.9794	0.0102
11	v			v 16	0.9877	0.0082
12		v	v	v 8	0.9615	0.0158

Table 1. IoU and validation loss of the final best model with the lowest validation loss for each parameter setting. A lower loss indicates better model performance, whereas a higher IoU signifies better model performance. Row 1 is the default model setting for comparison.



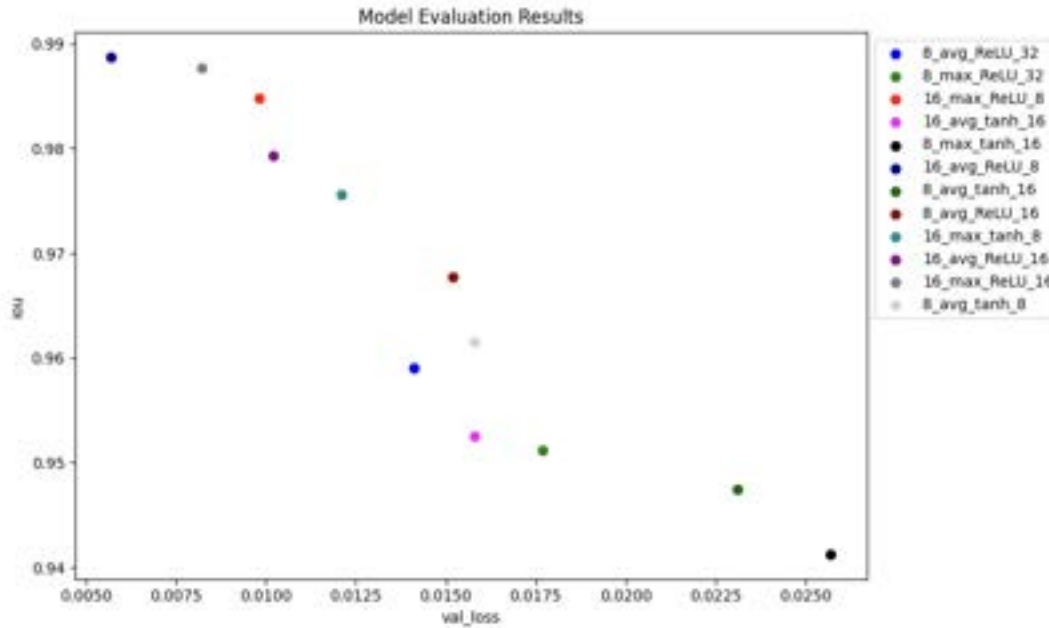

Figure 5. The best validation loss and IoU results based on different parameter settings. The strings in the legend represent, in order, the initial channel, type of pooling, name of the activation function, and batch size connected by underscores. The legend of items in Figure 5 corresponds to the rows in Table 1. An exception is the default item, which appears as the second item in the legend of Figure 5, contrary to the order in Table 1, where it is in the first row.

The setting in the first row of Table 1 is the default setting. In Table 1, column 1 indicates the initial channel, with 8 being the default, and models marked with a check are set to 16. In column 2, the pooling method is max pooling by default, but is changed to average pooling for the marked. The default setting for the activation function in column 3 is ReLU, but replaces it to Tanh. Column 4 represents the batch size, with 32 as the default setting, and the results of model evaluation with batch sizes of 16 and 8 are shown.

As shown in Figure 5 and Table 1, the best validation loss and IoU performance on the test samples are changed when the parameter settings are changed. In Figure 5, the green dot, the second item in the legend, is the result of the default model. Most models have high IoU and low validation loss compared to the default. The models that show lower or similar IoU performance compared to the default model are in rows 4, 5, and 7, where the common setting is the activation function Tanh. These results show that the model's performance is better when the activation function is ReLU than Tanh.

The model with the highest performance has an initial channel of 16, uses average pooling, has ReLU as the activation function, and a batch size of 8, as shown in row 6 of Table 1. In Figure 5, it corresponds to the dark blue dot. The next highest-performing models are in rows 11 and 3 of Table 1. These models share the common characteristics of augmenting the initial channel to 16 and decreasing the batch size from the default model. They achieve good performance while using the default max pooling and ReLU activation functions. In Figure 5, these models correspond to the gray dot and the red dot located at the top left. This trend

suggests that reducing the batch size while increasing the initial channel leads to better performance.

The model in Table 1, row 2 is the same as the default model, but the pooling method is changed from max pooling to average pooling. This model shows slightly higher performance compared to the default model. Additionally, the best-performing model in row 6 also uses average pooling instead of max pooling. These results suggest that changing the pooling method to average pooling leads to better performance.

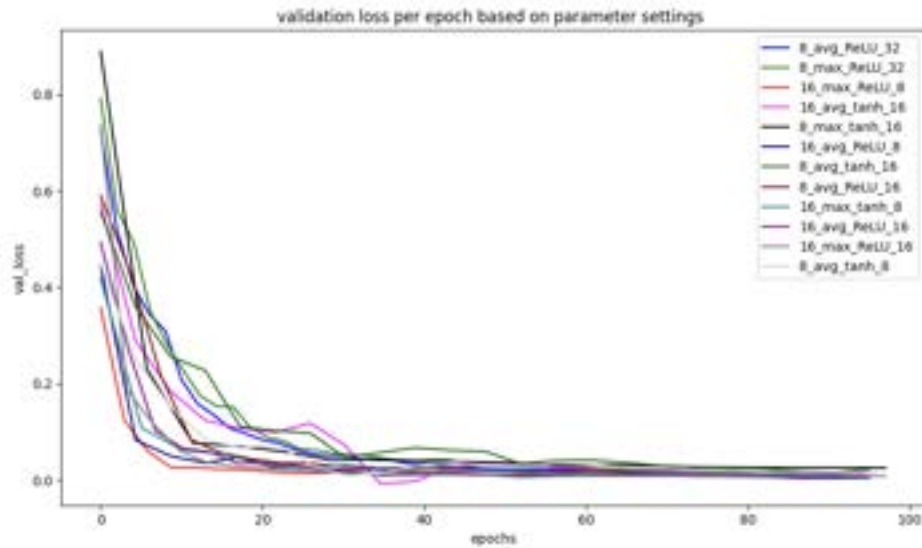

Figure 6. Validation loss per epoch according to parameter settings. The legend is the same as Figure 5.

By examining the changes in validation loss per epoch, we can assess the stability of the model's training process. A relatively stable model quickly achieves low validation loss and converges. In other words, the sooner a model achieves low validation loss, the higher its stability.

The dark blue line in Figure 6 corresponds to row 6 of Table 1. This dark blue line represents the learning progress of the highest-performing model, which appears to have low validation loss values in early epochs.

The default model, represented by the green line in Figure 6, shows the least stability in training, except for the dark green line. The dark green line corresponds to the model in row 7 of Table 1, which shows lower performance in both validation loss and IoU compared to the default model. These results indicate that changing the pooling method to average pooling can decrease training stability.

#### 4. Conclusion

In our study, for road detection, we trained a semantic segmentation model to detect roads. We trained model by adjusting the initial channel, pooling method, activation function, and batch size to observe the training progress and performance. Augmenting the initial channel from 8 to 16 resulted in improved performance. Changing the pooling method from max pooling

to average pooling also showed slightly better performance. The default activation function was ReLU, and switching it to Tanh resulted in poorer performance, indicating that ReLU is preferable in terms of both training stability and overall performance. Lastly, the fine-tuned batch sizes of 16 and 8 showed higher performance compared to the default batch size of 32. By improving the performance of the road segmentation model, incorporating this enhanced road segmentation into a self-driving system can increase the safety and reliability of self-driving vehicles.

## Works Cited

<https://www.ibm.com/topics/neural-networks>

<https://insightsimaging.springeropen.com/articles/10.1007/s13244-018-0639-9>

Chen, Liang-Chieh, et al. "Deeplab: Semantic image segmentation with deep convolutional nets, atrous convolution, and fully connected crfs." *IEEE transactions on pattern analysis and machine intelligence* 40.4 (2017): 834-848.

Long, Jonathan, Evan Shelhamer, and Trevor Darrell. "Fully convolutional networks for semantic segmentation." *Proceedings of the IEEE conference on computer vision and pattern recognition*. 2015.

Hao, Shijie, Yuan Zhou, and Yanrong Guo. "A brief survey on semantic segmentation with deep learning." *Neurocomputing* 406 (2020): 302-321.

Li, Pengzhi, Yan Pei, and Jianqiang Li. "A comprehensive survey on design and application of autoencoder in deep learning." *Applied Soft Computing* 138 (2023): 110176.

<https://www.analyticsvidhya.com/blog/2023/12/a-comprehensive-guide-on-atrous-convolution-in-cnns>

Ronneberger, Olaf, Philipp Fischer, and Thomas Brox. "U-net: Convolutional networks for biomedical image segmentation." *Medical image computing and computer-assisted intervention—MICCAI 2015: 18th international conference, Munich, Germany, October 5-9, 2015, proceedings, part III* 18. Springer International Publishing, 2015.

Badrinarayanan, Vijay, Ankur Handa, and Roberto Cipolla. "Segnet: A deep convolutional encoder-decoder architecture for robust semantic pixel-wise labelling." *arXiv preprint arXiv:1505.07293* (2015).

Chen, Liang-Chieh, et al. "Deeplab: Semantic image segmentation with deep convolutional nets, atrous convolution, and fully connected crfs." *IEEE transactions on pattern analysis and machine intelligence* 40.4 (2017): 834-848.

He, Kaiming, et al. "Mask r-cnn." *Proceedings of the IEEE international conference on computer vision*. 2017.

Zhao, Hengshuang, et al. "Pyramid scene parsing network." *Proceedings of the IEEE conference on computer vision and pattern recognition*. 2017.

# **Precision Medicine for Lung Cancer: Exploring the Efficacy and Advances of Antibody-Drug Conjugates By Advaith Dinesh**

## **Abstract**

Lung cancer kills millions of individuals in the United States each year, yet conventional treatments, such as chemotherapy, lack specificity and kill healthy and cancerous cells alike. In precision medicine, antibody-drug conjugates (ADCs) have arisen as a novel way to fight against cancer, specifically targeting malignant cancer cells. Previous studies have established the foundational principles of ADCs, demonstrating that they can improve target specificity and efficacy. By exploring a medicinal pathway that is different from conventional treatment, scientists may be able to broaden the availability of treatment options for patients fighting cancer. By reviewing a vast collection of articles, this paper gathers relevant and recent information regarding the efficacy, characteristics, and limitations to antibody-drug conjugates. Although variations do exist, most ADCs on the market and preclinical studies display promising results that support its advantageous characteristics; Yet, more research needs to be done to solidify these claims. Shedding light on ADCs may help bring in more funding and awareness dedicated to research of them, which may allow the drug's advancement to grow. Therefore, it would provide patients the opportunity to extend their lifetime.

## **Introduction**

Due to its lethal nature, cancer is a serious public health issue that is well-known worldwide. Second only to heart disease, it is one of the leading causes of death in the US. It is anticipated that there will be 611,720 cancer fatalities and 2,001,140 new cancer cases in the US in 2024 alone(Siegel et al.). Thus, it is with this knowledge that the best cancer treatments should be pursued. Emphasis must be placed on having an array of therapy options, which is critical for effectively combating cancer while allowing patients to live with minimum side effects, providing flexibility and hope. One of the distinguishing features of cancer is its vast range, both in terms of where it can be found and the heterogeneity within that area. Over 100 different types of cancer exist, such as those of the brain and prostate, each with its own set of characteristics and challenges. However, the main focus of this paper will be on novel techniques to treat lung cancer, as it is by far, the leading cause of death for cancer types. Targeted therapy drugs are intended to target specific receptors or chemical changes associated with cancer. They can be more successful in targeting and shrinking cancer masses while causing fewer side effects. Targeted therapy is an extremely promising option for treating lung cancer, or in this case, non-small-cell lung cancer (NSCLC). Non-small-cell lung cancer is the most common type of cancer, accounting for 81% of all lung cancer diagnoses(Siegel et al.), where abnormal cells form in lung tissue and multiply. Additionally, NSCLC typically grows and spreads less quickly, as compared to other forms of lung cancer such as small-cell-lung cancer (SCLC).

Stage III NSCLC encompasses a heterogenous group of individuals, with varying degrees of tumor size, location, and nodal involvement (the spread of cancer cells to lymph nodes). The

overall 5-year relative survival rate for persons with localized NSCLC (cancer that has not spread outside the lung) is 65%. However, around 70% of NSCLC patients are diagnosed after the cancer has spread beyond the lung. The 5-year relative survival rate for regional NSCLC, which indicates the cancer has progressed from the lung to adjacent lymph nodes, is approximately 37%. The 5-year relative survival rate for cancer that has spread to distant sections of the body, often known as metastatic lung cancer, is 9%. (“Lung Cancer - Non-Small Cell - Statistics”) Stage III NSCLC is characterized by a spread of cancer to nearby lymph nodes, but not to other organs. Determining the best therapy option for individuals with stage III NSCLC, particularly those with advanced nodal involvement (N2 and N3), can be difficult due to a lack of agreement on which is the most effective treatment method. Additionally, more research is needed to determine whether tri-modality therapy (surgery, chemotherapy, and radiation) is more effective than chemo-radiation alone in treating N2 illness (“Treatment of Stage III Non-Small Cell Lung Cancer”). Nevertheless, various initiatives have been taken to enhance patient survival rates. Chemotherapy is one of the most well-known cancer treatment approaches, and it refers to the injection of cytotoxic chemicals with the goal of eradicating the tumor or, in some cases, degrading it to alleviate symptoms and prolong life(Nygren). Cytotoxic refers to being toxic to cells, and these types of medications are typically administered in a precise combination of two or more drugs in order to maximize the likelihood of overcoming tumor resistance, ensure the regimen's efficacy against distinct tumor cell clones, and avoid significant harm to normal tissues(DeVita). Even while chemotherapy primarily targets proliferating cells, healthy cells are nevertheless at risk of being destroyed due to the non-specificity of cytotoxic medicines. An individual patient's treatment response can only be established after several cycles of chemotherapy have been completed. This is important because patients with a short anticipated survival have a significant risk of developing serious side effects, resulting in a lower quality of life before any potential benefits from the therapy can be assessed(Nygren). In addition, radiation therapy is another type of cancer treatment that involves administering high doses of radiation to a specific location in an attempt to completely eliminate or decrease a tumor. It has been estimated that over 50% of all cancer patients receive radiation therapy throughout the course of their disease(Keys et al.). Radiation therapy can cause tissue damage and systemic adverse effects, in addition to its tumor-sterilizing and tumoricidal effects. Despite efforts to reduce radiation therapy side effects through smaller targets and dedicated devices, they persist and vary in severity(*Acute Side Effects of Radiation Therapy*).

Cytotoxic agents based chemotherapy has been the main approach for the treatment of a wide range of cancers for decades(Loadman). Most chemotherapy drugs have a low therapeutic index, or in other words, the range between therapeutic dosage and a toxic one, is quite small. Furthermore, significant side effects are frequently attributed due to the lack of selectivity or targeting capability to an intended molecule/cell surface receptor. This could also cause damaging exposure to off-target organs, which may have serious repercussions for the health of a patient(C et al.). It is due to this issue that scientists are working on forming alternative treatments which address the issue of specificity. During the beginning of the 20th century,

scientist and Nobel Prize winner Paul Ehrlich developed the concept of a “magic bullet”, or a drug that would travel straight to its intended cell-structure target(K and A). Over 100 years of research have led to the formation of a novel cancer therapy, built upon the idea of the “magic bullet”. However, understanding this innovative medicine requires knowledge of antibodies. Antibodies are the immune system's weapon for combating infections, cancer, and other disorders. They fight by engaging with unwanted particles, proteins, and receptors, commonly referred to as antigens. Early Antibody-Drug-Conjugates (ADCs) consisted of monoclonal antibodies (lab-grown antibodies that mimic the function of natural antibodies) that were harvested from mice, known as murine monoclonal antibodies. Early conjugates had limited success in human clinical trials due to their provocation of an immune response, low levels of effectiveness, and inadequate selectivity for tumors over normal tissue(“Antibody Drug Conjugates”). However, as time has passed, various advancements in engineering the components of ADCs have garnered further attention for them. ADCs are one of the most promising vectors of cancer therapy, which is at the forefront of medical innovation. To reduce immunogenicity, humanized or completely human antibodies were used instead of murine antibodies. To increase the potency of therapy, medicines were utilized that were hundreds to thousands of times more toxic to cells than earlier treatments. Selectivity was also improved through careful target and antibody selection(“Antibody Drug Conjugates”). For example, one of the improvements that has been made includes humanizing the antibodies, as to minimize the immune response against them. Additionally, they have been made to have a longer half-life (time required for a substance to degrade to half its initial value) and high molecular weight, as to prevent degradation within the body. Attached to the mAb are linkers, either cleavable or non-cleavable. Linkers are chemical bridges that connect payload to the antibody. Linkers must be stable in circulation and have efficient release of payload at the target site. Cleavable linkers are designed to release the payload once the antibody has reached its intended target, while non-cleavable linkers remain intact after binding. Scientists design cleavable linkers to be broken down under specific cellular conditions, while non-cleavable linkers provide greater stability. The payload or warhead is a crucial component of ADC design that is triggered after release from ADC inside the cytoplasm of a tumor cell(McLaughlin and LoRusso), and it is desirable for the “warhead” or payload to be toxic enough to harm the tumor cells, even at low dosages(“Antibody-Targeted Drugs and Drug Resistance—Challenges and Solutions”). ADCs are administered intravenously (IV), to avoid degradation due to digestive enzymes. Once in circulation throughout the bloodstream, ADCs will locate their target antigen and bind.

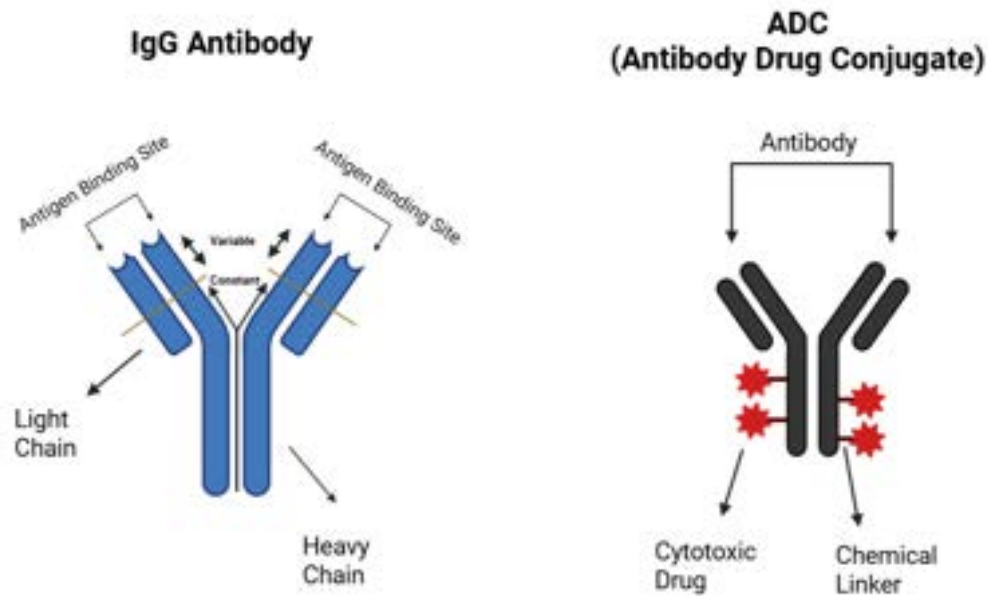

**Figure 1. Antibody versus Antibody-Drug Conjugate (ADC).** Immunoglobulin (IgG) antibody shown left. Consists of two heavy and two light chains. Variable regions near the top, constant regions on the bottom half. Variable regions are able to change shape depending on the target antigen. Antigen binding site is located on the top half as well. Antibody drug conjugate (ADC) on the right. Consists of an IgG antibody that supports chemical linkers on the side, acting as branches for the cytotoxic drugs to latch on to. Created with BioRender.com.

From there, the ADC becomes ingested or taken inside the cell via a process called endocytosis. Subsequently, the ADC is encased in a bubble-like structure made of membrane/phospholipids. This structure is called an early endosome. The early endosome fuses with lysosomes (Jonna and Subramaniam), an organelle of the cell which contains enzymes that can degrade substances. However, if the drug is attached to a cleavable linker, the ADC does not need to interact with lysosome to release the drug. However, ADCs with non-cleavable linkers require complete breakdown in the lysosome to discharge the drug. As the chemical linkers degrade, they release the drug. Once the drug is free from the ADC, it can then travel to the interior of the cell and start to induce damage upon the DNA or other structural components. As the target dies, some of this cytotoxic drug can leak out to neighboring cells, further multiplying the damage. This process is called the bystander effect.

ADCs have shown great promise in the treatment of non-small cell lung cancer owing to their precise method of action. Their ability to target a particular receptor minimizes unwanted toxicity, since ADCs don't tend to latch onto receptors that don't have the proper affinity to the antibody. Several ADCs to treat NSCLC are in clinical trials, each with a specific target. They are being used alone, or in combination with other therapies, to best optimize patient survival and well-being. It is vital that potential lung cancer ADC candidates have maximum specificity and efficacy, to reduce the chance of adverse patient side effects or reactions. In this paper, we



will explore the different drugs that have been developed for the treatment of NSCLC using ADCs, the mechanisms of antibody discovery, and limitations and ethical considerations.

### **Current Research on Antibody-Drug Conjugates**

In general, clinical trials are conducted in four stages. A limited group of people are tested for the first time in phase I trials (duration ranges from 1-4 months), and the main goal is to find out about safety and potential negative effects. After phase I, phase II trials involve 100–300 participants, which is a larger population (duration ranges from 3 months to 2 years). Subsequently, phase III studies (duration ranges from 1 to 4 years) examine a significantly larger sample size, usually ranging from 1,000 to 3,000 participants, to verify efficacy, track adverse events, compare the treatment to alternative approaches, and gather more data. Lastly, phase IV trials continue long after the medication is licensed and made available to the public. They cover a wide range of areas, including monitoring safety in the general population.

Currently, there are no NSCLC ADCs on the market. However, many are at promising stages of clinical development. One, for example, Trastuzumab deruxtecan (ENHERTU), has been conventionally used to treat breast cancer; it is also receiving more research in the treatment of NSCLC(Li Bob T. et al.). Trastuzumab deruxtecan, is an ADC that targets human epidermal growth factor receptor 2 (HER2), a key cell surface protein involved in healthy cellular growth and division. In cancer, however, HER2 is often mutated and expressed on the surface of malignant cells.

In a phase I trial evaluating HER2-targeted ADCs in NSCLC patients, researchers found that approximately 59% of enrolled patients reacted effectively to the treatment, with 88% demonstrating disease control, or the ability to suppress tumor growth(Sj). Additional phase II trials evaluating ADCs on HER2-expressing NSCLC tumors are currently enrolling.

Another example is Datopotamab deruxtecan (Dato-DXd), an ADC which targets TROP2 (Trophoblastic Cell Surface Antigen 2). Overexpression of TROP2 has been correlated with an increased mortality rate(Inamura et al.), thus the TROP2 surface glycoprotein (protein molecule with a carbohydrate attachment) is an attractive candidate for targeted therapy, due to its role in tumor progress.(Belluomini et al.) Phase I studies show that the overall response rate (ORR) was 24-26% across different dosages of Dato-DXd, with a median duration of response (mDOR) was 9.5 months(“MA03.02 TROPION-PanTumor01”). These values suggest ADCs are a promising therapeutic strategy for NSCLC..

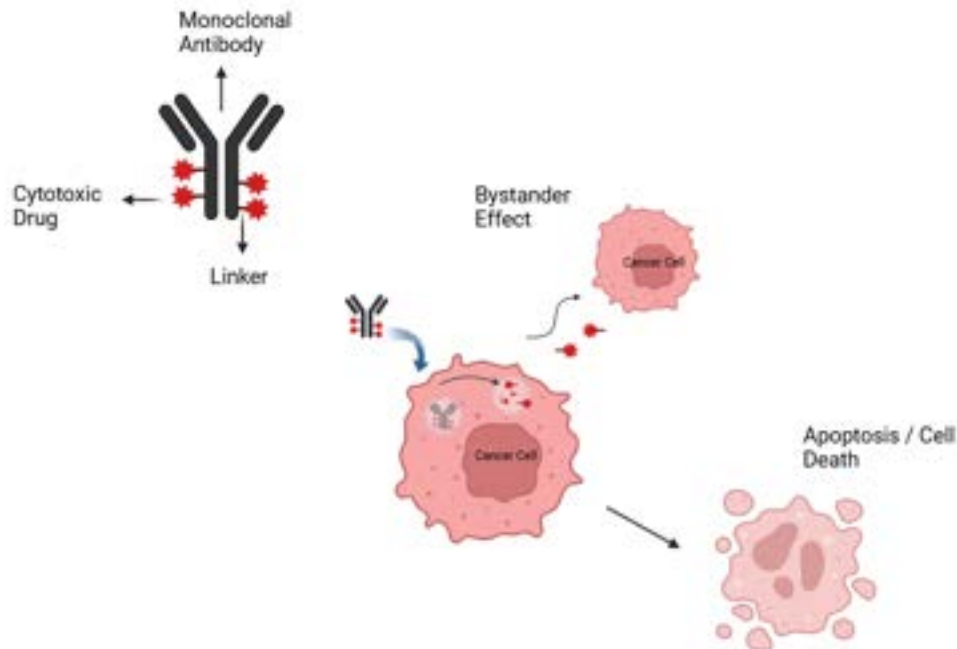

**Figure 2.** Mechanism of action for an ADC. ADC locates target antigen on the surface of a cancer cell. Then, it gets internalized into the cell. Once in the cell, chemical linkers are degraded, thereby releasing the cytotoxic drug into the cell. From there, the cell is able to inhibit cellular processes, eventually leading to cell death. Drugs can “leak” out of the initial cell and target neighboring cells, causing death. This is known as the bystander effect. Created with BioRender.com.

Trastuzumab deruxtecan (Enhertu) and (Datopotamab Deruxtecan) Dato-DXd are both cleavable linkers that share a similar pathway or mechanism of action in the body. Once Enhertu is bound to the HER2 receptor, or Dato-DXd is bound to TROP2, it is subsequently internalized, and the chemical linkers that hold the DXd drug are “chopped” off; this releases the drug into the cell environment. The DXd will then bind to an enzyme complex that helps regulate the structure of DNA, called topoisomerase I. This will eventually lead to the inhibition of DNA replication, cell cycle arrest (a stopping point in the cell where it no longer proceeds with duplication), and tumor apoptosis or programmed cell death. Trodelvy (sacituzumab govitecan-hziy) is another ADC that works in a similar method. Instead of releasing DXd, Trodelvy releases a drug called SN-38, which again interacts with topoisomerase I. By targeting the regions that promote excessive cell division (a typical characteristic of cancer), the ADCs can mitigate the spread and growth of cancers.

Overall, the development of ADCs shows great promise for the treatment of NSCLC. With studies reporting greater effectiveness at killing cancer, longer duration of response, and more, ADCs have the potential to lengthen and save the lives of the patients in a less destructive manner as other treatments.

## **Benefits of Antibody-Drug Conjugates for NSCLC**

There have been several hopeful patterns in the study of ADCs and NSCLC. One of the most crucial steps in selecting an appropriate ADC therapy is selecting the targeted disease the antigen. The practice of choosing overexpressed receptors, or receptors that are present in high quantities on target cells, and other surface proteins has generally been effective. Overexpressed antigens will be more prevalent than usual, meaning the antibodies targeting them will generally have higher binding success rates. Furthermore, effects like toxicity on healthy tissue or organs can be minimized by identifying these particular antigens. Toxicity on healthy tissue or organs can cause the body to shut down and fail in the most severe of cases. Selecting for overexpressed antigens such as HER3 and TROP2, ADCs may be more successful while posing fewer dangers to patients.

Lung cancer is known to be a highly heterogeneous tumor, with variety both within an individual tumor as well as among patients. This means that from one patient to the next, despite having the same type of cancer, tumors can look wildly different. One potentially significant advantage is the variety of mechanisms of action that scientists are selecting for NSCLC ADCs. Over time, single-target medicines can cause cancer cells to develop resistance to them, making them ineffective. This is because as a medicine constantly targets one pathway, the cell can develop resistance against it, thereby blocking effectiveness in future use. Conversely, it is more difficult for the cancer cell to become resistant to all the therapeutic approaches of an ADC, because of its broad mode of action.

The cytotoxic payload produced by ADCs for lung cancer has been shown to have tolerable safety profiles, with reported side effects falling within the known range. This implies that patients can manage NSCLC ADCs without experiencing the same crippling side effects that other treatment modalities might cause. Additionally, several ADCs for NSCLC are showing excellent clinical performance. For instance, individuals with previously treated metastatic (cancer that has spread to other regions of the body from the original site) NSCLC have demonstrated lasting responses to Trodelvy, while patients with advanced NSCLC have demonstrated similar findings to Enhertu (HER3-DXd) and AMG 757. Finally, integrating ADC treatment with other modalities would benefit from additional mechanisms of action, demonstrating the usefulness of multimodality treatment regimens.

## **Limits of Antibody-Drug Conjugates for NSCLC**

Even though there are many positive trends associated with NSCLC treatment via ADCs, many challenges simultaneously coexist. For example, limited antigen targets pose a huge problem for developing more ADCs. Identifying specific receptors, glycoproteins, or other markers that are highly expressive on tumors, but normal or minimally expressed on normal tissue, can be difficult. Furthermore, finding and validating target antigens is a challenging process that calls for extensive screening and rigorous validation. It includes the investigation of antigen expression in various cancerous and healthy tissues, together with the protective and functional immunological data associated with each antigen that can be retrieved for medicinal

intentions. The data that suggests that antigen expression can alter over time in response to therapy does not help with the difficulty of finding possible targets. Clinical management of patients becomes much more challenging due to the dynamic nature of antigen expression. Even though ADCs have comparatively fewer adverse effects than a treatment like chemotherapy, NSCLC ADCs still show off-target toxicity. When an ADC binds to antigens on healthy tissue, it may internalize the medication and cause off-target toxicity by inducing cell death in important organs or body components.

### **Ethical Considerations**

Ethical considerations are important in a variety of, if not all, industries, but especially when it comes to developing treatments for patients of diseases such as cancer. The safety of such therapies is a major part of ethics. Guidelines for testing ensure that therapeutics are rigorously experimented on and researched before they can be sold to consumers. This process is essential in maintaining patient health as it limits the amount of products that are inadequate or potentially dangerous for use. Conventionally, health and safety are the main ideas that come to mind when considering ethics. However, there are many ethical factors that must be explored and discussed.

One of those facets is cost and affordability. Patients often seek better treatment options for their cancer. Unfortunately, their search for the best treatment can be swiftly stunted, simply by the cost of certain therapeutics. Casgevy, for example, a therapeutic from Vertex Pharmaceuticals and CRISPR Therapeutics, is the first medicine to be approved in the US that uses the gene-editing tool CRISPR. Casgevy has the ability to help adults and adolescents suffering from sickle cell disease. Quite strikingly however, the price of Casgevy reaches anywhere from 2-3 million dollars (“FDA Approves First Gene-Editing Treatment for Human Illness”), a range which is completely out of reach for low to middle class patients. Affordability closely ties in accessibility to treatment. High costs create detrimental barriers to life-saving therapeutics, especially to those without proper insurance cover or overall wealth. Ensuring equity and equal access to cancer therapy can help alleviate the stress inducing and unhealthy financial burden that would usually be placed upon them.

Because of tumor heterogeneity, customized medicine is an additional aspect that must be considered. By customizing ADCs according to patient-specific parameters, patients can be guaranteed to get optimal treatments that maximize tumor-shrinking efficacy. Sadly, personalized medicine can often reach high costs, due to the greater effort required to test and determine specific needs. Importantly, however, all patients deserve the best outcome for their health despite financial status. This disparity in treatment access can be even more prevalent in developing countries that don't have the same support system as richer or more structured nations do. Ethical frameworks need to discuss the global access of not only cancer therapy, but all healthcare options around the world. Treatments that are not available in a multitude of regions can also pose a challenge for individuals seeking help. Without wider access to these treatment options, patients may be forced to travel outside their residence. If far enough, the cost

of travel could yet again be another burdening factor that dissuades or prevents people from getting the cancer therapy they require. Gender disparity for clinical trials is another issue that must be addressed. The research population in phase III clinical trials leading to the approval of new cancer medicines should, ideally, be more representative of the population that would eventually receive them. Women tend to have a 1.5-1.7-fold greater risk of developing an adverse reaction to a drug(Zopf et al.), which means that the dangers posed to them are significantly increased. Women, or anybody else who is at a higher risk of complications, should not be subjected to an increased risk of damage from a drug that is attempting to treat them. It has the potential to significantly degrade quality of life and produce further challenges to overcome. Although the number of women participating in clinical trials has increased over the last few decades, they remain underrepresented in preclinical research, early phase clinical trials, and even certain later phase cancer clinical trials. In the United States, this is especially true for women from minority groups and the elderly(Lee and Wen).

A large subset of ethical consideration also lies in the experimentation of animals. When in vitro options like phage display exist, many find it questionable to utilize the bodies of animals who cannot consent to research. As mentioned, antibody testing, which uses immunization, can cause suffering for an animal. It is important to discuss the necessity of animal testing for cancer therapy. Can scientific goals be achieved without the use of animals? If they can be achieved, what is the need for subjecting animals to unnecessary harm? Oftentimes, policies for the care of animals in research aren't properly shared to the public. The Institutional Animal Care and Use Committee (IACUC) is an oversight body that regulates and ensures that policies for the welfare of animals in testing are conserved and maintained. When presented with the full details of how animal testing occurs and the strict rules that come with it, the public can make much more educated decisions on the use of animal experimentation. Thus, researchers should communicate openly about the use of animal testing and their efforts to minimize harm, while also ensuring the best possible benefits for human health and survival.

### **Considerations for ADC Development: Antibody Discovery**

Many considerations exist when selecting an ideal target antigen. As previously discussed, antigen(s) exclusively or predominantly expressed on tumor cells but not on healthy tissue is an important aim. . There are two main classifications of target antigens. The first is tumor-specific antigens, which are only expressed on malignant tissue. When therapies target tumor-specific antigens, there is a diminished likelihood of unwanted toxicity and on non-cancerous parts of the body. Unfortunately, identifying target antigens in this category can be difficult, as there is a much smaller pool of potential proteins.. Another important consideration is the aforementioned the high heterogeneity of tumors between patients, adding an additional layer to identifying tumor-specific target antigens. The second type are tumor-associated antigens, which are antigens that are highly expressed on tumor cells but may also be lowly expressed in healthy tissue. Tumor-associated antigens also invite the possibility of on-target off-cell toxicity, since ADCs may still attach onto healthy tissue, resulting in apoptosis.

Off-target impacts are a concern because damaging healthy tissue can create many health concerns and even cause failure in the organs and other parts of the body in extreme cases.

However, identifying antigens is just one step in creating potential ADC treatments. Target antigens are combined with an antibody that can specifically attach to that particular antigen, making the antibody-discovery component a crucial subject. One well-known method of antibody discovery involves phage display. Bacteriophages are viruses that infect bacteria and archaea. Interestingly, bacteriophages represent the majority of all organisms on Earth, with their estimated population size being about  $10^{31}$ . Unlike the more commonly known type of phage, with an icosahedral capsid (3-dimensional figure made up of equilateral triangles, where the DNA is encased), filamentous phages are composed of major coat proteins which surround the genetic material, forming a thin noodle-like form. These characteristics allow scientists to easily manipulate certain aspects of the phage. By manipulating a sequence of genetic instructions that code for a coat protein, scientists can express a protein on the outer layer of the filamentous bacteriophage. This ability will later show importance in a key process called phage display. Phage display is one way that scientists can find the antibodies to target their specific target receptor, thereby providing a way for a drug to accurately locate and affect a cell.

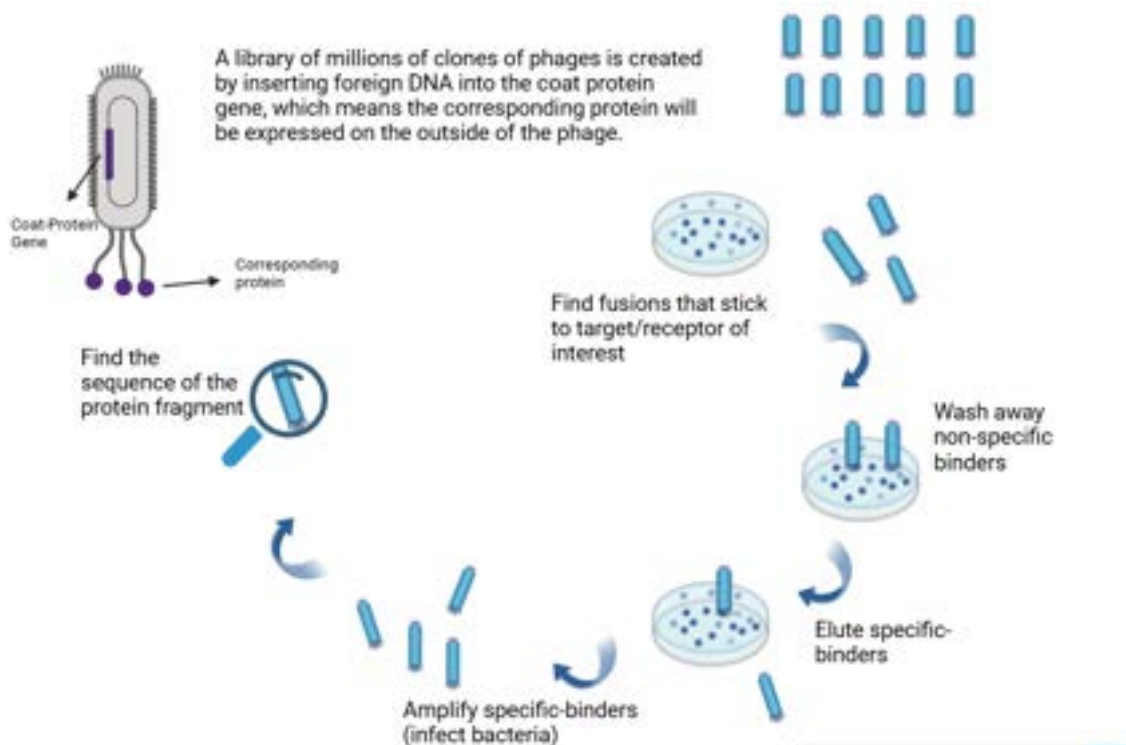
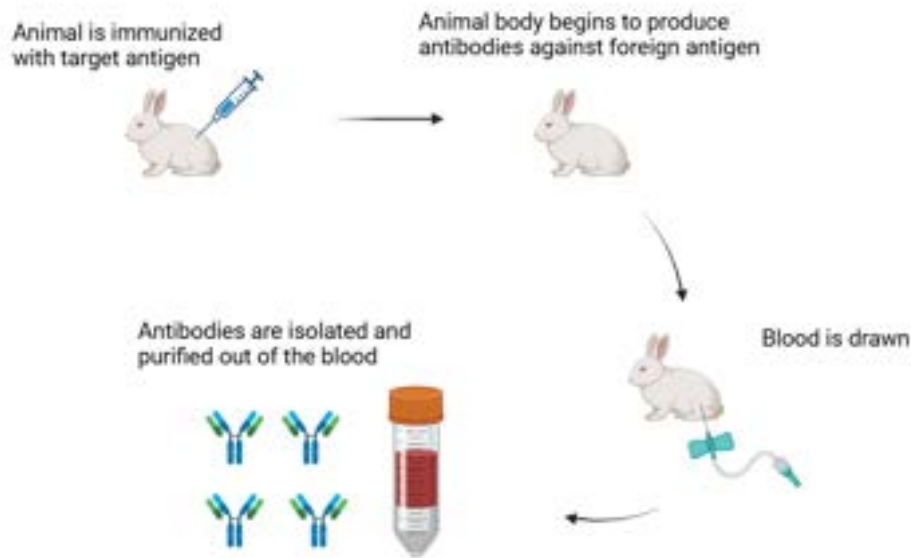

**Figure 3.** Phage display workflow. By exposing a receptor of interest to a phage library, one phage may be able to stick on, due to affinity towards the receptor. Then, washing away all the other phages isolates only the phages that have some affinity. From there, repeating or toughening wash conditions for more cycles means that the phages which do stick, show strong affinity for the receptor. After selecting a phage, scientists can then amplify the phage by letting

it infect bacteria, and afterwards, they can find the sequence of the protein fragment that was inputted into the phage. Created with BioRender.com.

Phage display refers to the expression of certain proteins on the surface of filamentous phage through fusion with phage coat protein, with the genetic sequence contained therein, connecting observable characteristics to genotype selection (Ce et al.). In-vitro methodology is the term for this process, which takes place outside a living organism.

IgG (Immunoglobulin G) are the most common type of antibody, and are widely used in therapeutics. They all have unique variable regions and constant regions, of which the latter is utilized. There are variable heavy and variable light chains. The exact region where bindings occur on the antibody is called the paratope, also known as the antigen binding site. The variable regions of the antibody are where these binding sites are. When sequences of antibody variable regions are inserted into the coat protein gene, the bacteriophage's exterior will express the antigen binding site, which is relevant to the realm of antibody finding. Over time, as genes get mixed and matched, vast "libraries" of phage/antibody combinations are created, usually with a size between  $10^6$  and  $10^{11}$ . When paired with antibody libraries, phage display enables quick in vitro selection of antigen-specific antibodies and retrieval of their matching coding sequence (Ce et al.). In other words, by exposing a target antigen to a library of antibody variable-region encoding bacteriophages, scientists are able to figure out which antibody is most fit for attaching onto that antigen. A typical, yet heavily generalized, workflow of phage display includes 5 main steps. The first is binding, which means finding fusions which are latched onto an immobilized antigen of interest. From there, it is important to wash off the non-specific binders (antibody fragments which have bound but have no specific affinity or attraction for the antigen), to ensure that the fusions that do remain, are specific. Eluting or eluting the remaining fusions unsticks them from their binders, and they can then be amplified by allowing them to infect bacteria, which produces many identical copies. Finally, scientists can sequence the protein coat gene and figure out the best antibody fit for their target antigen. This process can be repeated multiple times until the strongest candidate is found.



**Figure 4.** Animals get immunized with an antigen of choice. The animal's body begins to produce antibodies that can locate the foreign presence of the antigen. The blood is drawn, and the newly created antibodies can be purified out of the blood and used for other purposes.

Created with BioRender.com.

Another method of antibody generation is called animal immunization. In this methodology, an animal is immunized with a certain antigen, with the goal of triggering the immune system. As a result, the immune system of the animal induces an immune response, and the body starts to produce antibodies that are catered towards the specific antigen that it was exposed to. Eventually, these antibodies can be isolated and purified out from the animal's blood, and be used for other purposes. One of the main advantages to animal immunization is *in vivo* affinity maturation (Laustsen et al.). During the immunization process, the body naturally selects for antibodies with the highest affinity, or tendency to combine. Instead of going through a washing and elution process like a phage display, this work can be done by the body of the animal. Animals have a high variety of immune cells that make up different antibodies. These antibodies are produced via somatic recombination, during which gene segments are shuffled and mixed to create different versions of antibodies. Because of this variety, animals can develop antibodies which can target a wide range of antigen shapes and structures.

Even though animal immunization is able to specify antibodies through natural processes, there is still a lack of control in this specificity. Lack of control over specificity can lead to unwanted variability in antibody performance and efficacy. Furthermore, animal immunization has drawn much concern over ethical considerations, with those against it determining that the immunization process subjects animals to pain and that they are sacrificed during preclinical studies. (Laustsen et al.) Animal consumption is yet another concern, as large scale production of antibodies may require substantial amounts of animals. Due to their foreign nature, animal antibodies may also be rejected in humans, and elicit a harmful immune response. As a result,



the shout for alternatives has greatly increased. Phage display is one of these alternatives, yet it too, also has limitations which should be considered. One, for example, is the constraint in phage libraries. Phage libraries are limited by the capability of the phage genome to harbor foreign DNA sequences, since larger foreign sequences may cause instability(Jaroszewicz et al.). Thus, they may not be able to display the true variety of antibodies that exist, which may hinder discovery. Selection conditions are especially significant for phage display, and they include factors such as antigen concentration, material composition, and selection stringency. If these conditions are suboptimal, the efficiency of selected antibodies could be lowered, and therefore more testing would be required. Not to mention, phage display needs specialized equipment, access to libraries, and much more demanding requirements. However, despite their differences, both phage display and animal immunization are tools of antibody discovery that allow for the procurement of specialized antibodies that can then be utilized for therapeutic drug delivery.

### **Conclusions and Future Directions**

Finding alternative cancer therapeutics is a necessary practice. Many factors contribute to the shortcomings of current treatment options, and these shortcomings must be addressed by future options. Cancer has the ability to become resistant to multiple drugs. There are a plethora of underlying multidrug resistance mechanisms that aren't fully understood, and this makes the development of effective solutions very challenging.(M et al.) Unfortunately, the recycling of the same treatments will eventually lead to a lack of effectiveness, which means the necessity for treatments that target different pathways or mechanisms will continue to rise.

The effects on patients is another aspect of therapy that must be considered. Known as one of the most popular forms of treatment, chemotherapy is acknowledged for its effectiveness in fighting lymphoma. However, in the fight against other cancers, chemotherapy often does not cure, but rather increases longevity of life. Often chemotherapy is given as a palliative measure, not a cure. Chemotherapy is also observed to have daunting side effects, such as immediate signs of toxicity. WHO classifications of chemotherapy side-effects start from mild (grade 1), moderate (grade 2), severe (grade 3), or life threatening or disabling (grade 4). The skin, hair, blood, bone marrow, kidneys, and gastrointestinal tracts are all parts of the body in which immediate effects can be seen. All organs can also be damaged. In its 2020 report on cancer statistics, the International Agency for Research on Cancer provided data on cancer incidence and mortality. With an anticipated 1.8 million fatalities (18%), lung cancer continued to be the most common cause of cancer-related mortality. Colorectal (9.4%), liver (8.3%), stomach (7.7%), and female breast (6.9%) cancers were the next most common causes.(Sung et al.) As shown by the figures, the results are relatively disappointing, and tell us that the current standard of care cannot control cancer. In summary, the conventional or more widespread therapy techniques fail to meet the challenges of tumor adaptation, specificity, and efficacy, yet often serve as the baseline form of treatment for patients.

Where other therapeutics lack, ADCs may offer advantageous benefits. One of these advantages, for example, is the targeting ability of ADCs. Harmful toxicity results from death or damage to healthy cells in the body. Treatments which aren't specific enough to only target cancer cells may adversely affect the necessary components of the body. Due to the specific nature of ADCs, due to the characteristic of antibodies being able to target a specific receptor, ADCs are designed to target only cancer cells. On-target toxicity allows for the destruction of cancer cells, while keeping the surrounding healthy tissue or organs in healthy condition. By having target specificity, ADCs may also be able to bypass resistance mechanisms that are associated with exposure to other therapies. Personalized medicine is another effective option that is offered by ADC treatment. By finding antibodies with specific affinity for patient tumors, the overall effectiveness in targeting can be increased. By following a process of target identification, linker/payload selection, conjugation (combining the linker with the drug), and further testing, ADCs can be created and distributed for patient-specific use.

As mentioned, the high cost of treatments remains as one of the largest barriers to equal access to life-saving medical care. Many factors contribute to the high cost of medicine. One is due to research and development of therapeutics, which takes up a large amount of time and resources, all of which contribute to costs. Additionally, not all treatments are guaranteed success. As certain treatments fail in production, their costs are added on to later successful therapeutics to remedy profits. The ability for companies to patent new drugs allows them to set higher prices on these drugs, since there exists no form of competition that would force fairer prices. When it comes to healthcare inequality, individuals who are uninsured are often the ones who face the largest barriers in access to medicine, since they don't have the resources to pay like others may do. When it comes to ADCs, personalized medicine may be the best approach in reducing cancer size and influence. However, personalized medicine is extremely expensive, as testing for individual patients requires a multitude of screenings and labs which take up time and money.

Ensuring that produced ADCs are representative for a diverse set of individuals also remains a challenge. Depending on race, gender, and other factors, the effectiveness of ADCs may largely vary. Genetic variation based on race may alter the effects and responses to certain drugs. Thus, understanding these changes and alterations will be key for determining the best options for all individuals affected with NSCLC. Socioeconomic status is another key factor that must be addressed in the production of ADCs. As a novel technique, ADC therapy must be accessible to a variety of subgroups/subpopulations. A lack of awareness may also contribute to unequal access. Companies which produce ADC drugs must find ways to educate all populations on the possibilities that their therapeutic may provide.

Finally, resistance mechanisms are a limitation that all cancer treatments, including ADCs, face. Eventually, cancers may form resistance to the cytotoxic drugs linked onto antibodies. Finding ways to overcome or disrupt resistance mechanisms will be the key determinant of ADC treatment longevity. It's been suggested that combination therapy may be the best form of achieving this task. By having two different therapies target different

mechanisms at differing periods of time, a cancer cell may continue to be susceptible to its effects. During a cycle of one specific treatment, cells may initially show signs of deterioration, but eventually, resistance strains may start to appear. During this resistance period, the cycle of treatment can be switched with a therapeutic that targets a different mechanism or receptor. As the cell builds immunity to the new threat, it loses its immunity to the previous threat. Through this method, therapeutics may be able to be used in longevity, thus increasing the effectiveness and chance of the cancer being eradicated.

In conclusion, ADCs are a promising candidate for cancer therapy and have enormous potential for treatments against NSCLC and other cancers. As the search for better ADCs continues, a variety of questions must be asked, to procure the most effective and non-harmful ADC that can be distributed to all patients in an equitable manner. One of the industry's most vital concerns revolves around understanding and overcoming mechanisms of resistance, not only to ADCs, but to all therapeutic drugs. A suggested method of overcoming resistance is combination therapy. Is the combination of multiple therapeutics in a treatment plan the most effective way of fighting cancer, and if so, which combination will produce the best results? Various clinical trials are now testing the efficacy of combination therapies including ADCs being paired alongside conventional chemotherapy regimens.

## Works Cited

- Acute Side Effects of Radiation Therapy*. [link.springer.com](https://link.springer.com),  
<https://link.springer.com/book/10.1007/978-3-319-55950-6>. Accessed 18 Feb. 2024.
- “Antibody Drug Conjugates : Current Opinion in Oncology.” *LWW*,  
<https://doi.org/10.1097/CCO.000000000000108>. Accessed 25 Feb. 2024.
- “Antibody-Targeted Drugs and Drug Resistance—Challenges and Solutions.” *Drug Resistance Updates*, vol. 18, Jan. 2015, pp. 36–46. [www.sciencedirect.com](http://www.sciencedirect.com),  
<https://doi.org/10.1016/j.drug.2014.11.001>.
- Belluomini, Lorenzo, et al. “Antibody-Drug Conjugates (ADCs) Targeting TROP-2 in Lung Cancer.” *Expert Opinion on Biological Therapy*, Nov. 2023. [world, www.tandfonline.com](http://www.tandfonline.com),  
<https://www.tandfonline.com/doi/abs/10.1080/14712598.2023.2198087>.
- C, Lindley, et al. “Perception of Chemotherapy Side Effects Cancer versus Noncancer Patients.” *Cancer Practice*, vol. 7, no. 2, Apr. 1999. [pubmed.ncbi.nlm.nih.gov](http://pubmed.ncbi.nlm.nih.gov),  
<https://doi.org/10.1046/j.1523-5394.1999.07205.x>.
- Ce, Chan, et al. “The Role of Phage Display in Therapeutic Antibody Discovery.” *International Immunology*, vol. 26, no. 12, Dec. 2014. [pubmed.ncbi.nlm.nih.gov](http://pubmed.ncbi.nlm.nih.gov),  
<https://doi.org/10.1093/intimm/dxu082>.
- DeVita, Vincent T. *Devita, Hellman, and Rosenberg’s Cancer: Principles and Practice of Oncology, 11e*. Lippincott Williams & Wilkins, a Wolters Kluwer business, 2019.  
[oncology.lwwhealthlibrary.com](http://oncology.lwwhealthlibrary.com),  
<https://oncology.lwwhealthlibrary.com/book.aspx?bookid=2549>.
- “FDA Approves First Gene-Editing Treatment for Human Illness.” *NPR*, 8 Dec. 2023,  
<https://www.npr.org/sections/health-shots/2023/12/08/1217123089/fda-approves-first-gene-editing-treatments-for-human-illness>.
- Inamura, Kentaro, et al. “Association of Tumor TROP2 Expression with Prognosis Varies among Lung Cancer Subtypes.” *Oncotarget*, vol. 8, no. 17, Apr. 2017, p. 28725.  
[www.ncbi.nlm.nih.gov](http://www.ncbi.nlm.nih.gov), <https://doi.org/10.18632/oncotarget.15647>.
- Jaroszewicz, Weronika, et al. “Phage Display and Other Peptide Display Technologies.” *FEMS Microbiology Reviews*, vol. 46, no. 2, Mar. 2022, p. fuab052. *Silverchair*,  
<https://doi.org/10.1093/femsre/fuab052>.
- Jonna, Sushma, and Deepa S. Subramaniam. “Molecular Diagnostics and Targeted Therapies in Non-Small Cell Lung Cancer (NSCLC): An Update.” *Discovery Medicine*, vol. 27, no. 148, Mar. 2019, pp. 167–70.
- K, Strebhardt, and Ullrich A. “Paul Ehrlich’s Magic Bullet Concept: 100 Years of Progress.” *Nature Reviews. Cancer*, vol. 8, no. 6, June 2008. [pubmed.ncbi.nlm.nih.gov](http://pubmed.ncbi.nlm.nih.gov),  
<https://doi.org/10.1038/nrc2394>.
- Keys, Henry M., et al. “Cisplatin, Radiation, and Adjuvant Hysterectomy Compared with Radiation and Adjuvant Hysterectomy for Bulky Stage IB Cervical Carcinoma.”  
<https://doi.org/10.1056/NEJM199904153401503>, Massachusetts Medical Society, 15

- Apr. 1999, <https://doi.org/10.1056/NEJM199904153401503>. world.
- Laustsen, Andreas H., et al. “Animal Immunization, in Vitro Display Technologies, and Machine Learning for Antibody Discovery.” *Trends in Biotechnology*, vol. 39, no. 12, Dec. 2021, pp. 1263–73. *DOI.org (Crossref)*, <https://doi.org/10.1016/j.tibtech.2021.03.003>.
- Lee, Eudocia, and Patrick Wen. “Gender and Sex Disparity in Cancer Trials.” *ESMO Open*, vol. 5, no. Suppl 4, Aug. 2020, p. e000773. *PubMed Central*, <https://doi.org/10.1136/esmoopen-2020-000773>.
- Li Bob T., et al. “Trastuzumab Deruxtecan in HER2-Mutant Non-Small-Cell Lung Cancer.” *New England Journal of Medicine*, vol. 386, no. 3, Jan. 2022, pp. 241–51. *Taylor and Francis+NEJM*, <https://doi.org/10.1056/NEJMoa2112431>.
- Loadman, P. “Anticancer Drug Development.” *British Journal of Cancer*, vol. 86, no. 10, 10, May 2002, pp. 1665–66. *www.nature.com*, <https://doi.org/10.1038/sj.bjc.6600309>.
- “Lung Cancer - Non-Small Cell - Statistics.” *Cancer.Net*, 25 June 2012, <https://www.cancer.net/cancer-types/lung-cancer-non-small-cell/statistics>.
- M, Król, et al. “Why Chemotherapy Can Fail?” *Polish Journal of Veterinary Sciences*, vol. 13, no. 2, 2010. *pubmed.ncbi.nlm.nih.gov*, <https://pubmed.ncbi.nlm.nih.gov/20731201/>.
- “MA03.02 TROPION-PanTumor01: Updated Results From the NSCLC Cohort of the Phase 1 Study of Datopotamab Deruxtecan in Solid Tumors.” *Journal of Thoracic Oncology*, vol. 16, no. 10, Oct. 2021, pp. S892–93. *www.sciencedirect.com*, <https://doi.org/10.1016/j.jtho.2021.08.118>.
- McLaughlin, Joseph, and Patricia LoRusso. *Antibody–Drug Conjugates (ADCs) in Clinical Development*. Nov. 2016, pp. 321–44. *onlinelibrary.wiley.com*, <https://doi.org/10.1002/9781119060727.ch13>.
- Nygren, Peter. “What Is Cancer Chemotherapy?” *Acta Oncologica*, Jan. 2001. world, *www.tandfonline.com*, <https://doi.org/10.1080/02841860151116204>.
- Siegel, Rebecca L., et al. “Cancer Statistics, 2024.” *CA: A Cancer Journal for Clinicians*, vol. 74, no. 1, Jan. 2024, pp. 12–49. *DOI.org (Crossref)*, <https://doi.org/10.3322/caac.21820>.
- Sj, Keam. “Trastuzumab Deruxtecan: First Approval.” *Drugs*, vol. 80, no. 5, Apr. 2020. *pubmed.ncbi.nlm.nih.gov*, <https://doi.org/10.1007/s40265-020-01281-4>.
- Sung, Hyuna, et al. “Global Cancer Statistics 2020: GLOBOCAN Estimates of Incidence and Mortality Worldwide for 36 Cancers in 185 Countries.” *CA: A Cancer Journal for Clinicians*, vol. 71, no. 3, May 2021, pp. 209–49. *PubMed*, <https://doi.org/10.3322/caac.21660>.
- “Treatment of Stage III Non-Small Cell Lung Cancer: Diagnosis and Management of Lung Cancer, 3rd Ed: American College of Chest Physicians Evidence-Based Clinical Practice Guidelines.” *Chest*, vol. 143, no. 5, May 2013, pp. e314S–e340S. *www.sciencedirect.com*, <https://doi.org/10.1378/chest.12-2360>.
- Zopf, Y., et al. “Women Encounter ADRs More Often than Do Men.” *European Journal of Clinical Pharmacology*, vol. 64, no. 10, Oct. 2008, pp. 999–1004. *PubMed*, <https://doi.org/10.1007/s00228-008-0494-6>.

## **Daniel Inouye: Personal Justice Attained by Iris Lu**

Daniel Inouye was 17 years old when he witnessed Japanese planes bomb Pearl Harbor. That day would “go down in infamy” for the US— and be life-altering for Inouye. In the wake of the attack, Inouye wanted to join the US military to fight back— but found he was ineligible to serve: the US War Department had reclassified all Japanese Americans as “Enemy Aliens” (PBS, *The War – Daniel Inouye*). This wave of suspicion and xenophobia would culminate with FDR’s signing of Executive Order 9066, which sent over 120,000 Japanese Americans to internment camps (HISTORY -- *How Japanese Americans Fought for—and Won—Redress for WWII Incarceration*).

Inouye petitioned the government to lift the ban and allow him to fight. In need of reinforcements, the War Department conceded, allowing Inouye to enlist in the 442nd Infantry Regiment Combat Team of Nisei fighters. Over two years of deployment in Europe, Inouye would be shot in the stomach and lose an arm in the service of the country that he had fought to fight for. But despite fighting honorably, Inouye and his peers in the 442nd regiment returned home to the same discrimination as when they left. Inouye would later recall walking into a barbershop in San Francisco decorated with medals and being told “We don’t serve Japs.” (DKII, *Senator Daniel Inouye & Family: Watergate Changed his Life*).

In 2013, a year after his passing, Daniel Inouye became the first and only senator to receive both the Medal of Freedom and the Medal of Honor. Ostensibly, these medals were for the courage he showed on the battlefield. But Inouye’s greatest act of courage would come when he returned home, fighting to ensure the violation of constitutional rights suffered by Japanese Americans during the war never happened again.

In 53 years of representing his home state of Hawaii Inouye was a consistent champion for democratic values, from his keynote at the 1968 Democratic National Convention where he warned against the dangers of suspicion and fear, to his seat on the Senate Select Committee investigating Watergate, where he cautioned the importance of safeguarding the election process and voter rights. These fights were not without a price. As the highest ranking Asian American member of congress, he was often met with the same vitriol he endured in the 1940s. “My son... used to enjoy answering the phone. But [now] I grab the phone, because...there are [phone calls] that are rather hateful.

In 1978, Inouye began the most important chapter in his battle for civil rights: working with the Japanese American Citizens League (JACL) as a leader of the Redress Movement. The movement faced many challenges, beginning with divisions within the JACL itself. Haunted by their own moral shortcomings during WWII, many of the elder Nisei members were content to move on, popularizing words like *shikataganai* (“it can’t be undone”) (Japanese American Redress). The 3rd generation Sansei, on the other hand, recognized internment within the context of the broader civil rights movement (NPR, *The Unlikely Story Behind Japanese Americans fight for reparations*), and believed reconciliation was essential— but were split between

demanding a federal apology and demanding both an apology and monetary compensation. (Maki, *How Japanese Americans Fought for—and Won—Redress for WWII Incarceration*).

Redress also faced challenges from conservative revisionists like Lillian Baker, whose group Americans for Historical Accuracy claimed internment camps never existed, claimed pictures of the camps had been doctored, and argued its internees had been there voluntarily.

With a quiet courage that reflected his years of experience, Inouye realized the only way to move forward was to manifest a common, objective truth, suggesting “a federal commission to research and investigate the incarceration experience” (Maki, *How Japanese Americans Fought for—and Won—Redress for WWII Incarceration*). On August 2, 1979, Inouye co-sponsored Senate bill 1647 to form the Commission on Wartime Relocation and Internment of Civilians (CWRIC).

After two years the CWRIC released its report, “Personal Justice Denied,” which chronicled the injustices suffered by Japanese-Americans during the war. The report elicited testimony from 750 witnesses across 10 US cities, with many sharing their stories for the first time. The report concluded internment was not done out of “military necessity” that had been claimed to defend Executive Order 9066, but from “race prejudice, war hysteria, and a failure of political leadership”

Inouye’s seniority in the senate helped rally support for the commission’s recommendations— as did his role as Chairman of the Senate Select Committee on Secret Military Assistance to Iran and the Nicaraguan Opposition in the Summer of 1987. In his closing statement in the Iran Contra hearings, Inouye was discussing the abuse of power within the Reagan administration, but could just as well have been describing the dangerous logic that had led to Japanese internment: “‘This is a dangerous world,’ [the generals] said. That, my fellow citizens, is an excuse for autocracy, not for policy. Vigilance abroad does not require us to abandon our ideals or the rule of law at home. On the contrary, without our principles and without our ideals, we have little that is special or worthy to defend” (DKII, *Iran-Contra Hearings Closing Statement*). Just one month after Inouye cautioned of the dangers of autocracy in the Iran Contra hearings, a bill to enact the CWRIC’s recommendations--named HR 442 in honor of the Nisei regiment in which Inouye served--came to the floor of Congress.

On August 10, 1988, President Reagan signed the Civil Liberties Act into law, granting a presidential apology and redress payments of \$20,000 to every living Japanese American who had been affected by Executive Order 9066. (HISTORY, *How Japanese Americans Fought for—and Won—Redress for WWII Incarceration*). For Inouye, the bill was the culmination of almost 50 years fighting for democratic values both on and off the battlefield, righting not only the wrongs perpetrated against Japanese Americans, but serving as a reminder to protect the constitutional rights of all Americans. Today, against a rising tide of antidemocratic forces, the courage of leaders like Daniel Inouye must inspire us to fight abuses of power in the face of hysteria and fear, and make sure that democracy, universal suffrage, and equity remain a reality for all Americans.

# How the Association of Soil Quality with Economic Stratification Affects Sustainable Landscaping

## By Romir Jain

### Abstract

Central Texas's local freshwater reservoirs have a capacity of 35%, making freshwater more valuable. The strain on our local freshwater resources will increase with more extreme droughts, rising temperatures, and urban growth. 30% of domestic water use by the average American household goes into lawn maintenance. Still, a large portion of that water is wasted due to inefficient irrigation systems, high water-demanding plant species, and the unawareness of its detrimental effects. An excellent way to mitigate the strain on the local water supply and adapt to our rapidly changing climate is to embrace sustainable practices in landscaping, such as xeriscaping, and fostering the use of native plants. Native plants are drought-resistant, requiring less mowing and watering, and they are best suited for the environment where they originate. This research initiative seeks to gauge the willingness of citizens to adopt financial incentive policies for sustainable landscaping, such as native plant rebates, as well as determine native plant productivity in the different districts of Austin, Texas. The investigation will encompass an assessment of the public's awareness of existing incentive programs, an exploration of potential supplementary incentives, and a comparative analysis of incentives offered by other cities. We will conduct soil tests (PH, Nitrate, Water Retention, and Porosity) to determine soil quality. We will use the remaining soil to plant Texas native wildflower seeds and monitor their growth. We hope to understand the variability of soil quality and how blocking by district can illuminate the differences in socioeconomic status.

### Introduction

Central Texas, specifically the Austin Metropolitan Area, is one of the fastest-growing

regions in America in terms of population—the Austin Area projects to have more than 4 million people by 2060. With hundreds of thousands of people coming in (*Austin Open Data Portal, 2024*), we must accommodate and ensure every resident can access plentiful freshwater. However, our local freshwater resource, Lake Travis, has recently dropped to 40% capacity (*Water Data For Texas, 2024*). This poses a risk to our freshwater security amidst record-breaking drought levels. As our reservoirs are depleted, the aggregate freshwater consumption behavior remains unchanged, with landscaping (*Texas Water Development Board, 2024*) being the leading use for water consumption. 80%-90% of the water outdoors is dedicated to maintaining lawns, gardens, and plants (*EPA, 2023*). Mitigation is the first step to combat the increasing risk of water scarcity in Central Texas. Native Plants are drought-resistant (*Rushing, 2020*) and, therefore, can be a simple solution to many homeowners' lawns. Native plants are adapted to the local climate, soil, and ecosystem. This adaptation makes them an eco-friendly and practical option for homeowners looking to reduce their water usage and maintenance costs (*Shelef, 2017*). By replacing non-native turf grass with indigenous plants, homeowners can create a haven for diverse plants. Native plants are the best at providing food and shelter to other native species, and by promoting biodiversity (*Bick, 2017*), the ecosystem becomes more sustainable. Maintaining a traditional lawn can be time-consuming, labor-intensive, and expensive. Constant mowing, watering, and fertilizing require a lot of effort and resources. In contrast, native plant landscapes are typically low maintenance. Once established, native plants require minimal attention and water (*Bick, 2017*). They are self-sufficient and able to withstand droughts and temperature fluctuations (*Lawns Go Wild, 2023*). This results in significant savings in time, water, and money. Even with



these benefits, however, homeowners view the change in their lawn as an inconvenience. Precisely because of the financial and time requirements. Why would someone want to pay money and spend time and effort making an aesthetically marginal change to native grass? This is why the Austin, Texas Government has offered financial incentives for landscaping in hopes of shifting city-wide sentiment. The most famous, the Waterwise Landscape Rebate Program, offers up to \$3,000 to homeowners for converting turf grass into native grass (*austin.texas.gov, 2023*).

The Landscape Survival Tools rebate provides up to \$120 on mulch, compost, and core aeration. Austin Water's WaterWise Rainscape Rebate helps residents and schools install landscape features (berms, terraces, swales, rain gardens, porous pavement, etc.) to keep rainwater on the property up to \$1500 (*austin.texas.gov, 2023*). Despite the easy accessibility of the financial cash-back system, there seems to be low awareness of the rebates. Also, there disproportionately appear to be more households utilizing the rebate from the wealthier districts of Austin (6, 8 and 10 out of 10 total districts) (*City of Austin Data Portal, 2024*). This imbalance suggests a need for targeted outreach and education to ensure that all communities, regardless of socioeconomic status, can benefit from these incentives. The goal of this program is not to provide tax write-offs to the wealthy but to encourage a sustainable future. By providing awareness to other districts of Austin for the landscaping incentives, we can see an aggregate shift in lawn maintenance.

### ***Blocking by District - Economic Stratification***

In this study, we examine how the growth and productivity of native plants might vary across different districts in Austin, Texas, considering the possible relationship between soil quality and socioeconomic status. This

approach, "Blocking by District," helps us understand why native plants might thrive in some areas more than others. The basis for our investigation is that soil quality, essential for plant growth, can differ significantly between districts (*Shukla, 2006*). These differences are often linked to the variance in median household incomes for homeowners in these districts (*Herrick, 2000*). For instance, wealthier areas (District 6) might have better resources and more access to services that improve and maintain soil, which can enhance plant growth. They tend to water their lawns more, have access to third-party lawn care, and have more determination to set sight of a green, clean-cut lawn.

In contrast, less affluent districts may struggle with poorer soil quality due to limited access to lawn care resources, making it harder for plants to grow. This study also looks at the differences in soil quality between different socioeconomic regions of Austin to see their ability to facilitate the growth of native plants and embrace sustainable landscaping. This will help determine the feasibility of restructuring current financial incentives to suit all citizens of Austin better. It's likely that residents in wealthier districts are not only more aware of these incentives but may also be more likely to use them (*Williams, 2022*). This could lead to unequal adoption of sustainable landscaping practices across different areas, overruling the purpose of these rebates (*Rennen 2013*), which is to provide equitable incentives to contribute to the city's sustainability on aggregate and not just see fluctuations in the utilization of potential tax breaks from the affluent. By analyzing these factors, we aim to identify patterns and suggest ways to improve the effectiveness of policies promoting native plants and sustainable landscaping. This will help make Austin's urban planning more sustainable and equitable, supporting better water conservation and environmental resilience citywide. This approach addresses the scientific aspects of plant growth and integrates the social dimensions, which are crucial for successfully implementing urban

ecological policies.

### Soil by District - Soil Quality

Given the disproportionate adoption of native plant and waterwise landscaping incentive policies within each district of Austin, Texas (*austin.texas.gov, 2023*), it is vital to understand the genuine effectiveness of the policy. By understanding the variability of soil quality, we will compare all results. There are many indicators of soil quality, but in this situation, understanding nitrate, phosphate, PH, and soil composition can reflect each soil sample's ability to facilitate the growth of Texan seeds of native wildflowers (*Shukla, 2006*). Understanding nitrate and phosphate levels, pH balance, and soil composition is crucial, as these elements are vital indicators of soil fertility and overall health. This analysis will provide a detailed landscape of soil health across Austin, highlighting specific districts where soil conditions may not be conducive to the growth of native species without significant amelioration. Furthermore, suppose soils in less affluent districts are found to be particularly poor. In that case, incentives might include not only rebates for planting native species but also support for soil improvement measures such as the addition of organic matter or pH adjusters (*Herrick, 2000*).

This holistic approach will allow us to assess and enhance the effectiveness of our urban environmental policies, ensuring they are equitable and based on each district's specific environmental and socioeconomic contexts. Through this study, we aim to foster a more inclusive and effective strategy in promoting sustainable landscaping practices across Austin, turning ecological insights into actionable, impactful urban policy.

### Soil Sampling Methodology

For this research, ten soil samples were

needed from each district of Austin, Texas. These soil samples were sampled from Austin Government-regulated municipal and metropolitan parks on the same day. The goal was to limit the variability between soil samples and ensure confounding factors do not affect soil quality results. Following the guidance of Matt Fryer, soil instructor for the University of Arkansas System Division of Agriculture (*Fryer, 2019*), we adopted a soil sampling procedure tailored to the needs of our study. After locating specific parks in each Austin District, we recognized that each area might exhibit distinct soil properties due to varying levels of urbanization, socioeconomic factors, and historical land use.



*Districts of Austin, Texas; austintexas.gov*

This stratification-classification into different groups is similar to separating a landscape into different sections for sampling, as suggested by Fryer, where each section might have differing soil characteristics due to the type of vegetation or the visual performance of the plants (*Fryer, 2019*). Our sampling methodology used a clean soil probe, ideal for obtaining a uniform soil core at the recommended depth. This tool allows us to collect consistent samples across all districts without over-representing surface soil nutrients, which can skew results (*Fryer, 2019*).

Inaccuracies in sample depth can lead to overestimations of soil fertility. We removed any surface organic matter, like mulch or rocks, before inserting the soil probe into the ground. We collected multiple cores in each park using a zig-zag pattern across the park landscape to ensure that the samples represented the entire area. We sampled multiple areas in the park to ensure each soil sample represented the park.

District	Park
1	Rosewood Neighborhood Park
2	Dove Springs District Park
3	Roy G. Guerrero Colorado River Metro Park
4	Quail Creek Neighborhood Park
5	Longview Neighborhood Park
6	Dominion at Great Hills Park
7	Walnut Creek Metro Park
8	Zilker Metropolitan Park
9	Butler Shores at Town Lake
10	Oak View Neighborhood Park

Table 1: List of Soil - Sampled Parks

Furthermore, we avoided areas of the park

that seemed to contain high human involvement, as the results could skew nitrate, phosphate, and PH content due to fertilizer application by park maintainers(Thomas,1996). This is crucial as soil nutrients vary significantly even within a small area( Herrick, 2000). After collecting all soil cores, we mixed them thoroughly in a clean plastic bucket, removed any lingering rocks or organic debris, and then filled labeled zip-top bags with one pint of soil from each sample area. Labeling was done at the start to ensure each sample could be accurately traced back to its specific district and sampling location. These samples were then submitted for analysis, where they were tested for pH levels, nitrate and phosphate content, and overall soil composition.

### 3. Soil pH Levels

The success of native plants in urban environments heavily depends on the congruence between the soil pH and the pH requirements of the plants(Thomas,1996), which are often finely tuned to their native habitats. By identifying districts where the soil pH deviates from the ideal range for native plants, targeted amendments can be implemented. These adjustments are crucial for these plants' survival and ensuring sustainable landscaping policies are effective and equitable across the city.

### 4. Soil Composition Analysis

The composition of the soil, particularly the balance of sand, silt, and clay, plays a pivotal role in determining its texture, affecting water drainage, nutrient retention, and root development( Blake, 1989). Loam soils, which represent an ideal balance of these three components, are well-suited for growing a wide range of Texas wildflowers and native plants due to their excellent drainage and nutrient-holding capabilities (Bogunovic, 2014). This study will delve deeper into the soil composition of each district within Austin to identify the predominant soil types—be it sandy loam, silty loam, or clay loam—and their distribution. Understanding the soil texture will allow for targeted soil

management strategies to convert less-than-ideal soil conditions into fertile loam or loam-like textures.

### 5. Nitrate Content Evaluation

Nitrates, as indicators of soil fertility, profoundly impact plant health and growth. Adequate nitrate levels are essential for plant development, affecting everything from leaf growth to flower production (Shukla, 2006). We will assess nitrate levels across various districts in Austin to determine if the soils have naturally adequate fertility or if they require external inputs.

District 9 (Central Austin)	\$91,264
District 5 (South Central Austin)	\$93,872
District 7 (North Central Austin)	\$103,981
District 6 (Northwest Austin)	\$111,334
District 8 (Southwest Austin)	\$126,375
District 10 (West Austin)	\$135,568

Table 2: City of Austin Open Data Portal and Austin Census Reporter

### 6. Phosphate Content Assessment

Phosphates are crucial for the energy processes of plants, including photosynthesis and energy storage (Shukla, 2006). Areas with phosphate deficiencies might be experiencing suboptimal plant health, which could reduce the effectiveness of the adoption of native plant initiatives. Addressing these deficiencies through targeted interventions, such as applying appropriate fertilizers or organic amendments, could significantly enhance plant vitality and ecosystem health.

### Household Incomes By District (Low to High)

District	Median Household Income (\$)
District 3 (East Austin)	\$58,489
District 4 (North Austin)	\$60,756
District 1 (Northeast Austin)	\$62,788
District 2 (Southeast Austin)	\$78,554

Given the high-income disparities in the city (Table 2, 2024) of Austin, our soil tests will provide us with an understanding of their ability to facilitate the growth of native plants. Table 2 dramatically illustrates the economic diversity across the city. Income levels profoundly influence access to resources, including high-quality soil management services, which can lead to significant differences in the conditions and potential for sustainable landscaping across various districts (Acquaye, 2011). Affluent areas often enjoy superior landscaping services, regular soil amendments, and chemicals for fertile soil and diverse plant life. In contrast, lower-income districts may suffer from poorer soil quality due to limited access to such enhancements, pursuing compacted, nutrient-depleted soils that are less supportive of native plant growth (Acquaye, 2011). This disparity affects the physical landscape and the feasibility of adopting sustainable practices such as native landscaping, which is crucial for urban biodiversity and ecological resilience. Given this context, equitable utilization of native plant rebates and incentives becomes vital. Wealthier districts typically exhibit higher participation rates in rebate programs due to better initial conditions

and greater awareness, making the transition to native landscaping feasible and attractive in the hopes of tax breaks and household value appreciation (City of Austin Data Portal, 2024). For lower-income districts, barriers such as poor soil conditions and the associated costs of necessary soil improvements can make participation in such programs less accessible. To address these disparities, the city must implement targeted educational outreach and enhanced rebate programs that specifically support soil improvement in economically disadvantaged areas. This strategy ensures that all residents, regardless of economic status, can improve their soil quality and participate in sustainable landscaping initiatives. This is not only an environmental imperative but also a financial strategy; native plants, once established, require less water, fertilizer, and maintenance, translating into substantial savings for households (Herrick, 2000), especially those in lower-income brackets. Furthermore, income levels can also influence the maintenance and soil quality in parks and community spaces, where higher-income areas may see more investment in park upkeep (Acquaye, 2011). This includes regular soil testing and applying soil amendments, ensuring these public spaces remain vibrant and welcoming. Parks in lower-income areas, by contrast, might not receive the same level of care, resulting in degraded soil conditions that limit the growth of native vegetation and reduce the overall usability of these spaces.



To understand soil composition, we used Alum (potassium aluminum sulfate), a food preservative, among other applications. But, alum can also play a role in clarifying the process of sedimentation in soil analysis. Alum can split the soil into three components: silt, sand, and clay, allowing us to measure each concentration with true magnitudes.

### Soil Tests

We employed the Akasha Soil Test Kit to conduct comprehensive soil analyses. This kit is particularly suited for our needs because it provides detailed and reliable results for various soil health indicators, including pH, nitrate, and phosphate. Each test came with capsules, instructions, coloring sheets, and ten tablets per test (phosphate, PH, and Nitrate).



### Procedure for Nitrate Content

We utilized a structured procedure with the nitrate test kit to ensure accuracy and consistency in our measurements. We begin by collecting the nitrate test kit from its storage in a Ziplock bag, which helps keep the kit organized and clean. The samples are prepared through a process of drying, grinding, and sieving to ensure they have a consistent and fine texture necessary for effective testing. The soil is then mixed with distilled water at a 1:5 soil to water ratio. The testing process starts by using a pipette to transfer the soil water into the capped test tube. A Nitrate tablet is then added to the tube, which is capped and shaken vigorously until the tablet completely dissolves, thoroughly mixing the reagent with the solution. After shaking, the solution is allowed to sit undisturbed for 10 minutes, a necessary step for the color development that is critical for nitrate quantification. Once the reaction time has elapsed, the resulting color of the solution is compared to a nitrate color chart provided in the kit. This comparison determines the

concentration of nitrates present in the soil. The measured value is then recorded accurately on a data table.

### Procedure for Phosphate Content

Here's how we carried out the phosphate testing process using the provided test kit: We take a soil sample from the designated areas within each district, ensuring it accurately represents the local soil conditions. We add distilled water at a 1:5 ratio of soil to water to prepare the sample for testing. This preparation step is critical as it allows the soil particles to interact with the water, releasing any phosphates into the solution. After adding water, we stir the mixture for about 30 seconds to ensure thorough mixing. This step is crucial for suspending the soil particles and ensuring the phosphates dissolve into the water. Once mixed, the solution must settle, which can take up to 10 minutes, especially for soils with a higher clay content. This settling phase is necessary to allow the larger particles to sink, leaving a clearer solution above that is better suited for testing. Next, we proceed to fill the test tubes provided in the kit. Using the pipette included in the kit, we carefully draw the clear supernatant from above the settled soil and fill each of the three test tubes up to the fourth line marked on their sides. Using only clear liquid is important to avoid any sediment that might skew the results.

Once the test tubes are filled, we open each phosphate test capsule provided with the kit and carefully pour its contents into a test tube. After adding the capsules, we replace the caps on the test tubes and shake them vigorously. This action ensures the contents of the capsules fully dissolve and react with the water sample, a necessary step for developing the color indicative of phosphate presence.

PLANT FOOD CHART		
Nitrogen	Phosphorous	Potash
High	High	High
Medium	Medium	Medium
Low	Low	Low
Very Low	Very Low	Very Low

### Procedure for PH Test

We begin the testing process by collecting a representative soil sample from each designated area within the various districts, ensuring that the samples accurately reflect the local soil conditions. We scooped enough soil from each sample to fill up the first line of the test tube provided in the pH testing kit. This amount is critical as it ensures consistency in the volume of soil tested across all samples, which is essential for accurate pH measurement. We carefully open a pH testing capsule once the soil is in the test tube. These capsules contain a specially formulated reagent that reacts with the soil to indicate pH levels.

We add one capsule's contents to the test tube containing the soil. After adding the capsule, we fill the test tube with water up to the fourth line. This specific volume of water is necessary to properly dissolve the capsule's contents and interact with the soil. Following the shaking, we allow the test tube to sit undisturbed for approximately 30 minutes. This resting period lets the color fully develop, which is essential for accurately assessing the soil's pH. The color that develops during this time indicates the soil's acidity or alkalinity. Once the color has developed, we compare the

color of the solution in the test tube to the color chart included in the pH test kit. The Aksha testing kits provide a numerical estimate of the PH, which can be considered a data point. This chart provides a range of colors corresponding to different pH levels, allowing us to determine the exact pH of the soil sample. We can accurately assess the soil's pH level by matching the color in the test tube to the closest color on the chart.

Any pH between 6.5 and 7 shows a healthy soil that can facilitate the growth of native Texas Wildflower seeds, including, but not limited to, Bluebonnets, pink ladies, Indian blankets and paintbrushes, and sunflowers. However, we will notice that some soils are different in acidity.

Soil acidity, shown by pH levels, varies for several reasons. Soils might be naturally acidic in places with lots of rain because the water washes away essential minerals like calcium and replaces them with acidic components like hydrogen. This is common in older, well-weathered soils found in humid areas. Human actions can also make soil more acidic, especially when using too much nitrogen fertilizer, which adds more acidic elements to the soil. On the other hand, soils in dry areas tend to be less acidic because there isn't enough rain to wash away the minerals that prevent acidity. Also, using a lot of lime to decrease soil acidity or overusing fertilizers rich in phosphorus can make the soil less acidic by increasing the pH. Knowing why soil pH levels change is important for growing plants well because the acidity or alkalinity of the soil affects how plants get nutrients, the health of soil microbes, and the overall condition of the soil (*Thomas, 1996*).



The results from this pH testing are carefully recorded and analyzed along with other soil characteristics. Understanding the pH levels across the different districts helps us evaluate the suitability of each area's soil for supporting native plants. Suppose the pH is found to be too acidic or alkaline for native plant species. In that case, we can recommend appropriate soil amendments to correct the pH, thereby enhancing plant health and promoting more sustainable landscaping practices.

## Procedure for Soil Composition Test

The procedure for analyzing soil composition is important for understanding the interaction between soil texture and plant growth. To assess the proportions of sand, silt, and clay in soil samples, we collect three spoonfuls of soil using a plastic spoon, which are then added to a plastic snap-seal vial.

The vial is gently tapped on a table or countertop to pack the soil and eliminate air spaces, ensuring consistency in the sample volume. Next, a quarter spoonful of Alum is added. This substance acts as a flocculant, helping soil particles settle more quickly, which is crucial for accurate layer measurement. However, not exceeding this amount is necessary to avoid skewing results. Following this, 40 mL of distilled water is carefully added to the vial, which is then sealed tightly to prevent leaks and shaken vigorously for two minutes to ensure thorough mixing. This step is essential for evenly dispersing the Alum and soil throughout the water, allowing for clear stratification of the soil layers once settling occurs. The vial is then placed on the lab table in a stable, undisturbed location. After one minute, the height of the sand layer settled at the bottom is measured and recorded. At the 15-minute mark, the height of the combined sand and silt layers is measured, with the previously recorded sand height subtracted to determine the silt layer alone. After 30 minutes, the total height of the column of clay, sand, and silt layers is recorded. The clay layer is determined by subtracting the heights of the sand and silt layers. These heights are then divided by the total height and multiplied by 100 to calculate the percentage of each soil component. Finally, these percentages are used with a soil triangle to determine the specific soil type, which is recorded on the datasheet. This detailed process provides insights into the soil's textural class. It informs us about its suitability for various types of plant growth, guiding



sustainable landscaping practices across Austin's diverse urban landscape.

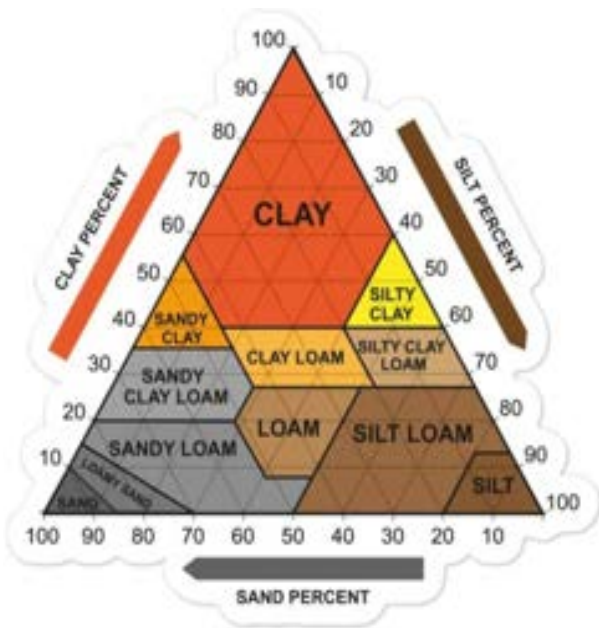

### Findings for Nitrate Test



The findings from the nitrate tests across Austin's districts show that there's no clear link between income levels and nitrate content in the soil. Despite varying income levels from \$58,489 to \$135,568, the nitrate levels ranged from very low to high without a consistent pattern related to the economic status

of the areas. This lack of a direct relationship might be surprising, but several factors can explain it. First, the widespread availability of nitrate-based fertilizers makes it easy for residents or caretakers in any district to enhance their soil nitrate levels, regardless of their income. These fertilizers are relatively inexpensive and widely accessible, allowing even lower-income households or community gardens to boost soil fertility effectively (Byrnes, 1990).

Additionally, other local practices and environmental factors could play a role. For instance, urban gardening projects, local parks management, or previous land use can significantly influence soil nitrate levels (Byrnes, 1990). Areas with active community gardening initiatives might have higher nitrate levels due to regular fertilization practices. In comparison, areas without such engagement might show lower levels, independent of the economic status of the residents. Moreover, the mobility of nitrates in the soil means they can be easily washed away by rain or irrigation, leading to fluctuating levels over time (Sebilo, 2013). This variability makes it difficult to establish a steady, predictable pattern of nitrate distribution based solely on income.



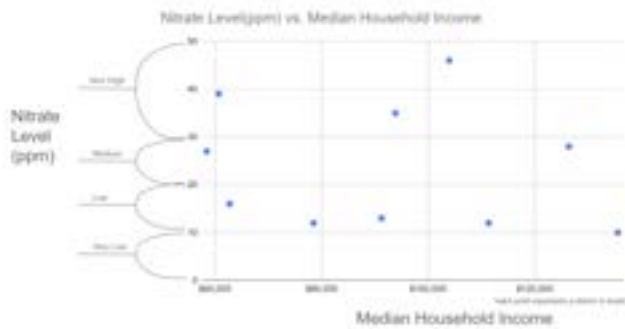

**Findings for Phosphate Test**



Effective water management practices common in well affluent neighborhoods can enhance how well phosphates are absorbed and retained in the soil. Proper irrigation not only supports plant growth but also optimizes soil moisture, which can improve phosphate uptake (Shuman, 2003). These factors suggest that economic status can significantly influence the ability and likelihood of enhancing and maintaining soil fertility through phosphate use. This highlights the need to consider socioeconomic variables in urban agricultural and greening initiatives to ensure equitable access to resources that promote soil health and plant vitality.

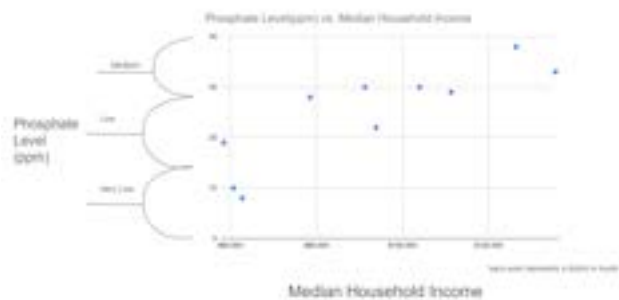

The data from various districts in Austin indicates a positive trend, where higher-income areas generally exhibit higher phosphate levels in the soil. This correlation can likely be attributed to several interrelated factors. First, residents in wealthier neighborhoods typically have better access to gardening resources, including high-quality fertilizers that contain phosphates along with nitrate (Shuman, 2003). These residents often invest more in their property's landscaping, regularly incorporating phosphate-rich fertilizers to enhance both the aesthetic and health of their gardens, which naturally leads to higher soil phosphate levels. Well-maintained public parks and green spaces often characterize higher-income districts. These areas receive regular maintenance, including systematic applications of fertilizers, to keep the vegetation healthy and visually appealing. Such consistent care contributes to the accumulation of phosphate in the soil.

Median Income	Phosphate Level (ppm)	Phosphate level
\$58,489	19	medium
\$60,756	10	low
\$62,788	8	low
\$78,554	28	medium
\$91,264	30	high
\$93,872	22	medium
\$103,981	30	high
\$111,334	29	medium
\$126,375	38	high
\$135,568	33	high

Table 3: Phosphate Results

## Discrepancies with Reasonings in Phosphate and Nitrate Tests - Why?

The discrepancies between the nitrate and phosphate test results across different income levels in Austin could be attributed to various environmental and human factors that differently affect the distribution and retention of these nutrients in the soil. While phosphate levels showed a clear trend of increasing with income, nitrate levels did not follow a similar pattern, suggesting that different mechanisms influence their presence in the soil. Phosphates, due to their less mobile nature in soil, tend to accumulate over time in places where regular fertilization occurs, such as in higher-income neighborhoods where landscaping practices are more intensive (Sebilo, 2013). This results in a buildup of phosphates in the soil, which the test results reflected. On the other hand, nitrates are highly mobile and can easily leach away with rain or irrigation water. This makes their presence in the soil more variable and less dependent on long-term accumulation, which might explain the lack of a consistent income-related trend in nitrate levels. Additionally, the application of nitrogen fertilizers can vary seasonally and be more responsive to immediate gardening and agricultural needs than phosphate fertilizers, which are often applied less frequently.

Furthermore, different soil management practices, such as the type and frequency of fertilization and local environmental conditions like drainage and precipitation patterns, can influence the accumulation and depletion of nitrates and phosphates differently.

### PH Test Results

Median Household Income vs PH

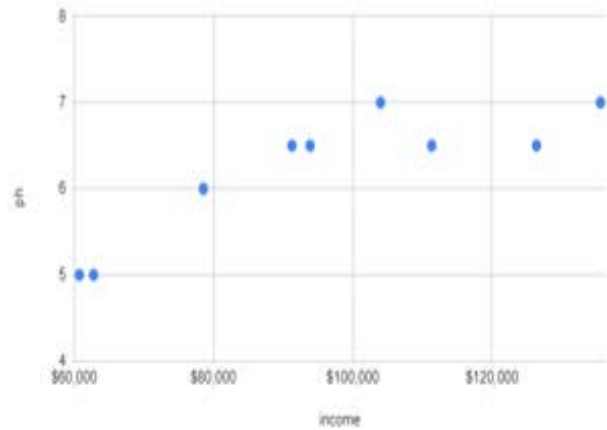

The pH test results across different income levels in Austin show a subtle upward trend, where higher-income districts generally exhibit slightly higher soil pH values. This data suggests that soil alkalinity might increase with income, although the variations are relatively minor. Several factors can explain this trend. First, using garden lime or alkaline fertilizers, common practices to manage lawn and garden health, can increase soil pH (Thomas, 1996). Higher-income households often invest more in landscaping services and may use these products more frequently or in higher quantities to enhance the appearance and health of their gardens.

Moreover, construction materials and urban debris, which can affect soil pH, might also contribute to these differences (Herrick, 2000). In wealthier areas, newer construction materials that

leach lime could influence the soil pH, making it slightly more alkaline. Despite these slight differences, the pH levels across all districts generally fall within a narrow range, suggesting that while economic factors can influence soil conditions, the effects on pH are not as pronounced as they might be with nutrients like nitrates and phosphates. This underscores the complexity of soil chemistry and the variety of factors that can influence pH levels in urban environments.



Median Household Income	PH
\$58,489	5
\$60,756	5
\$62,788	5
\$78,554	6
\$91,264	6.5
\$93,872	6.5
\$103,981	7
\$111,334	6.5
\$126,375	6.5
\$135,568	7

Table 4: PH Results

### Soil Composition Test Results

Median Household Income	Soil Composition
\$62,788	Silt loam
\$78,554	Loamy sand
\$58,489	Loamy sand
\$60,756	Sandy loam
\$93,872	Sandy clay loam
\$111,334	Silt loam
\$103,981	Clay loam
\$126,375	loam
\$91,264	Silt loam
\$135,568	loam

Table 5: Soil Compistion Results

The relationship between the average income of households and the type of soil found in different areas of Austin shows that soil varies a lot, regardless of how much money people make. For example, areas where households earn around \$58,489 and \$78,554 have "loamy sand," which drains water well but doesn't hold nutrients as tightly, meaning it might need more water and fertilizer to keep

plants healthy. As incomes slightly increase, like in areas earning \$62,788 and \$91,264, the soil type is mostly "silt loam." This soil is great for growing plants because it holds onto water and nutrients well without being too sticky or dense, making it a preferred choice for gardens and parks (*Black, 1989*).

In wealthier areas, where incomes are \$103,981, \$126,375, and \$135,568, you find "loam" and "clay loam" soils. These are often seen as the best types of soil. "Loam" balances sand, silt, and clay, making it ideal for most plants because it holds nutrients and water well but still drains nicely. "Clay loam" has more clay, so it's even better at holding nutrients and moisture, but it can be heavier and harder to work with. The district with an income of \$93,872 has "sandy clay loam," which is a mix but leans more towards having sand. This soil type is a middle ground, offering decent drainage and nutrient hold. While wealthier areas tend to have soil types considered better for gardening and farming, the variety of soils across different income levels shows that many factors influence soil type, not just how affluent an area is.

## **Conclusion**

The conclusion drawn from the research on the association between socioeconomic status and soil quality in Austin, Texas, highlights significant disparities that reflect broader societal inequities. The results from the soil tests reveal that lower-income areas tend to have poorer soil pH and phosphate levels. In contrast, the distribution of nitrate levels shows no clear correlation with income, indicating that nitrates are more readily influenced by factors such as the availability and use of nitrogen-based fertilizers, which can be accessed and applied regardless of

socioeconomic status. Poorer pH levels in lower-income areas suggest a lack of resources or knowledge necessary to amend and manage soil conditions effectively. This can affect the ability of plants to absorb nutrients and thrive, which in turn impacts the overall ecosystem health and the aesthetic and environmental quality of these neighborhoods. Similarly, the lower phosphate levels in these areas could indicate less access to or utilization of phosphate fertilizers, which are essential for robust plant growth. These findings underscore a crucial aspect of urban inequality: environmental disparities are often deeply intertwined with economic conditions. Lower-income communities not only face economic disadvantages but also bear the brunt of environmental degradation, which includes poorer soil quality. This inequity can limit their ability to engage in and benefit from sustainable practices such as xeriscaping and using native plants is more sustainable and cost-effective in the long term. Addressing the disparities in soil quality is a fundamental step toward rectifying broader environmental injustices. Improving soil quality in economically disadvantaged areas can help level the playing field, allowing all communities to participate in and benefit from sustainable landscaping practices. This enhances the urban environment and contributes to greater social equity. Efforts to educate communities about soil health, increase accessibility to soil amendments, and integrate soil improvement into broader urban planning and community development initiatives are essential. In conclusion, while the challenges are significant, the findings provide a clear directive for city planners, policymakers, and community organizations to prioritize soil health as a key element of environmental justice and urban sustainability. By addressing soil quality disparities, Austin can take a meaningful step towards ensuring that all its residents have the opportunity to live in healthy, vibrant, and sustainable environments.

[https://doi.org/10.1016/S0269-7491\(03\)00081-2](https://doi.org/10.1016/S0269-7491(03)00081-2).

## Bibliography

*Determining Soil Quality Indicators by Factor Analysis - ScienceDirect.*  
<https://www.sciencedirect.com/science/article/abs/pii/S0167198705001200>.  
Accessed 19 June 2024.

*Early-season Grazing of Native Grasses Offers Potential Profitable Benefit | Agronomy Journal.*  
<https://access.onlinelibrary.wiley.com/doi/abs/10.1002/agj2.20130>. Accessed 19 June 2024.

Byrnes, B. H. "Environmental Effects of N Fertilizer Use — An Overview." *Fertilizer Research*, vol. 26, no. 1, Dec. 1990, pp. 209–15. Springer Link, <https://doi.org/10.1007/BF01048758>.

Shuman, L. M. "Fertilizer Source Effects on Phosphate and Nitrate Leaching through Simulated Golf Greens." *Environmental Pollution*, vol. 125, no. 3, Oct. 2003, pp. 413–21. ScienceDirect,

*Historical Water Use Estimates | Texas Water Development Board.*  
<https://www.twdb.texas.gov/waterplanning/waterusesurvey/estimates/index.aspx>. Accessed 19 June 2024.

*Imagine Austin Population and Jobs Forecast.*  
<https://data.austintexas.gov/stories/s/Imagine-Austin-Population-and-Jobs-Forecast/j5a7-yk8d/>. Accessed 19 June 2024.

Whitmyer, R. W., and G. R. Blake. "Influence of Silt and Clay on the Physical Performance of Sand-Soil Mixtures." *Agronomy Journal*, vol. 81, no. 1, 1989, pp. 5–12. Wiley Online Library, <https://doi.org/10.2134/agronj1989.00021962008100010002x>.

Sebilo, Mathieu, et al. "Long-Term Fate of Nitrate Fertilizer in Agricultural Soils." *Proceedings of the National Academy of Sciences*, vol. 110, no. 45,

Nov. 2013, pp. 18185–89. [pnas.org](https://doi.org/10.1073/pnas.1305372110)

(Atypon),

[https://doi.org/10.1073/pnas.1305372](https://doi.org/10.1073/pnas.1305372110)

[110](https://doi.org/10.1073/pnas.1305372110).

Acquaye, Lucy. “Low-Income Homeowners

and the Challenges of Home

Maintenance.” *Community*

*Development*, vol. 42, no. 1, Jan. 2011,

pp. 16–33. Taylor and

Francis+NEJM,

[https://doi.org/10.1080/15575330.201](https://doi.org/10.1080/15575330.2010.491154)

[0.491154](https://doi.org/10.1080/15575330.2010.491154).

Thomas, G. W. “Soil pH and Soil Acidity.”

*Methods of Soil Analysis*, John Wiley

& Sons, Ltd, 1996, pp. 475–90. Wiley

Online Library,

[https://doi.org/10.2136/sssabookser5.3](https://doi.org/10.2136/sssabookser5.3.c16)

[.c16](https://doi.org/10.2136/sssabookser5.3.c16).

Herrick, Jeffrey E. “Soil Quality: An

Indicator of Sustainable Land

Management?” *Applied Soil Ecology*,

vol. 15, no. 1, Aug. 2000, pp. 75–83.

ScienceDirect,

[https://doi.org/10.1016/S0929-1393\(0](https://doi.org/10.1016/S0929-1393(00)00073-1)

[0\)00073-1](https://doi.org/10.1016/S0929-1393(00)00073-1).

Bogunovic, Igor, et al. “Spatial Variation

of Soil Nutrients on Sandy-Loam

Soil.” *Soil and Tillage Research*, vol.

144, Dec. 2014, pp. 174–83.

ScienceDirect,

[https://doi.org/10.1016/j.still.2014.07.](https://doi.org/10.1016/j.still.2014.07.020)

[020](https://doi.org/10.1016/j.still.2014.07.020).

*The Economics of Native Plants in*

*Residential Landscape Designs -*

ScienceDirect.

[https://www.sciencedirect.com/science](https://www.sciencedirect.com/science/article/abs/pii/S016920460500112X)

[/article/abs/pii/S016920460500112X](https://www.sciencedirect.com/science/article/abs/pii/S016920460500112X).

Accessed 19 June 2024.

Shelef, Oren, et al. “The Value of Native

Plants and Local Production in an Era

of Global Agriculture.” *Frontiers in*

*Plant Science*, vol. 8, Dec. 2017.

Frontiers,

[https://doi.org/10.3389/fpls.2017.0206](https://doi.org/10.3389/fpls.2017.02069)

[9](https://doi.org/10.3389/fpls.2017.02069).

*Water Data For Texas*.

<https://waterdatafortexas.org/reservoir>

[/individual/travis](https://waterdatafortexas.org/reservoir/individual/travis). Accessed 19 June

2024.

# A Comparative Analysis of Counting Systems in Goidelic and Brythonic Celtic Languages

Vishrut Mehrotra (student)<sup>1\*</sup>

1. Indus International School, Billapura Cross, Sarjapur, Bangalore, Karnataka, 562125, India

\* Corresponding author email: [vishrut.mehrotra@icloud.com](mailto:vishrut.mehrotra@icloud.com)



## Abstract

This study is a comparative analysis of the counting systems within the Goidelic and Brythonic branches of the Celtic languages, an Indo-European family comprising six extant languages. While Irish, Manx, and Scottish Gaelic constitute the Goidelic branch, Welsh, Cornish, and Breton form the Brythonic branch. Despite their common Proto-Celtic origins, these languages have evolved distinct features over time, influenced by historical migrations nearby cultures. This analysis aims to highlight the similarities and differences in the numeral systems of these 6 languages as well as their salient features.

## Keywords

Keyword 1 Linguistics; Keyword 2 Number Systems; Keyword 3 Celtic Languages; Keyword 4 Comparative Analysis; Keyword 5 Goidelic Languages; Keyword 6 Brythonic Languages.

## Introduction

The Celtic languages, members of the Indo-European family, comprise by six extant languages—Irish, Manx, and Scottish Gaelic which form the Goidelic branch, and Welsh, Cornish, and Breton which comprise the Brythonic branch (**Ball**) (**MacAulay**). Historically, these languages enjoyed widespread usage across the British Isles and the northwestern coast of France. Today however, of all the Celtic tongues, only Irish holds the distinction of being an official language of an independent nation, Ireland, and was also the 21st officially working language by the European Union in 2007 (**Hoyte-West**).

The Brythonic languages as well as the Goidelic languages trace their origins to early Celtic migrations, leading to the spread of the Brythonic languages across southern Scotland, Wales, Cornwall, and Brittany (**Jackson**). The migration of Brittonic people to the Armorican peninsula (Brittany) and the subsequent development of the Breton language are attributed to the influx of Anglo-Saxons to the British Isles. Meanwhile, Goidelic languages took root primarily in Ireland before being diffused to the Isle of Man and Scotland (**McEvoy et al.**).

The Goidelic and Brythonic Celtic languages exhibit a significant linguistic divergence stemming from their Proto-Celtic origins. Goidelic languages like Irish, Scottish Gaelic, and Manx are classified as Q-Celtic due to their retention of the Proto-Celtic \*k<sup>w</sup> phoneme, represented by a 'k' sound. In contrast, Brythonic languages such as Welsh, Breton, and Cornish are categorized as P-Celtic, characterized by the transformation of the \*k<sup>w</sup> sound into 'p'.

Both Brythonic and Goidelic language groups exhibit unique features, such as initial consonant mutations. These initial mutations involve word-initial or morpheme-initial consonant changes under the influence of a preceding word or morpheme. (**Willis**). Additionally, both language families demonstrate similar tendencies in their use of the verbal noun or infinitive constructions, wherein the verbal noun can perform the function of a finite verb. (**Fowkes**). Both groups also share a common lexical heritage with words of non-Indo-European origin found only in Brythonic and Goidelic (**Mikhailova**).

In addition, Goidelic and Brythonic branches exhibit nuanced similarities and differences in their counting systems, encompassing not just cardinal numbers but also ordinals. Despite both branches sharing a base-20 counting system (vigesimal), their syntax and morphology exhibit differences. While there has been some exploration of the differences and similarities between these two branches in other fields, research into how numbers are expressed in these languages is limited. This comparative analysis of counting systems in Goidelic and Brythonic languages aims to unravel this and highlight each system's distinguishing features.

## Cardinal Numbers in Goidelic Languages

Number	Irish (Gaeilge)	Scottish Gaelic (Gàidhlig)	Manx (Gaelg)
1	a haon	aon	nane
2	a dó	dhà	jees
3	a trí	trì	tree
4	a ceathair	ceithir	kiare
5	a cúig	còig	queig
6	a sé	sia	shey
7	a seacht	seachd	shiaght
8	a hocht	ochd	hoght
9	a naoi	naoi	nuy
10	a deich	deich	jeih
11	a haon déag	aon deug	nane-jeig
12	a dó dhéag	dhà dheug	daa-yeig
13	a trí déag	trì deug	tree-jeig
20	fiche	fichead	feed
21	fiche a haon	fichead 's a h-aon	feed nane
22	fiche a dó	fichead 's a dhà	feed jees
23	fiche a trí	fichead 's a trì	feed tree
30	tríocha, fiche a deich	trithead, deich air fhichead	treead, jeig as feed
40	daichead, dhá fhichead)	ceathrad, dà fhichead	daeed

50	caoga, dhá fhichead a deich	caogad, leth-cheud	queigad, jeig as daeed
60	seasca, trí fichid	seasgad, trí fichead	sheyad, tree feed
70	seachtó, trí fichid a deich	seachdad, trí fichead 's a deich	shiaghtad, tree feed as jeih
80	ochtó, ceithre fichid	ochdad, ceithir fichead	hoghtad, kiare feed
90	nócha, ceithre fichid a deich	naochad, ceithir fichead 's a deich	nuyad, kiare feed as jeig
100	céad	ceud	keead
200	dhá chéad	dà cheud	daa cheead
400	ceithre chéad	ceithir ceud	kiare keead
800	ocht gcéad	ochd ceud	hoght keead
1000	míle	míle	thousane

Adapted from Omniglot

## Cardinal Numbers in Byrthonic Languages

Number	Irish (Gaeilge)	Scottish Gaelic (Gàidhlig)	Manx (Gaelg)
Number	Welsh (Cymraeg)	Cornish (Kernewek)	Breton (Brezhoneg)
1	un (M) / un (F)	onan (M) / unn (F)	unan (M) / unan (F)
2	dau (M) / dwy (F)	dew (M) / diw (F)	daou (M) / div (F)
3	tri (M) / tair (F)	tri (M/F)	tri (M) / teir (F)
4	pedwar (M) / pedair (F)	peswar (M) / peswar (F)	pevar (M) / peder (F)
5	pump	pymp	pemp
6	chwech	hwegh	c'hwec'h
7	saith	seyth	seizh
8	wyth	eth	eizh
9	naw	naw	nav
10	deg	deg	dek

11	un ar ddeg	unnek	unnek
12	deuddeg	dewdhek	daouzek
13	tri ar ddeg	tredhek	trizek
20	ugain	ugens	ugent
21	un ar hugain	onan warn ugens	unan warn ugent
22	dau ar hugain	dew warn ugens	daou warn ugent
23	tri ar hugain	tri warn ugens	tri warn ugent
30	tri deg, deg ar hugain	tregens	tregont
40	pedwar deg, deugain	dew ugens	daou-ugent
50	hanner cant, deg a deugain	hanter kans	hanter-kant
60	chwe deg, trigain	tri ugens	tri-ugent
70	saith deg, deg a thrigain	dek ha tri ugens	dek ha tri-ugent
80	wyth deg, pedwar ugain	peswar ugens	pevar-ugent
90	naw deg, deg a phedwar ugain	dek ha peswar ugens	dek ha pevar-ugent
100	cant	kans	kant
200	dau gant	dew kans	daou c'hant
400	pedwar cant	peswar kans	pevar c'hant
800	wyth cant	eth kans	eizh kant
1000	mil	mil	mil

Adapted from Omniglot

## Comparison Between Goidelic and Brythonic Cardinal Systems

### **Base Systems**

Goidelic Languages incorporate both base-10 and base-20 systems in their numerals. In Irish, for example, *fiche* (20) and *dhá fhichead* (40, literally 'two twenties') showcase the

base-20 system. However 40 can also be called daichead in the base-10 system. In Scottish Gaelic, 50 can be called caogad as well as leth-cheud (literally 'half hundred').

On the other hand, Brythonic languages such as Cornish and Breton predominantly use a vigesimal (base-20) system for counting. For example, 60 in Cornish and Breton is tri ugens and tri-urgent (literally 'three twenties') respectively. Welsh, while historically vigesimal, now frequently uses a decimal system, especially in formal and educational contexts, making it an exception within the Brythonic branch. In Welsh, 50 is both hanner cant (literally, 'half hundred') and deg a deugain (literally, 'ten and fourty'), showcasing both a decimal and vigesimal system.

### ***Morphological Similarities***

Within each branch, numbers share morphological similarities:

- The number 1 in Irish (a haon), Scottish Gaelic (aon), and Manx (nane) shows clear linguistic kinship.
- The number 3 is a trí in Irish, trì in Scottish Gaelic, and tree in Manx.
- The number 4 across the Brythonic languages: Welsh (pedwar (M) / pedair (F)), Cornish (peswar), and Breton (pevar (M) / peder (F)) exhibit remarkable similarity, derived from a common Proto-Brythonic root.
- For 20, Welsh uses ugain, Cornish ugens, and Breton ugent.

### ***Use of Compound Forms***

Both the Goidelic and Brythonic branches of the Celtic languages exhibit the use of compound forms to construct larger numbers, especially within the vigesimal (base-20) system. For instance, in Irish, the number 65 is expressed as "trí fichid a cúig," which translates to "three twenties and five." This expression demonstrates how three groups of twenty are combined with an additional five. Similarly, 75 in Irish can be articulated as "trí fichid a cúig déag," meaning "three twenties and fifteen." Here again, the base-20 system is used to reach sixty (three twenties), and then fifteen is added on top.

The Brythonic languages, including Welsh, Cornish, and Breton, also exhibit this intricate use of compound forms for cardinal numbering. Welsh, for example, expresses 50 as "deg wyth ar hugain," which directly translates to "eighteen on twenty." Cornish and Breton follow a similar pattern.

### ***Gender Variations in Numerals***

A unique feature within some of these languages is the variation of numerals with gender, particularly noticeable in the Brythonic branch. For example, in Welsh, the numbers two, three, and four change form based on the gender of the noun they modify (e.g., dau (M) / dwy (F) for "two").

In Cornish, the numbers also exhibit gender variations:

- "onan" (masculine) / "unn" (feminine) for "one"
- "dew" (masculine) / "diw" (feminine) for "two"

Breton, too, shows gender distinction in its numbers:

- "unan" (masculine) / "un" (feminine) for "one"
- "daou" (masculine) / "div" (feminine) for "two"

Similar to Welsh, these variations help to match the numeral to the gender of the noun it is quantifying. This gender variation in numerals, applicable from numbers one to four, is a distinctive feature of the Brythonic languages, that is different from the Goidelic languages, where such gender distinctions in numbers are generally not made.

## Ordinal Numbers in Goidelic Languages

Number	Irish (Gaeilge)	Scottish Gaelic (Gàidhlig)	Manx (Gaelg)
1st	céad	ciad	kiad
2nd	dara	dara	nah
3rd	tríú	treas	treeoo
4th	ceathrú	ceathramh	kerroo
5th	cúigiú	còigeamh	queiggoo
6th	séú	sia(gh)amh	sheyoo
7th	seachtú	seachdamh	shiaghtoo
8th	ochtú	ochdamh	hoghtoo
9th	naoú	naoidheamh	nuyoo
10th	deichiú	deicheamh	jeihoo
11th	aonú déag	aonamh deug / h-aonamh deug	nane-jeigoo
12th	dóú déag	dàrna deug / dàrna deug	daa-yeigoo
13th	tríú déag	treasamh deug / an treasamh deug	tree-jeigoo
20th	fichiú	ficheadamh	feedoo
21st	fiche haonú	fichead 's a h-aonamh	feed as naneoo
22nd	fiche dóú	fichead 's a dhàrna	feed as daaoo
23rd	fiche tríú	fichead 's an treasamh	feed as treeoo
30th	tríochadú	tritheadamh	tree-feedoo

40th	daicheadú	dà fhicheadamh	daeedoo
50th	caogadú	caogadamh	queigadoo
60th	seascaú	seasgadamh	shey-feedoo
70th	seachtóú	seachdad(ach)amh	shiaght-feedoo
80th	ochtódú	ochdad(ach)amh	hoght-feedoo
90th	nóchadú	naochadamh	nuy-feedoo
100th	céadú	ceudamh	keedoo
200th	dhá chéadú	dà cheudamh	daa cheedoo
400th	ceathrú céadú	ceithir ceudamh	kiare cheedoo
800th	ochtú céadú	ochd ceudamh	hoght cheedoo
1000th	mílítheach	mileamh	thousaneoo

Adapted from Omniglot

## Ordinal Numbers in Byrthonic Languages

Number	Welsh (Cymraeg)	Cornish (Kernewek)	Breton (Brezhoneg)
1st	cyntaf	kynsa	kentañ
2nd	ail	eil	eil
3rd	trydydd	tressa	trede
4th	pedwerydd	peswora	pevare
5th	pumed	pymthek	pempvet
6th	chweched	hwetek	c'hwec'hvet
7th	seithfed	seytek	seizhvet
8th	wythfed	ethek	eizhvet
9th	nawfed	nawnsek	naved
10th	degfed	degthek	dekvvet
11th	unfed ar ddeg	unnekves	unnekvet
12th	deuddegfed	dewdhekves	daouzekvet
13th	trydydd ar ddeg	tredhekves	trizekvet
20th	ugeinfed	ugensves	ugentvet

21st	unfed ar hugain	onan warn ugensves	unan warn ugentvet
22nd	ail ar hugain	dew warn ugensves	daou warn ugentvet
23rd	trydydd ar hugain	tri warn ugensves	tri warn ugentvet
30th	degfed ar hugain	degves warn ugens	tregontvet
40th	pedwar deg deugainfed	dew ugensves	daougentvet
50th	pum deg hanner canfed	hanter kansves	hanter-kantvet
60th	chwe deg trigainfed	tri-ugensves	tri-ugentvet
70th	saith deg degfed a thrigain	degves ha tri ugens	dek ha tri-ugentvet
80th	wyth deg pedwar ugainfed	peswar-ugensves	pevar-ugentvet
90th	degfed a phedwar ugain	degves ha peswar ugens	dek ha pevar-ugentvet
100th	cantfed	kansves	kantvet
200th	dau gantfed	dew kansves	daou c'hantvet
400th	pedwar cantfed	peswar kansves	pevar c'hantvet
800th	wyth cantfed	eth kansves	eizh kantvet
1000th	milfed	milves	milvet

Adapted from Omniglot

## Comparison Between Goidelic and Brythonic Ordinal Systems

### **Base Systems**

Goidelic Languages incorporate only base-10 systems for their ordinal numbers. In Irish, for example, 30<sup>th</sup> is tríochadú in Irish, tritheadamh in Scottish, and tree-feedoo in Manx. On the other hand, Brythonic languages use both a vigesimal (base-20) system and a decimal (base-10 system) for ordinal number counting. For example, 60th in Cornish and Breton is tri-ugensves and tri-ugentvet respectively. Welsh, unlike cardinal numbers, uses a vigesimal system too. In Welsh, 70th is saith deg degfed a thrigain. However, the traditional ordinal numbers above 31 are not commonly used in colloquial Welsh.

### **Language-Specific Constructions**



In the Goidelic languages a straightforward method is typically used, where the base number is directly combined with an ordinal indicator to form ordinals. For example, the Irish ordinal number for 11th is "aonú déag," which directly combines "aon" (one) with "déag" (ten) and an ordinal suffix "-ú." Similarly, for 12th, "dóú déag" follows the same pattern, blending "dó" (two) with "déag." In Manx, a unique suffix "-oo" is added to denote ordinality, as seen in "nane-jeigoo" for 11th, where "nane" stands for one, and "jeig" for ten.

Conversely, the Brythonic languages often employ a combination of prepositional phrases and vigesimal counting, particularly for ordinals beyond 20. This approach reflects a nuanced relationship between numerals and their linguistic context. For instance, the Welsh for 21st is "unfed ar hugain," literally translating to "first on twenty." The Cornish for 22nd, "dew warn ugensves," translates to "two on twenty," employing a similar structure. In Breton, "unan warn ugentvet" for 21st showcases the same vigesimal basis combined with prepositional phrasing.

## Conclusion

The numeral systems in Goidelic and Brythonic languages, while sharing a common Celtic origin, diverge significantly in their structure and complexity. Research into numeral systems across languages supports the idea that these systems reflect a functional need for efficient communication. In doing so, they balance the need to communicate precisely with minimal cognitive resources (Xu, Liu, & Regier).

The morphological similarities within each branch, such as the resemblance among the numerals for 'one' and 'three' in Goidelic languages (a haon, aon, nane; and a trí, trí, tree, respectively), and among 'four' and 'twenty' in Brythonic languages (pedwar/pedair, peswar, pevar/peder; and ugain, ugens, ugent, respectively), showcase a shared linguistic heritage between both branches of languages.

The use of compound forms for constructing larger numbers, a common feature in both branches helps expanding numeral systems beyond basic numerals to express larger quantities among Celtic languages. Languages from both branches utilize a consistent scheme of compound forms to form numerals above 10. In addition, Brythonic languages have numbers with grammatical gender between numbers 1 to 4 to distinguish objects of differing genders.

## Conflict of Interest

The author is not aware of any affiliations, memberships, funding, or financial holdings that might be perceived as affecting the objectivity of this review.

## References

1. Ball, M. J. *The Celtic Languages*. Routledge.
2. Fowkes, R. *The Syntax and Semantics of the Verb in Classical Greek*. University of Chicago Press.

3. Hoyte-West, M. Irish as the 21st Official Language of the European Union. *Journal of European Integration History*.
4. Jackson, K. H. *Language and History in Early Britain: A Chronological Survey of the Brittonic Languages*. Edinburgh University Press.
5. MacAulay, D. *The Celtic Languages: Contemporary Overview*. Cambridge University Press.
6. McEvoy, B., et al. The Origins and Historical Development of the Goidelic Languages. *Oxford Journal of Linguistics*.
7. Mikhailova, T. Non-Indo-European Lexical Elements in the Celtic Languages. *Journal of Celtic Linguistics*.
8. Willis, D. *Syntactic Change in Welsh: A Study of the Loss of Verb-Second*. Oxford University Press.
9. Xu, Y., Liu, E., & Regier, T. Numeral Systems Across Languages Support Efficient Communication: From Approximate Numerosity to Recursion. *Open Mind: Discoveries in Cognitive Science*, 4, 57-70.

# Transforming Ground Search and Rescue Rover

Jonathan Peng  
Belmont, USA  
Jonathanpeng2017@gmail.com

**Abstract**—The rover mission is to conduct unmanned search and rescue in harsh and unknown environments. This paper explores the components necessary for the transforming Ground Search and Rescue Rover. Most importantly looking into the robotic arm and tracks used on the rover. By researching different systems used by Mars rovers and ATVs, A design can be formulated for the mission.

**Keywords**—autonomous rover, robotic arm, tracks

## I. GROUND SEARCH AND RESCUE ROBOTIC ARM

- a) After flying over to the specified location, the drone can land and transform into a rover. This rover will be able to traverse the terrain and complete the mission of search and rescue without needing a human driver. This will reduce the risk of accidents occurring during the mission. A robotic arm on the ground rover could be used to drill through obstacles while also providing more vision for the rover. By examining these designs on Mars Rovers, it can be understood what components are needed on the mission and what mechanisms to use. The requirements of this mission include being able to traverse quickly on the ground after landing for a search and rescue mission. This rover has to do this unmanned and be able to complete the mission efficiently. It needs to be able to go through uncharted terrain and landscapes.

### b) A. Literature Review of Similar Vehicles

- c) By analyzing vehicles with robotic arms, a design can be formulated for the ground search and rescue mission. This section will explore the Perseverance, Spirit, Opportunity, and Curiosity Mars Rovers.

#### *Perseverance Mars Rover*

Perseverance was sent to Mars to search for signs of past life and collect rock samples. The Perseverance Mars Rover is about the size of a car and contains many components to successfully complete the mission. The part that is most important to look into for ground search and rescue rover is the robotic arm. The robotic arm on the Perseverance Rover contains instruments and tools necessary to search on Mars, although many of these instruments won't be necessary for the Ground Search and Rescue rover some instruments may be used.

- 1) *Specifications:* The robotic arm on the Perseverance Mars Rover has a maximum extension range of 7 feet and the arm has five degrees of freedom as shown in Fig. 1 [1].

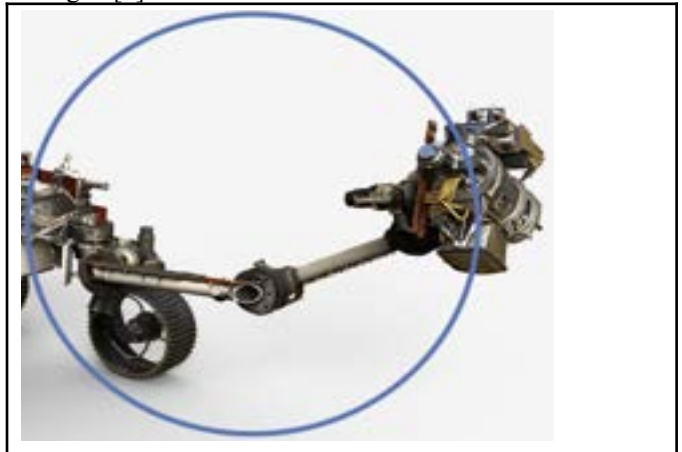

Fig. 1. Perseverance Rover Robotic Arm [1]

- 2) *Instruments on the turret:* The perseverance rover arm has a turret on the end that houses all of the important equipment used on the mission as shown in Fig. 2. The coring and regolith drill bits create 1 inch holes to extract rock cores, while the abrader bit scrapes off layers of rock. The SHERLOC and WATSON sensor studies minerals. The SHERLOC is a spectrometer that uses a laser to study minerals, while the WATSON is a camera that acts like a magnifying glass and records minerals [1]. The WATSON can also be used to get views of different rover systems such as the wheels, which can be useful if there's a problem with the rover [1]. The PIXL sensor studies changes in textures and chemicals of materials. It does this to detect possible signs of past life [1]. The GDRT (Gaseous Dust Removal Tool) is an instrument that removes particles during drilling [1]. The Ground Contact sensor prevents the arm from damaging itself if it is too low to the ground [1]. It also stops the rover if the arm is too close to the ground.

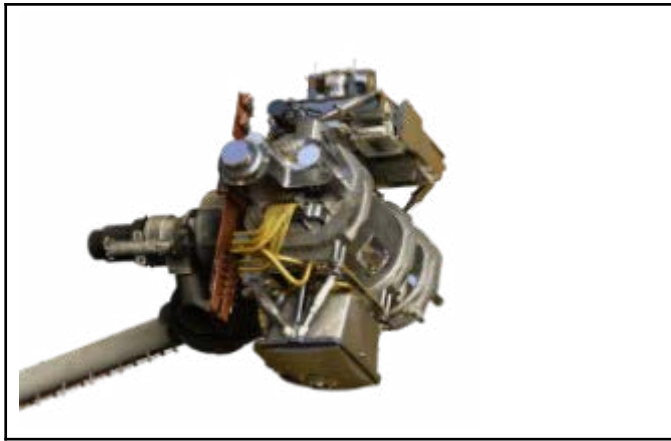

Fig. 2. The turret on the Perseverance Robotic Arm [1]

### *Spirit and Opportunity Rover*

The Spirit and Opportunity Rover were sent to Mars in search of clues about past water on Mars. Both Spirit and Opportunity contained a robotic arm that housed instruments used to complete the mission as shown in Fig. 3. Although the Spirit and Opportunity mission was only 90 days long, the engineering allowed for it to last well past the original 90-day time frame. Although the ground search and rescue mission won't need the same instruments, there are some systems that could be used as inspiration.

- 1) *Specifications:* The robotic arm has a maximum extension range of 3 feet. Three joints on the arm use a total of five motors (5 degrees of freedom) as shown in Fig. 3 [2]. The shoulder joint one motor controls side to side movement which can 160 degrees. One motor controls up and down movement which can move 70 degrees. The elbow joint moves 290 degrees folding the arm up or out. The wrist joint can move vertically and horizontally. It moves vertically 340 degrees and can twist horizontally 350 degrees [2].

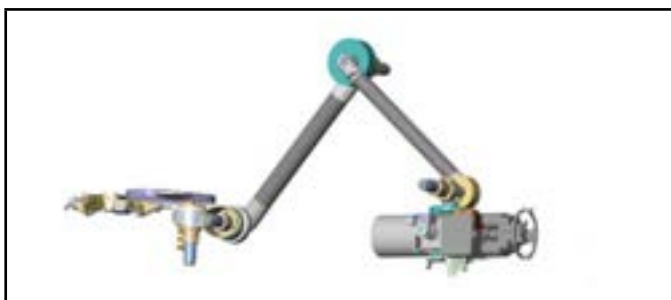

Fig. 3. Robotic arm used on the Spirit and Opportunity Rover [2]

- 2) *Instruments on the Turret:* The turret as shown in Fig. 4 houses all the important instruments used by Spirit and Opportunity. Microscopic imager provides close up images of soil for detailed analysis. The APXS sensor analyzes elements in the soil [2]. The Rock Abrasion Tool grinds away rock to reveal materials. It also has a brush which

cleans the abrasion tool before it grinds again. The Spectrometer analyzes iron in soil and rocks.

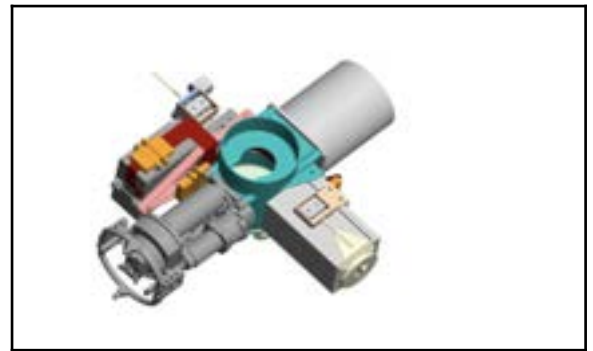

Fig. 4. Close up 3D CAD drawing of the Spirit and Opportunity's turret on the end of the robotic arm. [2]

- 3) *Spirit and Opportunity's Eyes:* Spirit and Opportunity both contain a series of cameras and sensors to help with navigation as the mission is unmanned. There are 4 Hazcams (Hazard Avoiding Cameras) which capture 3D imagery to prevent the rover from getting lost or colliding with obstacles. These cameras are statically mounted and cannot move. Each one provides a 120-degree viewing area [2]. The 4 cameras work together to map out the terrain 3 meters in each direction [2]. Mounted on the head and neck of the rover are two Navigation Cameras. These help with ground navigation. There are also two Panoramic Cameras that create three dimensional panoramas of the martian surface. There are 8 different filters for the cameras, including a solar filter which can help with navigation. The solar filter can be applied and the cameras can be pointed at the sun to navigate [2].

### *Curiosity Rover*

Curiosity was sent to Mars in search of evidence of past life. It had a robotic arm that was used to collect samples and conduct research for the mission as shown in Fig. 5. The robot arm performs rock sampling just how a human geologist would. The arm allows for precise research acting as an extension of the Rover. By exploring the details of the robotic arm on Curiosity, a robotic arm can be designed for the ground search and rescue mission.

- 1) *Specifications:* The Curiosity Rover robotic arm has 4 degrees of freedom, a maximum extension of 3 ft and a 350-degree range of motion [3]. The arm has a mass of 66 lbs and the diameter of the arm is 24 inches [3].



Fig. 5. CAD of the Curiosity Rover Robotic Arm [3]

- 2) *Instruments on the turret:* The Curiosity Rover robotic arm has a turret on the end of it that houses many of the instruments used on the mission. The APXS is a spectrometer used to analyze materials by measuring the abundance of chemicals in rocks and soil on Mars [3]. MAHLI is an instrument that allows the rover to take close up pictures and do analysis [3]. The instrument can take pictures at scales smaller than the diameter of a human hair. The CHIMRA is an instrument used to sort rocks and scoop them for analysis [3]. It has tools to sieve and portion samples of rock. The Drill system on the Curiosity rover is used to drill samples. It creates bores that are up to 2 inches long. DRT (dust removal) is an instrument used to remove the dust that is produced from drilling [3].

## II. GROUND SEARCH AND RESCUE TRACKS

When deciding whether to use wheels or tracks, the mission requirements have to be kept in mind. Tracks in this case would be more beneficial as they are more reliable in harsh environments. All terrain vehicles (ATV) or utility task vehicles (UTV) usually have 4 sets of tracks instead of wheels. UTVs have bigger back tracks which accounts for the greater weight on UTVs. The design will utilize a similar system to ATVs with 4 sets of tracks that are smaller and more equal sized. Below are certain types of tracks that are common to ATVs.

### A. Literature review of similar track designs

- d) By analyzing similar track designs, a design can be formulated for the tracks on the ground search and rescue mission. This section will explore the Camso X4S Track System, PowerFlex Trax, and EZ ATV Tracks.

#### *Camso X4S Track System:*

Camso X4S tracks are built for all types of ATVs or small UTVs. The Camso X4S tracks are built for 300cc ATVs. It uses internal drive which means that the motors are not directly mounted to the tracks. The solid steel frame

provides for better front steering and structure [4]. There is one main drive wheel on the top that is connected to the axle of the vehicle. The other wheels are used as guides for the track.

- 1) *Specifications:* The length of the front tracks is 40 inches while the back tracks are slightly longer at 42.5 inches. The height of the front tracks are slightly taller at 23.8 inches while the back tracks are 23.2 inches tall. The width of the tracks is 22 inches [4]. The slight curve on the front tracks provides for a more stable ride compared to that of a flat track as shown in Fig. 7.



Fig. 6. Left: Camso X4S back tracks. Right: Camso X4S front tracks [4]

#### *PowerFlex Trax:*

These tracks are used mainly on the back of vehicles. The full suspension system on the bottom wheels, as shown in Fig. 7, provides for a smooth ride. The design allows for even distribution of weight. There is a main drive wheel that is located on the top of the chassis. This wheel is connected to the axle of the vehicle and it moves the tracks. Similarly to the other designs the other wheels provide structure for the track as it spins.

- 2) *Specifications:* The length of the track is 110 inches. While the height of the track is 80 inches. The ground contact width is 36 inches [5].



Fig. 7. PowerFlex Trax back tracks. [5]

#### *EZ ATV Tracks:*

EZ ATV tracks are designed for 4 wheel drive ATVs. An important thing to keep track of is that these tracks have no suspension system. As shown in Fig. 8 there is one main drive wheel and 5 other support wheels. The frame is made out of aluminum [6]. There is a wheel located at the top of the track where the axle is connected to. This provides the power needed to spin the tracks and move the vehicle. Like the other two designs the wheels on the bottom wheels provide structure for the track as it spins.

- 1) *Specifications:* The EZ ATV tracks have a weight of 121 lbs. The track width is 13 inches. The height and length of the track is unknown.



Fig. 8. EZ ATV Tracks [6]

### III. PROPOSED GROUND SEARCH AND RESCUE DESIGN

Based on the previous designs shown in parts I and II, a design can be formulated. When designing the ground search and rescue rover the mission goal has to be kept in mind. The rover should be able to quickly and efficiently navigate harsh and unknown environments to search for people. There are two parts that will be focused on the robotic arm and the tracks.

#### A. Robotic Arm Design

The ground search and rescue mission is not the same as the Mars Rover missions however, some of the instruments on these rovers could be used on the mission. The ground search and rescue mission robotic arm needs to fulfill multiple criteria. The robotic arm needs to have enough maneuverability to cut through obstacles while also being lightweight enough to reduce the amount of weight during landing and takeoff. A lightweight but strong design with multiple degrees of freedom needs to be achieved. The arm will also need to carry the weight of the camera(s) and a drill. The position of the arm on the rover will be at the back side, and the base of the arm will be mounted sideways. As shown in Fig. 9. there will be two positions of the arm: the retracted and extended position. The retracted position will be used during takeoff, landing and flying. While the extended position will be the typical position during the ground mission.

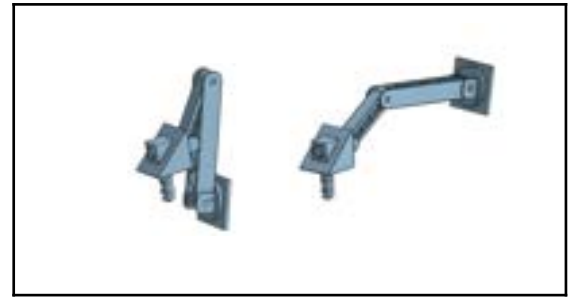

Fig. 9. CAD of the Ground Search and Rescue Robotic Arm. Retracted Position on the left and Extended Position on the right.

- 1) *The Hand:* The hand is located at the end of the Robotic Arm. On the hand will be a drill with similar design to the drill on the three rovers discussed above that could be used on our mission. A drill would enable the robot to cut through obstacles that are in the way. This would give the robot more flexibility. The drill could also be used to help lift the rover over rocks or free the rover when it is stuck. The drill on the robotic Arm for the ground search and rescue mission will be located on the hand as shown in Fig. 9. Having a camera or a set of cameras on the robotic arm would give the rover a greater field of vision. The Camera on the Robotic Arm will be mounted on the hand of the Arm as shown in Fig. 9. It will allow the rover to search in hard to reach areas. However the weight has to be balanced so that the arm is still easy to move. Many of the instruments of the Mars rovers won't be needed, such as the spectrometers, however a ground contact sensor could be useful in preventing damages while driving.
- 2) *Specifications:* 4 degrees of freedom will provide enough maneuverability for the drill and cameras while also allowing the arm to fold during takeoff and landing. The arm would have to be lightweight but strong enough to carry the load of the turret. A material such as aluminum or carbon fiber would be a good fit as they both have high strength to weight ratios. The base as shown in Fig. 9 of the robotic arm will be on a turning platform that will be powered by a motor. The three joints as shown in Fig. 9 of the arm will be powered by servos, as servos provide for accurate movements. Two of these joints will be the two sections of the arm, and the last joint controls the movement of the hand.

#### B. Tracks Design

By taking into consideration the different designs a design that incorporates multiple aspects of each one will create the best end result. Having four sets

of tracks is the best design for the rover. The curved front tracks and flat backtracks will be the most beneficial as it will give the rover good maneuverability while also providing stability. The flat back tracks will provide the traction needed for movement while the curved front tracks will allow the rover to move over obstacles. Instead of having a steering system, a tank drive with four motors will be used on the rover as steering would not be possible with 4 tracks. A tank drive turns by powering different configurations of motors at different speeds so that the rover turns. The drive wheel is the top most wheel on the track as shown in Fig. 10. The motors attached to these wheels are shown in Fig. 11. It is also important to have suspension on the bottom wheels as the terrain could be rocky. The suspension is shown in Fig. 10 on the first small wheel. This will allow the rover to more easily traverse obstacles. It is important that the placement of the suspension also keeps the belt tensioned at all times.

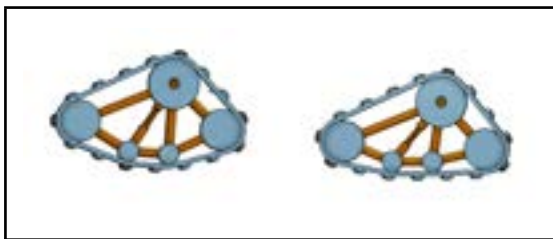

Fig. 10. Side view of the front and back tracks

This research paper explores different robotic arms designs on Mars Rovers, and also explores different track system designs. Then by compiling these designs a proposed design for the ground search and rescue mission is proposed. The ground search and rescue rover will be able to traverse difficult and unfamiliar terrain efficiently after landing, and will be able to takeoff after the mission is complete.

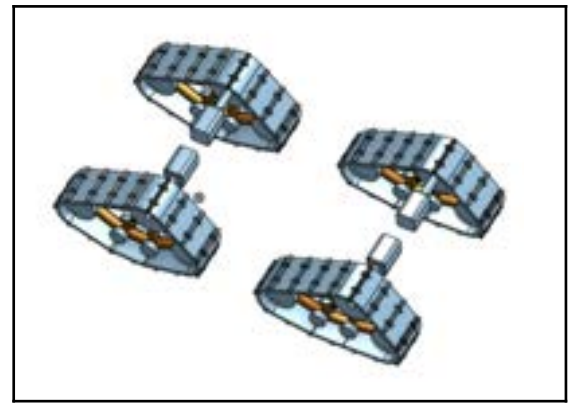

Fig. 11. Isometric view of the tracks and the motors.

#### IV. CONCLUSION

#### REFERENCES

- [1] mars.nasa.gov, "Robotic Arm," mars.nasa.gov, 2020. <https://mars.nasa.gov/mars2020/spacecraft/rover/arm/> (accessed Mar. 21, 2024).
- [2] mars.nasa.gov, "The Rover's," Nasa.gov, 2019. <https://mars.nasa.gov/mer/mission/rover/arm/> (accessed Mar. 21, 2024).
- [3] mars.nasa.gov, "Arm | Rover," NASA's Mars Exploration Program. <https://mars.nasa.gov/msl/spacecraft/rover/arm/> (accessed Mar. 22, 2024).
- [4] "Camso X4S ATV/UTV Track System | Buy Camso X4S at the Best Price." CAMSO ATV / UTV TRACK SYSTEMS, [atvtracksystems.com/atv-track-systems/camso-x4s-atv-utv-track-system/](https://atvtracksystems.com/atv-track-systems/camso-x4s-atv-utv-track-system/). Accessed 31 Mar. 2024.
- [5] ("PowerFlex Trax | ATI Rubber Track Systems")
- [6] "Mattracks | EZ Series ATV & Side by Side Tracks," [mattracks.co](https://mattracks.co/tracks/ez/). <https://mattracks.co/tracks/ez/> (accessed Apr. 14, 2024)